

# V and W Series

**Multipurpose Power Line RFI Filter for Emission Control and High-Noise Industrial Environments**

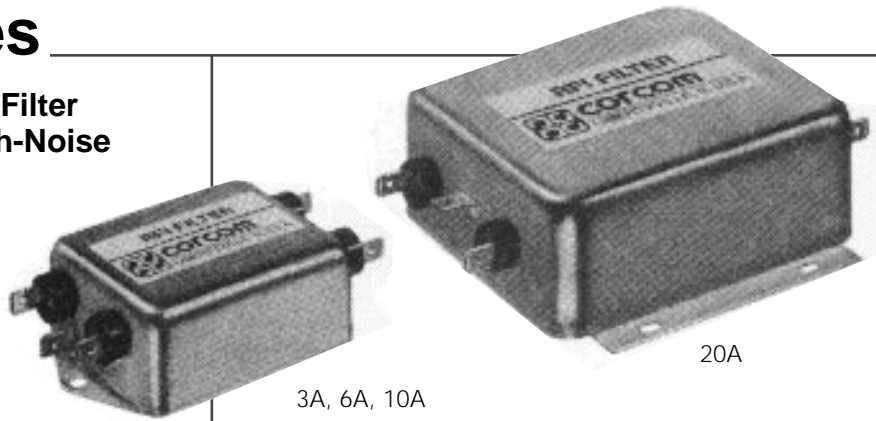

**UL Recognized  
CSA Certified  
VDE Approved**



## V and W Series

The V series and W series filters will protect equipment from malfunctions due to conducted interference coming into the equipment from the line, especially line-to-line noise and transients. They will also provide needed noise suppression to allow most equipment to meet FCC specifications for conducted emissions.

**V Series** – offers an N = 3 (“T”) line-to-ground impedance to common mode and an N = 5 (“Dbl. Pi”) impedance for line-to-line differential mode interference. The filters are designed for susceptibility use when equipment impedance at RF frequencies is low.

**W Series** – provides an N = 4 (“Dbl. L”) line-to-ground impedance for common mode and an N = 5 (“Dbl. Pi”) impedance for line-to-line differential mode interference. The filters are designed for use when equipment impedance at RF frequencies is high. The two-stage construction provides excellent suppression at high frequency.

V series and W series filters are also effective to control emissions in equipment using SCR and T<sup>2</sup>L circuits, for compliance with FCC Part 15, Subpart J, and EN55022, Level A, down to 150kHz.

## Electrical Schematics

Resistor location for reference only.

### V Series

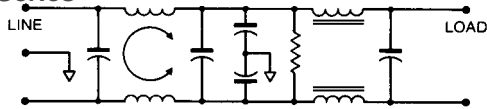

### W Series 3A, 6A, 10A

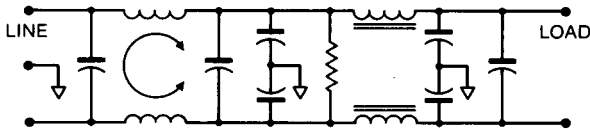

### W Series 20A

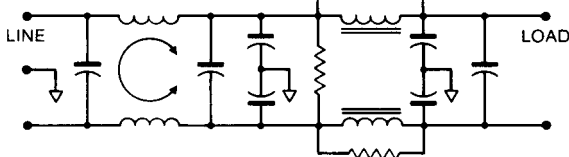

## Specifications

Maximum leakage current, each  
line-to-ground @ 120 VAC 60 Hz: 0.5 mA  
@ 250 VAC 50 Hz: .82 mA

Hipot rating (one minute):  
line-to-ground 2250 VDC  
line-to-line 1450 VDC

Operating frequency: 50/60 Hz

Rated voltage: 120/250 VAC

Rated current:	@ 120 VAC	@ 250 VAC
	3VV/3VW	3A
6VV/6VW	6A	5A
10VV/10VW	10A	8A
20VV/20VW	20A	16A

**Minimum insertion loss in dB:**

Line-to-ground in 50 ohm circuit

Current Rating	Frequency-MHz							
	.15	.5	1	2	5	10	20	30

### V Series

3A	15	27	38	47	55	55	50	48
6A	15	27	28	47	55	55	50	48
10A	15	27	38	47	55	55	50	48
20A	15	30	41	49	60	46	36	30

### W Series

3A	13	25	20	45	65	65	65	63
6A	18	30	34	40	65	65	57	47
10A	18	30	34	40	65	65	57	47
20A	18	30	34	40	65	65	57	47

Line-to-line in 50 ohm circuit

Current Rating	Frequency-MHz							
	.15	.3	.5	1	2	5	10	20

### V Series

3A	25	25	65	65	63	60	52	50	50
6A	40	54	65	65	65	65	60	57	55
10A	25	25	65	65	63	60	52	50	50
20A	25	25	65	65	63	60	52	50	50

### W Series

3A	25	40	65	65	65	62	55	35	35
6A	30	54	65	65	65	60	55	38	38
10A	25	25	65	65	65	65	50	45	45
20A	25	25	65	65	65	65	50	45	45

# Series V and W

## Case Styles

Metric shown in italics.

### 3A, 6A, 10A

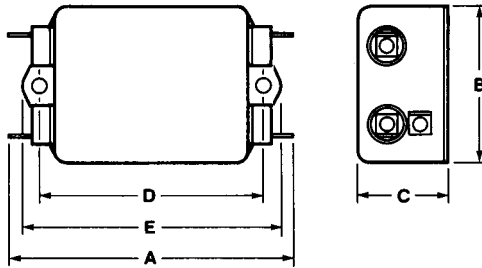

Typical dimensions

Terminals:  $\frac{.250}{6.35}$  (5) Holes:  $\frac{.07}{1.8}$  Dia. (4) Slot:  $\frac{.07 \times .16}{1.8 \times 4.1}$

Mounting holes:  $\frac{.188}{4.78}$  Dia. (2)

### 20VV1/20VW1

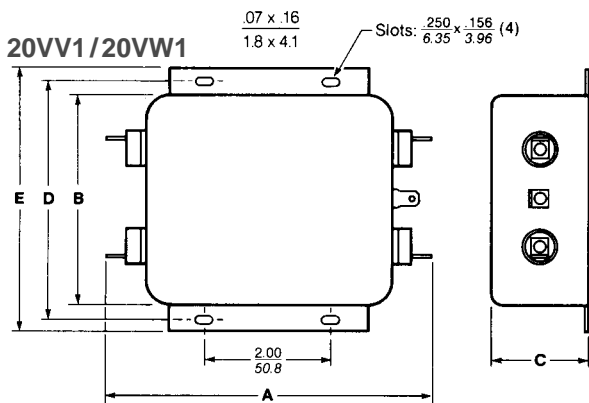

Typical dimensions

Terminals:  $\frac{.250}{6.35}$  (5) Holes:  $\frac{.07}{1.8}$  Dia. (4) Slot:  $\frac{.07 \times .16}{1.8 \times 4.1}$

### 20VV6/20VW6

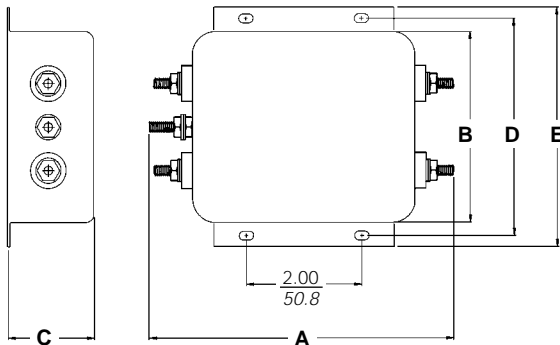

Terminals: No. 8-32 (5) Mounting slots:  $\frac{.250}{6.35} \times \frac{.156}{3.96}$  (4)  
Torque:  $18 \pm 2$  in.lb.

### 20VW7

6-32 Insert  
2 PLCS.

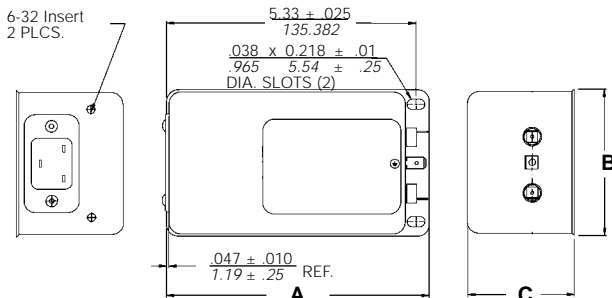

## 20VW7 Panel Cutout

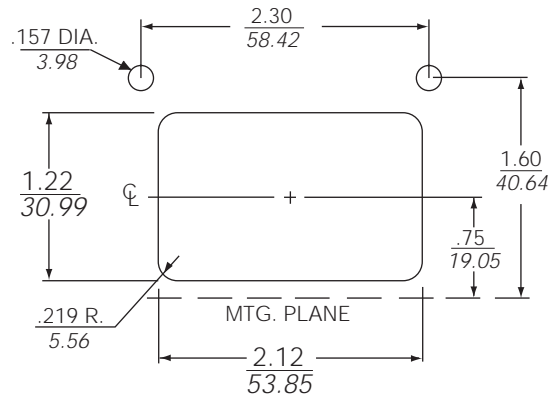

## Case Dimensions

Metric shown in italics.

Part No.	A (max)	B (max)	C (max)	D $\pm .015$ $\pm .38$	E (max)
3VV1, 3VW1	$\frac{3.36}{85.3}$	$\frac{1.82}{46.2}$	$\frac{1.28}{32.5}$	$\frac{2.375}{60.33}$	$\frac{2.78}{70.6}$
6VV1, 6VW1	$\frac{3.86}{98.0}$	$\frac{2.08}{52.8}$	$\frac{1.53}{38.9}$	$\frac{2.938}{74.63}$	$\frac{3.34}{84.8}$
10VV1, 10VW1	$\frac{3.86}{98.0}$	$\frac{2.08}{52.8}$	$\frac{1.53}{38.9}$	$\frac{2.938}{74.63}$	$\frac{3.34}{84.8}$
20VV1, 20VW1	$\frac{5.23}{132.8}$	$\frac{3.38}{85.9}$	$\frac{1.53}{38.9}$	$\frac{3.75}{95.25}$	$\frac{4.2}{106.7}$
20VV6, 20VW6	$\frac{5.34}{135.64}$	$\frac{3.38}{85.9}$	$\frac{1.53}{38.9}$	$\frac{3.76}{95.5}$	$\frac{4.2}{106.7}$
20VW7	$\frac{5.65}{143.51}$	$\frac{3.12}{79.25}$	$\frac{2.29}{58.17}$		

## Pricing

Consult your local Corcom sales representative for pricing.

Part No.	Part No.
<b>V Series</b>	<b>W Series</b>
3VV1	3VW1
6VV1	6VW1
10VV1	10VW1
20VV1	20VW1
20VV6	20VW6
	20VW7

V  
W  
79