

XF Series

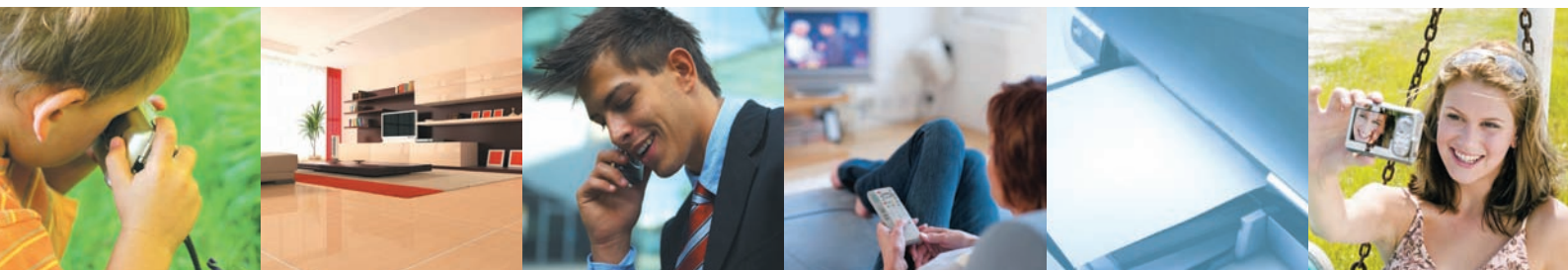

Connect to your future Applications.



XF3A

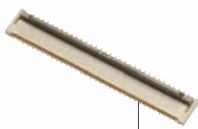

XF3B



XF3C

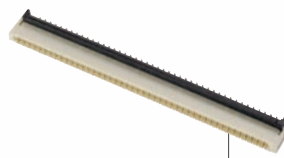

XF3E



XF3H



XF2B



XF2J



XF2L

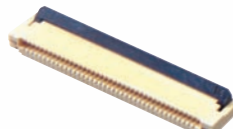

XF2M



XF2U













XF2W

FPC See How Far FPC Connectors Have Advanced

INDEX

Product Overview

Model	Lock mechanism	Pitch	On-board height	Depth (*4)	Applicable FPC/FFC thickness	Contact type	Page
 FOR FPC XF3C	Rotary backlock	0.25mm	0.85mm	3.8mm	0.12mm	Dual contact	P6
 FOR FPC XF3A	Rotary backlock	0.3mm	0.6mm	3.8mm	0.12mm	Upper contact	P7
 FOR FPC XF3B	Rotary backlock	0.3mm	0.9mm	4.0mm *3	0.2mm	Dual contact	P8
 FOR FPC XF3E	Rotary backlock	0.3mm	1.1mm	4.3mm	0.2mm	Dual contact	P9
 FOR FPC XF2B	Rotary backlock	0.3mm	1.2mm	5.5mm	0.2mm	Dual contact *1	P10
 FOR FPC XF3H	Rotary frontlock	0.3mm	0.9mm	3.5mm	0.2mm	Lower contact	P11
 FOR FPC XF2U	Rotary backlock	0.5mm	0.9mm	3.5mm	0.2mm	Dual contact	P12
 FOR FPC/FFC XF2W	Rotary backlock	0.5mm	1.1mm	3.5mm *3	0.3mm	Dual contact	P13
 FOR FPC/FFC XF2M	Rotary backlock	0.5mm	2.0mm *2	5.9mm *2	0.3mm	Dual contact	P14
 FOR FPC XF2L	Slide lock	0.5mm	1.2mm	3.45mm	0.3mm	Upper/lower contact	P15
 FOR FPC XF2J	Slide lock	0.5mm	4.15mm *5	3.45mm	0.3mm	Single-sided contact	P16

*1: Models with 61 pins have upper contacts.

*2: Dimensions of multiple type is different.

*3: 4.1 mm for more than 45 pins.

*4: These are latch closed dimension.

*5: 4.25 mm for 40 pins.

Model Number Legend

* Use this legend when determining the product specifications from the model number. Choose from the model numbers listed in this catalog when ordering.

XF□□-□□□□-□□□□-□

(1) (2) (3) (4) (5) (6) (7) (8)

(1) Classification in Series
2B, 2J, 2L, 2M, 2U, 2W,
3A, 3B, 3C, 3E, 3H

(2) Number of Signal Contact Pins

(3) Signal Contact Arrangement
1: One-row, double-sided contact
2: One-row, single-sided contact
(including upper contact
and top entry)

3: One-row, single-sided contact
(lower contact)

4: Two-row, double-sided contact
5: Two-row, single-sided contact

(4) Terminal Shape

4: SMT terminals
(top entry)
5: SMT terminals
(side entry)

(5) Applicable FPC thickness

1: 0.3mm
3: 0.2mm
4: 0.12mm
5: 0.15mm

(6) Terminal Arrangement

□: Standard
1: Staggered arrangement
(forward arrangement)
2: Staggered arrangement
(backward arrangement)

(7) Plating

A: Au

(8) Special Correspondence

R100: 100pcs
*Only XF2M, XF2W
E: Easy lock type
H: For multiple pins

Applications



■ Mobile phones

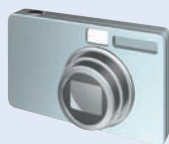

■ Digital cameras



■ Digital music players



■ Storage Device



■ Digital video cameras



■ LCD-TV, PDP-TV



■ Ultra sound



■ Electricity meter



■ Surveillance camera

Features of Rotary Backlock Mechanism

Feature 1

Rotary latch independent of the FPC socket

➔ **Rotary latch does not disconnect if the FPC is lifted.**

High reliability – A mounted FPC will not come off if excess force is applied to it.

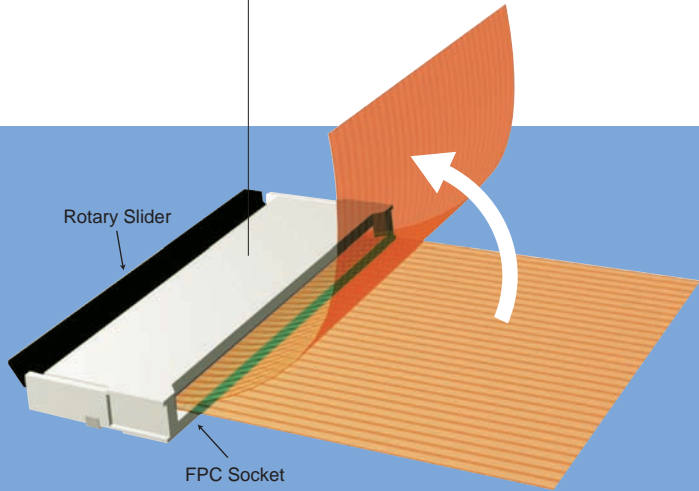

Feature 2

Four-sided housing

➔ **Construction prevents FPC displacement.**

Mounting reliability is enhanced because the FPC is held in a four-sided housing and is unaffected by the slider operation.

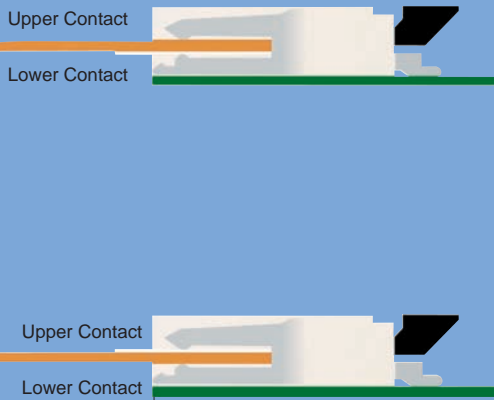
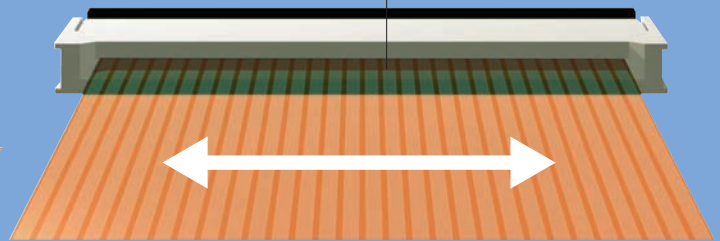

Tradition Rotary Connector

1. Mount the connector.

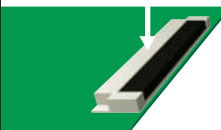

2. Release the rotary latch.

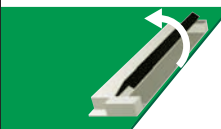

3. Insert the FPC.

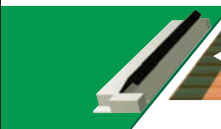

4. Lock the rotary latch.



XF2 Series

1. Mount the connector.

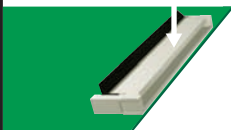

2. Insert the FPC.

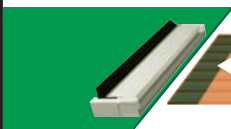

3. Lock the rotary slider.



Feature 3

Dual contact

* Except the XF3A series and XF2B-61 pin.

➔ **No need to discriminate between the upper and lower FPC connection.**

It's no necessary to distinguish between the upper and lower contacts when connecting upper and lower PCBs.

Feature 4

Delivered with the rotary latch open.

➔ **Reduces the operation.**

Compared with traditional rotary lock connector, it is no need for latch unlock operation that improves your operation.

Introduction of Product

OMRON delivers cutting-edge innovative products a step ahead of customer needs. Please look forward to the continuing development of our new products.

XF3A Ultra-slim FPC Connectors

Ultra-low profile with an on-board height of 0.6mm.

- Ultra-low construction supports LCR downsizing.
- The rotary back lock ensures operability.
- Halogen free.

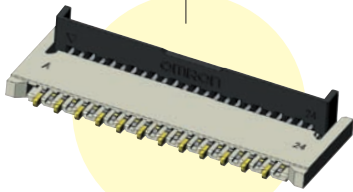

● ZIF structure with 0.6mm on-board height



● Contribute to Downsizing of Mobile Devices

Possible to downsize compare with existing connectors.

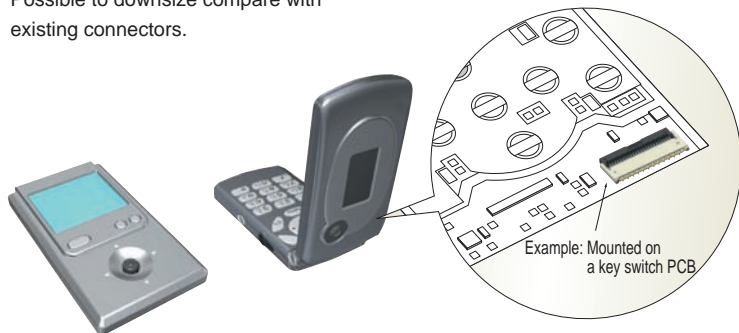

● Connector Specifications

Pitch	0.3mm
Height	0.6mm
Depth	3.8mm
FPC thickness	0.12mm
Contact orientation	Upper contact
Lock mechanism	Rotary backlock

XF3C 0.25mm Pitch FPC Connector

0.25mm pitch Dual contact type

- Contributing to miniature mobile Devices.
- Dual contact reduces the number of parts.
- The rotary backlock ensures operability.
- Halogen free.



● Dual contact connector with 0.25mm pitch

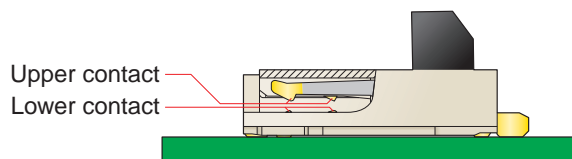

● Single sided FPC with an applicable thickness of 0.12mm

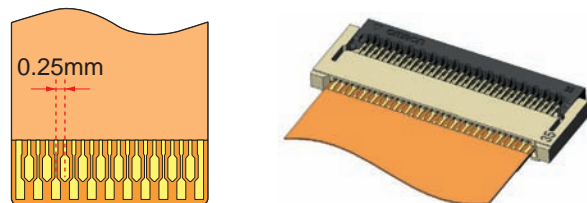

● Connector Specifications

Pitch	0.25mm
Height	0.85mm
Depth	3.8mm
FPC thickness	0.12mm
Contact orientation	Dual contact
Lock mechanism	Rotary backlock

● Decreased 20% of mounting area, compared with our 0.3mm pitch connector

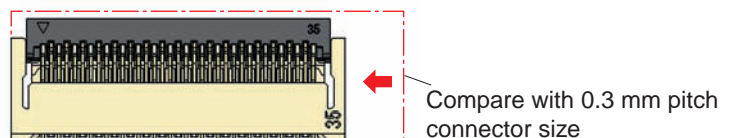

XF3C

For FPC

Rotary Backlock Connector (0.25-mm Pitch, Dual Contact)

0.25 mm Pitch with Dual contact and Rotary Backlock Mechanism

- Wide molding wall on the rear bottom of the connector allows greater freedom in board design.
- Dual contact.
- Single sided FPC with an applicable thickness of 0.12 mm.
- Halogen Free (*)

* OMRON uses the following standard to determine halogen-free construction: 900 ppm max. for Br, 900 ppm max. for Cl, and 1,500 ppm max. for Br+Cl.

RoHS compliant



■ Ratings and Specifications

Rated current	0.2 A AC/DC
Rated voltage	50 V AC/DC
Contact resistance	80 mΩ max. (at 20 mV DC max., 100 mA max.)
Insulation resistance	100 MΩ min. (at 250 V DC)
Dielectric strength	250 V AC for 1 min. (leakage current: 1 mA max.)
Insertion durability	20 times
Ambient operating temperature	-30 to 85 °C (With no icing or condensation)

■ Materials and Finish

Housing	LCP resin (UL94V-0)/natural
Slider	LCP resin (UL94V-0)/black
Contacts	Spring copper alloy/nickel substrate (2 μm) Gold-plated contacts (0.15 μm)

■ Dimensions

XF3C-□□45-41A

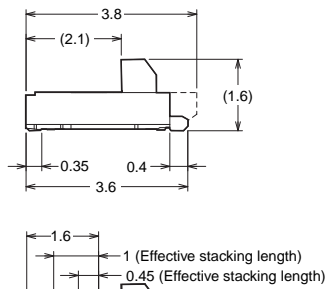
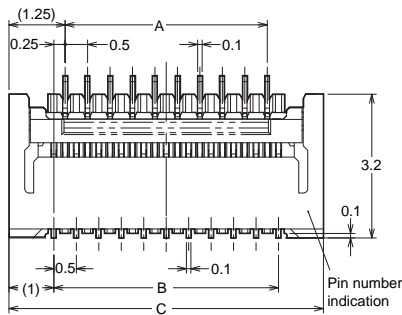

Cross-section diagram: X-X

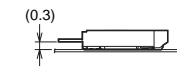

PCB Dimensions (TOP VIEW)

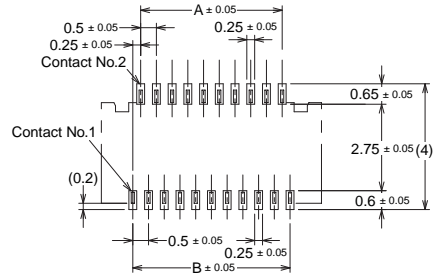

Applicable FPC Dimensions

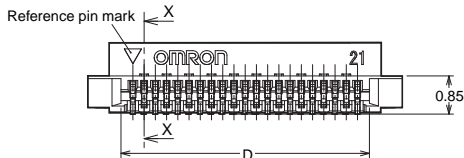
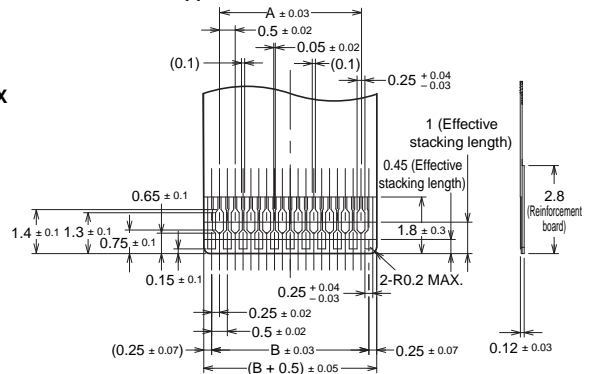

Table of Dimensions

Pins ^{*1}	Model	A	B	C	D
17	XF3C-1745-41A	3.5	4.0	6.0	4.55
19	XF3C-1945-41A	4.0	4.5	6.5	5.05
23	XF3C-2345-41A	5.0	5.5	7.5	6.05
25	XF3C-2545-41A	5.5	6.0	8.0	6.55
35	XF3C-3545-41A	8.0	8.5	10.5	9.05
45	XF3C-4545-41A	10.5	11.0	13.0	11.55
51	XF3C-5145-41A	12.0	12.5	14.5	13.05
59	XF3C-5945-41A	14.0	14.5	16.5	15.05

■ Ordering Information

Pins ^{*1}	Model	Quantity per reel (unit) ^{*2}
17	XF3C-1745-41A	2,000
19	XF3C-1945-41A	
23	XF3C-2345-41A	
25	XF3C-2545-41A	
35	XF3C-3545-41A	
45	XF3C-4545-41A	
51	XF3C-5145-41A	
59	XF3C-5945-41A	

* 1. Please consult your OMRON representative for;

- Available pin count
- Release date of pin count with bracket

* 2. Please order by integer multiple of the quantity per reel.

XF3A

For FPC

Rotary Backlock Connector (0.3-mm Pitch, Upper Contact)

On-board height 0.6 mm, the lowest class profile in the industry.
Rotary Backlock Connectors with a 0.3-mm pitch.

- Wide molding wall on the rear bottom of the connector allows greater freedom in board design.
- Upper Contact
- Halogen Free (*)

* OMRON uses the following standard to determine halogen-free construction: 900 ppm max. for Br, 900 ppm max. for Cl, and 1,500 ppm max. for Br+Cl.

RoHS compliant

■ Ratings and Specifications

Rated current	0.2 A AC/DC
Rated voltage	50 V AC/DC
Contact resistance	80 mΩ max. (at 20 mV DC max., 100 mA max.)
Insulation resistance	100 MΩ min. (at 250 V DC)
Dielectric strength	250 V AC for 1 min. (leakage current: 1 mA max.)
Insertion durability	10 times
Ambient operating temperature	-30 to 85 °C (With no icing or condensation)

■ Materials and Finish

Housing	LCP resin (UL94V-0)/natural
Slider	LCP resin (UL94V-0)/black
Contacts	Spring copper alloy/nickel substrate (2 μm) Gold-plated contacts (0.15 μm)

■ Dimensions

XF3A-□□55-41A

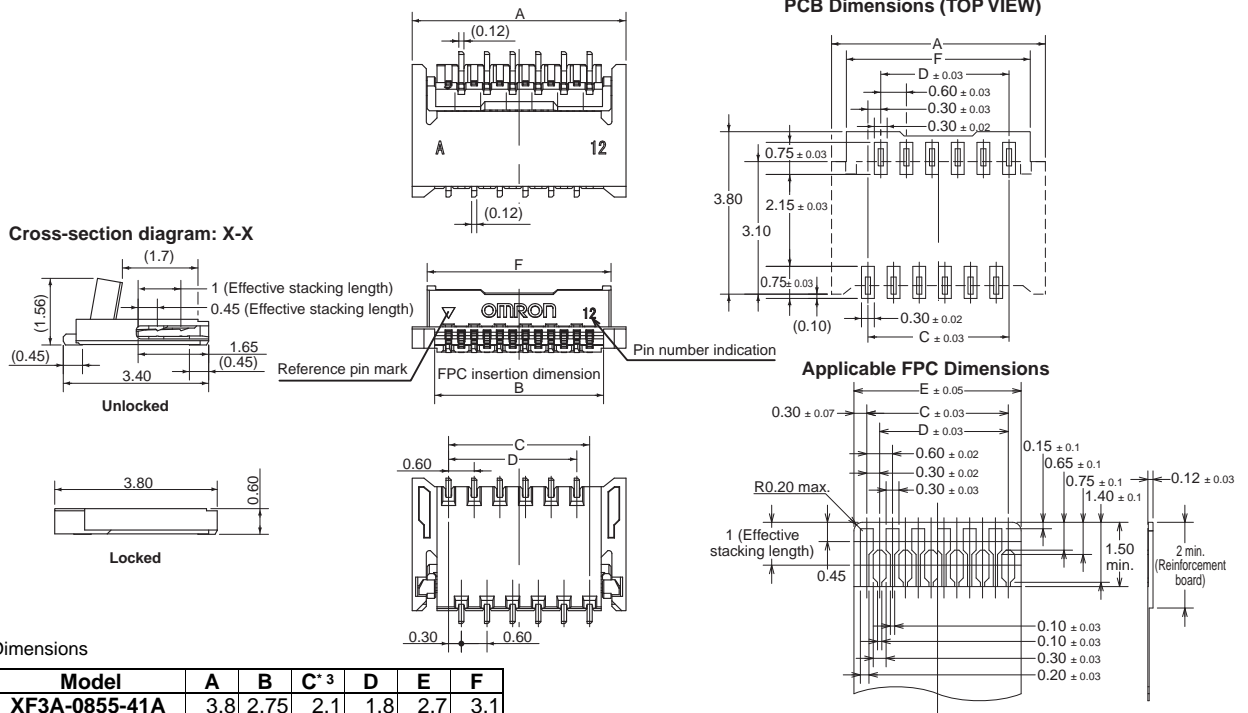

Table of Dimensions

Pins ¹	Model	A	B	C ³	D	E	F
8	XF3A-0855-41A	3.8	2.75	2.1	1.8	2.7	3.1
12	XF3A-1255-41A	5.0	3.95	3.3	3.0	3.9	4.3
17	XF3A-1755-41A	6.5	5.45	4.8	4.2	5.4	5.8
23	XF3A-2355-41A	8.3	7.25	6.6	6.0	7.2	7.6
25	XF3A-2555-41A	8.9	7.85	7.2	6.6	7.8	8.2
51	XF3A-5155-41A	16.7	15.65	15.0	14.4	15.6	16.0

■ Ordering Information

Pins ¹	Model	Quantity per reel (unit) ²
8	XF3A-0855-41A	4,000
12	XF3A-1255-41A	
17	XF3A-1755-41A	
23	XF3A-2355-41A	
25	XF3A-2555-41A	
51	XF3A-5155-41A	

- * 1. Please consult your OMRON representative for available pin count.
- * 2. Please order by integer multiple of the quantity per reel.
- * 3. Dimension C indicates total pitch.

XF3B

For FPC

Rotary Backlock Connector (0.3-mm Pitch, Dual Contact)

Compact body (with a low profile of just 0.9 mm) supports the applicable FPC thickness of 0.2 mm.

- Wide molding wall on the rear bottom of the connector allows greater freedom in board design.
- Dual contact model to enhance the contact structure of lower contact.
- Gold plated with an applicable FPC thickness of 0.2 mm.
- Halogen Free (*)

* OMRON uses the following standard to determine halogen-free construction: 900 ppm max. for Br, 900 ppm max. for Cl, and 1,500 ppm max. for Br+Cl.

RoHS compliant



■ Ratings and Specifications

Rated current	0.2 A AC/DC
Rated voltage	50 V AC/DC
Contact resistance	80 mΩ max. (at 20 mV DC max., 100 mA max.)
Insulation resistance	100 MΩ min. (at 250 V DC)
Dielectric strength	250 V AC for 1 min. (leakage current: 1 mA max.)
Insertion durability	20 times
Ambient operating temperature	-30 to 85 °C (With no icing or condensation)

■ Materials and Finish

Housing	LCP resin (UL94V-0)/natural
Slider	LCP resin (UL94V-0)/brown
Contacts	Spring copper alloy/nickel substrate (2 μm) Gold-plated contacts (0.15 μm)

■ Dimensions

XF3B-□□45-31A

XF3B-□□45-31AE

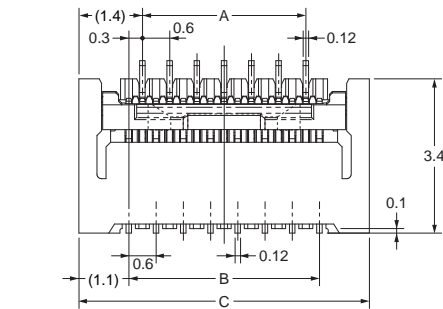

Cross-section diagram: X-X

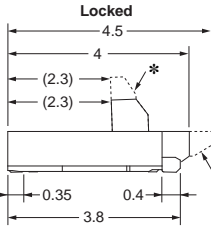
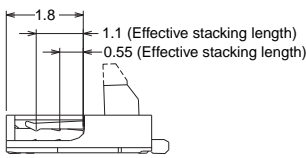

* Dotted lines indicate the shape and dimensions of the XF3B-□□45-31AE connectors.

PCB Dimensions (TOP VIEW)

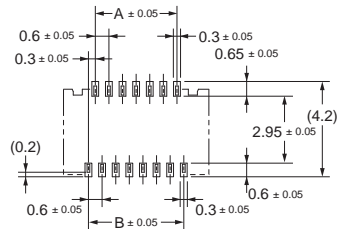

Applicable FPC Dimensions

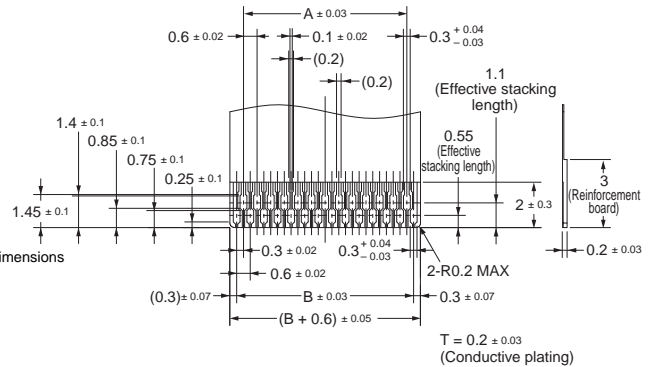

Table of Dimensions

Pins* 2	Model* 1	A	B* 4	C	D
8	XF3B-0845-31A	1.8	2.1	4.3	2.75
19	XF3B-1945-31A	4.8	5.4	7.6	6.05
25	XF3B-2545-31A	6.6	7.2	9.4	7.85
35	XF3B-3545-31A	9.6	10.2	12.4	10.85
51	XF3B-5145-31AE	14.4	15.0	17.2	15.65
67	XF3B-6745-31AE	19.2	19.8	22.0	20.45

■ Ordering Information

Pins* 2	Model* 1	Quantity per reel (unit)* 3
8	XF3B-0845-31A	2,000
19	XF3B-1945-31A	2,000
25	XF3B-2545-31A	2,000
35	XF3B-3545-31A	2,000
51	XF3B-5145-31AE	1,500
67	XF3B-6745-31AE	1,500

- * 1. The end of the model number indicates the slider specification.
None: Standard type E: Easy lock type
- * 2. Please consult your OMRON representative for available pin count.
- * 3. Please order by integer multiple of the quantity per reel.
- * 4. Dimension B indicates total pitch.

XF3E

Rotary Backlock Connector (0.3-mm Pitch, Dual Contact)

Large number of contacts with 0.3-mm Pitch and 1.1-mm On-board Height

- Rotary Backlock Connector.
- Dual contact.
- Gold plated with an applicable FPC thickness of 0.2 mm.
- Halogen Free (*)

* OMRON uses the following standard to determine halogen-free construction: 900 ppm max. for Br, 900 ppm max. for Cl, and 1,500 ppm max. for Br+Cl.

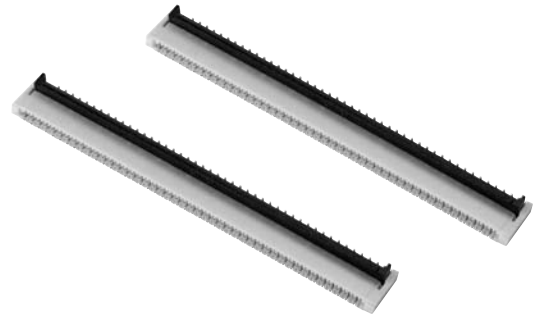

RoHS compliant

■ Ratings and Specifications

Rated current	0.2 A AC/DC
Rated voltage	50 V AC/DC
Contact resistance	80 mΩ max. (at 20 mV DC max., 100 mA max.)
Insulation resistance	100 MΩ min. (at 250 V DC)
Dielectric strength	250 V AC for 1 min. (leakage current: 1 mA max.)
Insertion durability	20 times
Ambient operating temperature	-30 to 85 °C (With no icing or condensation)

■ Materials and Finish

Housing	LCP resin (UL94V-0)/natural
Slider	LCP resin (UL94V-0)/black
Contacts	Spring copper alloy/nickel substrate (2 μm) Gold-plated contacts (0.15 μm)

■ Dimensions

XF3E-□□45-31AE

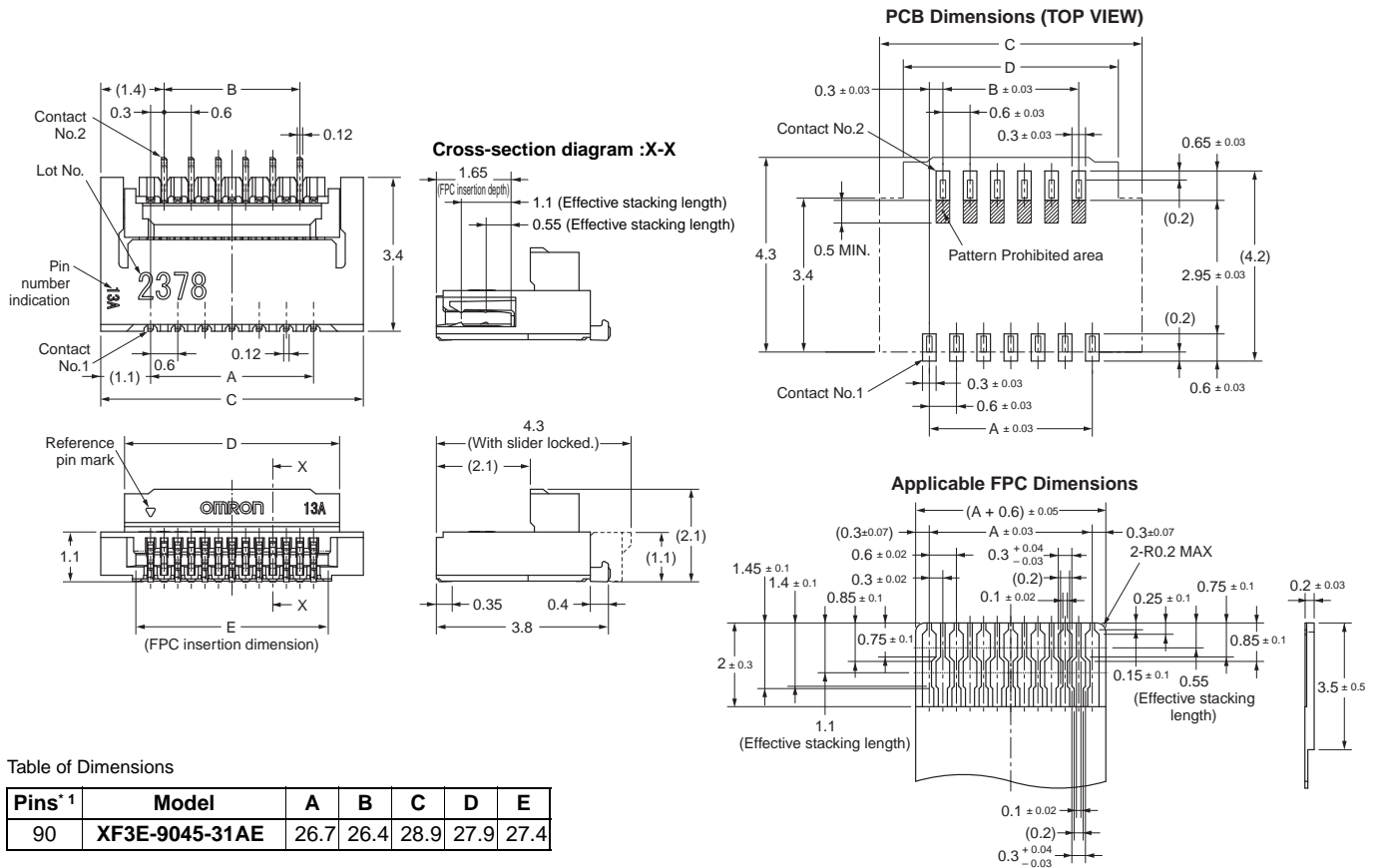

Table of Dimensions

Pins ^{*1}	Model	A	B	C	D	E
90	XF3E-9045-31AE	26.7	26.4	28.9	27.9	27.4

■ Ordering Information

Pins ^{*1}	Model	Quantity per reel (unit) ^{*2}
90	XF3E-9045-31AE	1,500

- * 1. Please consult your OMRON representative for available pin count.
- * 2. Please order by integer multiple of the quantity per reel.

XF3E

XF2B

For FPC

Rotary Backlock Connector (0.3-mm Pitch, Dual Contact)

Rotary Backlock Mechanism with 0.3-mm Pitch

- Wide molding wall on the rear bottom of the connector allows greater freedom in board design.
- Dual contact reduces the number of parts.
- Gold plated with an applicable FPC thickness of 0.2 mm.
- Halogen Free (*)

* OMRON uses the following standard to determine halogen-free construction: 900 ppm max. for Br, 900 ppm max. for Cl, and 1,500 ppm max. for Br+Cl.

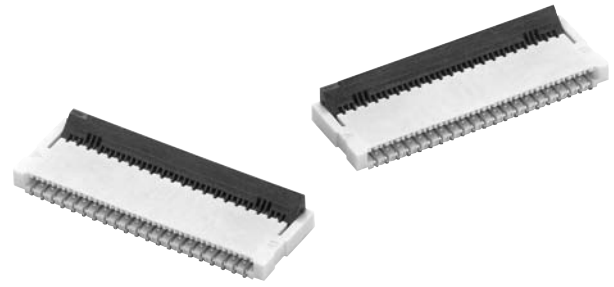

RoHS compliant

■ Ratings and Specifications

Rated current	0.2 A AC/DC
Rated voltage	50 V AC/DC
Contact resistance	50 mΩ max. (at 20 mV DC max., 100 mA max.)
Insulation resistance	100 MΩ min. (at 250 V DC)
Dielectric strength	250 V AC for 1 min. (leakage current: 1 mA max.)
Insertion durability	20 times
Ambient operating temperature	-30 to 85 °C (With no icing or condensation)

■ Materials and Finish

Housing	LCP resin (UL94V-0)/natural
Slider	LCP resin (UL94V-0)/black
Contacts	Spring copper alloy/nickel substrate (2 μm) Gold-plated contacts (0.15 μm)

■ Dimensions

XF2B-□□□5-31A

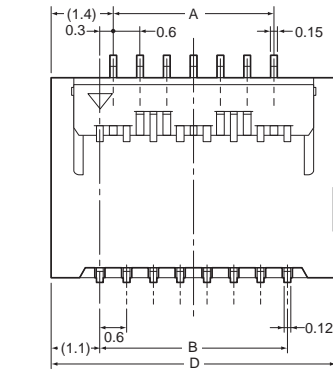

Cross-section diagram: X-X

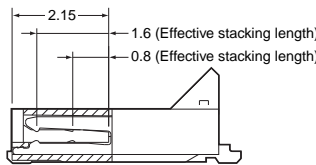

PCB Dimensions (TOP VIEW)

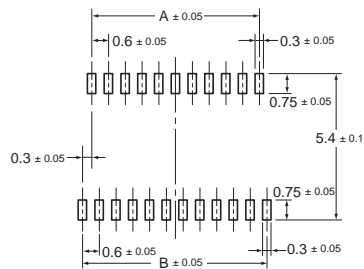

Applicable FPC Dimensions

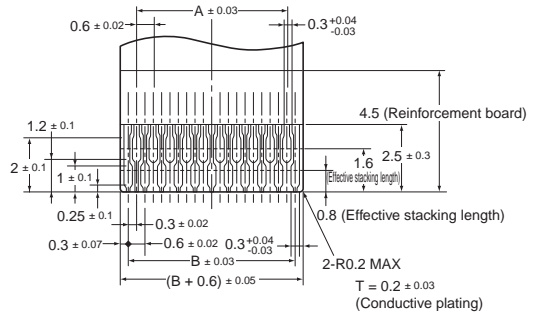

Table of Dimensions

Pins ^{*1}	Model	A	B	C	D
17	XF2B-1745-31A	4.2	4.8	5.5	7.0
21	XF2B-2145-31A	5.4	6.0	6.7	8.2
23	XF2B-2345-31A	6.0	6.6	7.3	8.8
25	XF2B-2545-31A	6.6	7.2	7.9	9.4
27	XF2B-2745-31A	7.2	7.8	8.5	10.0
31	XF2B-3145-31A	8.4	9.0	9.7	11.2
33	XF2B-3345-31A	9.0	9.6	10.3	11.8
35	XF2B-3545-31A	9.6	10.2	10.9	12.4
39	XF2B-3945-31A	10.8	11.4	12.1	13.6
41	XF2B-4145-31A	11.4	12.0	12.7	14.2
45	XF2B-4545-31A	12.6	13.2	13.9	15.4
51	XF2B-5145-31A	14.4	15.0	15.7	17.2
61	XF2B-6155-31A	17.4	18.0	18.7	20.2

■ Ordering Information

Pins ^{*1}	Model	Pins ^{*1}	Model	Quantity per reel (unit) ^{*2}
17	XF2B-1745-31A	35	XF2B-3545-31A	1,500
21	XF2B-2145-31A	39	XF2B-3945-31A	
23	XF2B-2345-31A	41	XF2B-4145-31A	
25	XF2B-2545-31A	45	XF2B-4545-31A	
27	XF2B-2745-31A	51	XF2B-5145-31A	
31	XF2B-3145-31A	61	XF2B-6155-31A ^{*3}	
33	XF2B-3345-31A	-	-	

* 1. Please consult your OMRON representative for available pin count.

* 2. Please order by integer multiple of the quantity per reel.

* 3. Upper contact.

XF3H

Rotary Frontlock Connector (0.3-mm Pitch, Lower Contact)

For FPC

Rotary Frontlock Mechanism with a Depth of 3.5-mm and Low Profile of 0.9 mm

- Ultra-slim connector with a depth of 3.5 mm.
- Wide molding wall on the rear bottom of the connector allows greater freedom in board design.
- Slider open locking mechanism makes work efficient.
- Gold plated with an applicable FPC thickness of 0.2 mm.
- Halogen Free (*)

* OMRON uses the following standard to determine halogen-free construction: 900 ppm max. for Br, 900 ppm max. for Cl, and 1,500 ppm max. for Br+Cl.

RoHS compliant

■ Ratings and Specifications

Rated current	0.2 A AC/DC
Rated voltage	50 V AC/DC
Contact resistance	80 mΩ max. (at 20 mV DC max., 100 mA max.)
Insulation resistance	100 MΩ min. (at 250 V DC)
Dielectric strength	250 V AC for 1 min. (leakage current: 1 mA max.)
Insertion durability	20 times
Ambient operating temperature	-30 to 85 °C (With no icing or condensation)

■ Dimensions

XF3H-□□55-31A

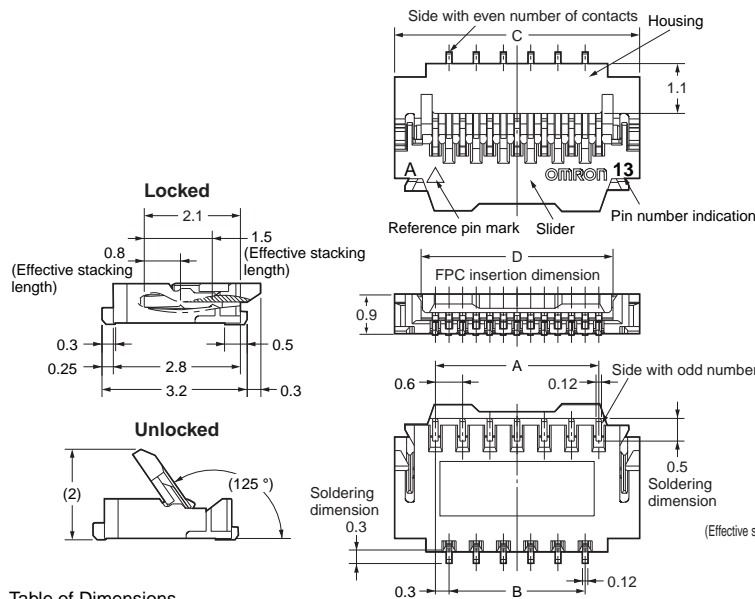
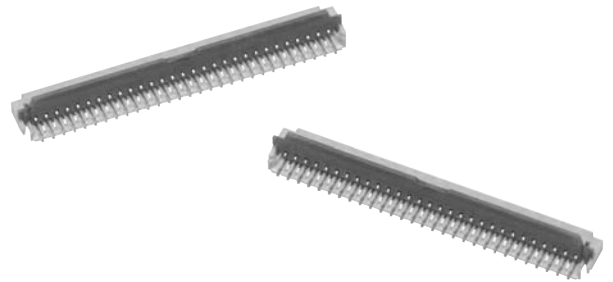

Table of Dimensions

Pins ^{*1}	Model	A	B	C	D	E
13	XF3H-1355-31A	3.6	3.0	5.4	4.23	4.2
25	XF3H-2555-31A	7.2	6.6	9.0	7.83	7.8
31	XF3H-3155-31A	9.0	8.4	10.8	9.63	9.6
35	XF3H-3555-31A	10.2	9.6	12.0	10.83	10.8
39	XF3H-3955-31A	11.4	10.8	13.2	12.03	12.0
41	XF3H-4155-31A	12.0	11.4	13.8	12.63	12.6
45	XF3H-4555-31A	13.2	12.6	15.0	13.83	13.8
51	XF3H-5155-31A	15.0	14.4	16.8	15.63	15.6
57	XF3H-5755-31A	16.8	16.2	18.6	17.43	17.4
61	XF3H-6155-31A	18.0	17.4	19.8	18.63	18.6



■ Materials and Finish

Housing	LCP resin (UL94V-0)/natural
Slider	LCP resin (UL94V-0)/brown
Contacts	Spring copper alloy/nickel substrate (2 μm) Gold-plated contacts (0.15 μm)

PCB Dimensions (TOP VIEW)

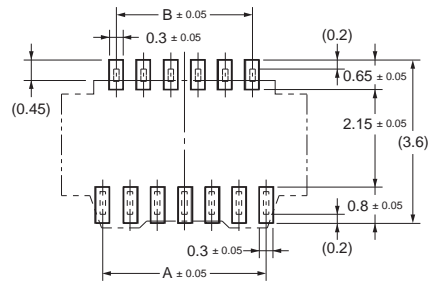

Applicable FPC Dimensions

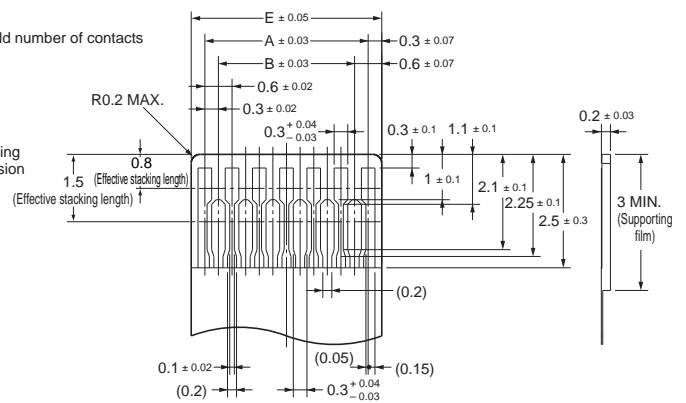

■ Ordering Information

Pins ^{*1}	Model	Pins ^{*1}	Model	Quantity per reel (unit) ^{*2}
13	XF3H-1355-31A	41	XF3H-4155-31A	3,000
25	XF3H-2555-31A	45	XF3H-4555-31A	
31	XF3H-3155-31A	51	XF3H-5155-31A	
35	XF3H-3555-31A	57	XF3H-5755-31A	
39	XF3H-3955-31A	61	XF3H-6155-31A	

- * 1. Please consult your OMRON representative for available pin count.
- * 2. Please order by integer multiple of the quantity per reel.

XF2U

For FPC

Rotary Backlock Connector (0.5-mm Pitch, Dual Contact)

Rotary Backlock Mechanism with a Depth of 3.5-mm and Low Profile of 0.9 mm

- Ultra-slim connector with a depth of 3.5 mm.
- Dual contact reduces the number of parts.
- Wide molding wall on the rear bottom of the connector allows greater freedom in board design.
- Gold plated with an applicable FPC thickness of 0.2 mm.
- Halogen Free (*)

* OMRON uses the following standard to determine halogen-free construction: 900 ppm max. for Br, 900 ppm max. for Cl, and 1,500 ppm max. for Br+Cl.

RoHS compliant

■ Ratings and Specifications

Rated current	0.5 A AC/DC
Rated voltage	50 V AC/DC
Contact resistance	60 mΩ max. (at 20 mV DC max., 100 mA max.)
Insulation resistance	100 MΩ min. (at 250 V DC)
Dielectric strength	250 V AC for 1 min. (leakage current: 1 mA max.)
Insertion durability	20 times
Ambient operating temperature	-30 to 85 °C (With no icing or condensation)

■ Materials and Finish

Housing	LCP resin (UL94V-0)/natural
Slider	LCP resin (UL94V-0)/black
Contacts	Spring copper alloy/nickel substrate (2 μm) Gold-plated contacts (0.15 μm)
Hold-down	Spring copper alloy/fused-tin plating (2 μm)

■ Dimensions

XF2U-□□15-3A

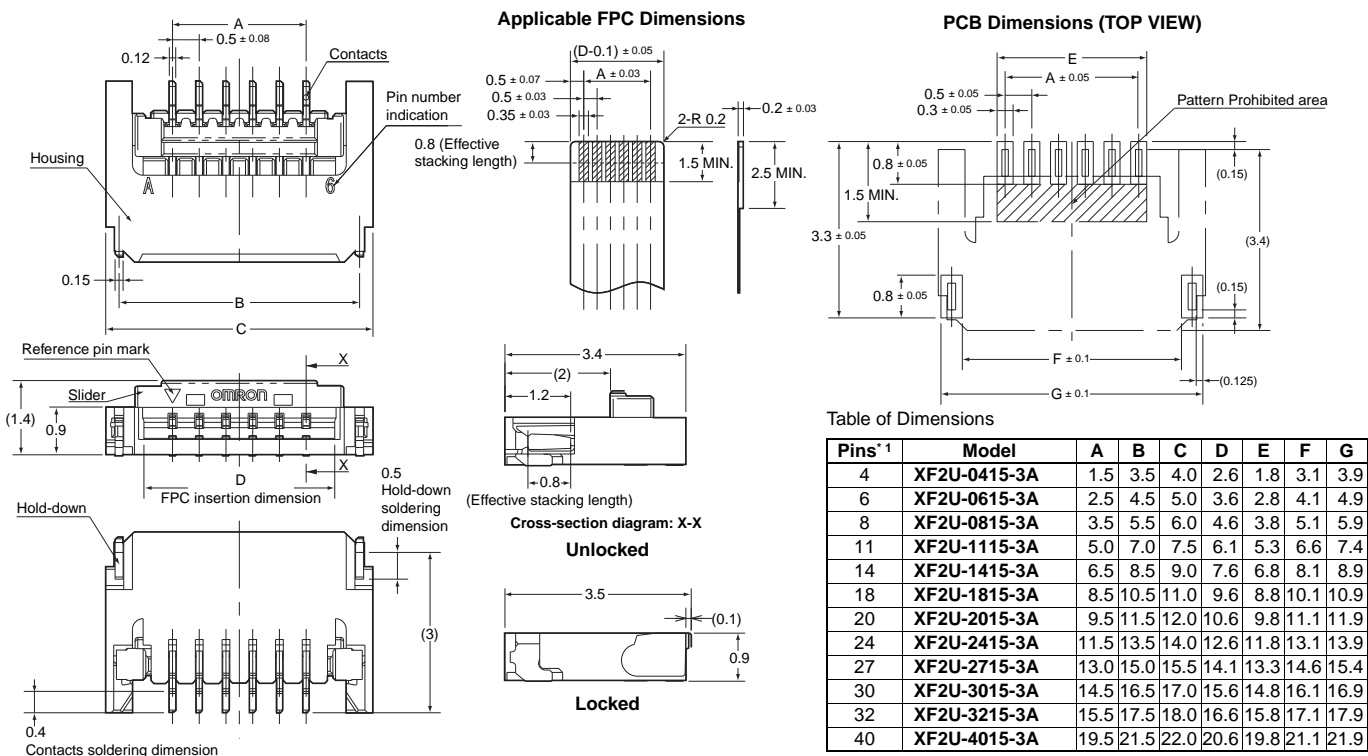

■ Ordering Information

Pins ^{*1}	Model	Quantity per reel (unit) ^{*2}
4	XF2U-0415-3A	3,000
6	XF2U-0615-3A	
8	XF2U-0815-3A	
11	XF2U-1115-3A	
14	XF2U-1415-3A	
18	XF2U-1815-3A	
20	XF2U-2015-3A	
24	XF2U-2415-3A	
27	XF2U-2715-3A	
30	XF2U-3015-3A	
32	XF2U-3215-3A	
40	XF2U-4015-3A	

- * 1. Please consult your OMRON representative for available pin count.
- * 2. Please order by integer multiple of the quantity per reel.

XF2W

Rotary Backlock Connector (0.5-mm Pitch, Dual Contact)

For FPC/FFC

Rotary Backlock Mechanism with 0.5-mm Pitch and Low Profile of 1.1 mm

- Two models available: Low profile connector with a depth of 3.5 mm and easy-operation connector with long slider.
- Dual contact reduces the number of parts.
- Wide molding wall on the rear bottom of the connector allows greater freedom in board design.
- Gold plated with an applicable FPC/FFC thickness of 0.3 mm.
- Halogen Free (*)

* OMRON uses the following standard to determine halogen-free construction: 900 ppm max. for Br, 900 ppm max. for Cl, and 1,500 ppm max. for Br+Cl.

RoHS compliant

■ Ratings and Specifications

Rated current	0.5 A AC/DC
Rated voltage	50 V AC/DC
Contact resistance	60 mΩ max. (at 20 mV DC max., 100 mA max.)
Insulation resistance	100 MΩ min. (at 250 V DC)
Dielectric strength	250 V AC for 1 min. (leakage current: 1 mA max.)
Insertion durability	20 times
Ambient operating temperature	-30 to 85 °C (With no icing or condensation)

■ Dimensions

XF2W-□□15-1A

XF2W-□□15-1AE

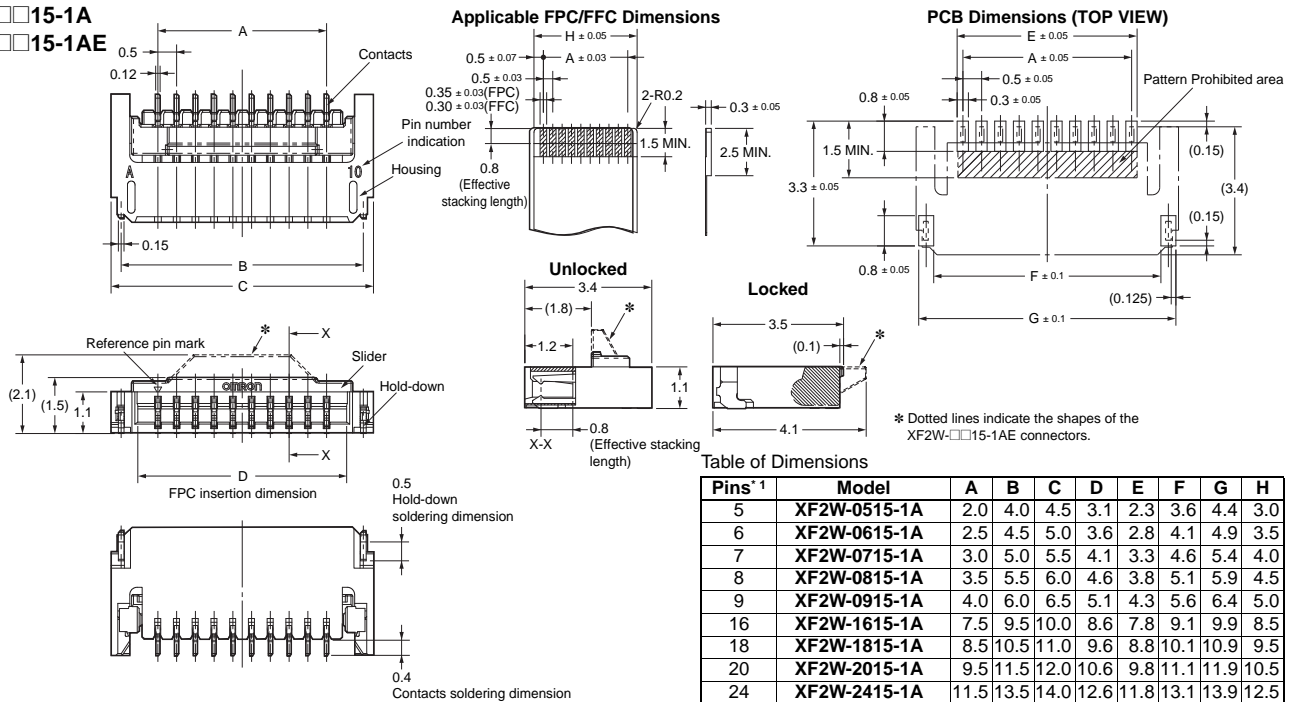

Table of Dimensions

Pins ¹	Model	A	B	C	D	E	F	G	H
5	XF2W-0515-1A	2.0	4.0	4.5	3.1	2.3	3.6	4.4	3.0
6	XF2W-0615-1A	2.5	4.5	5.0	3.6	2.8	4.1	4.9	3.5
7	XF2W-0715-1A	3.0	5.0	5.5	4.1	3.3	4.6	5.4	4.0
8	XF2W-0815-1A	3.5	5.5	6.0	4.6	3.8	5.1	5.9	4.5
9	XF2W-0915-1A	4.0	6.0	6.5	5.1	4.3	5.6	6.4	5.0
16	XF2W-1615-1A	7.5	9.5	10.0	8.6	7.8	9.1	9.9	8.5
18	XF2W-1815-1A	8.5	10.5	11.0	9.6	8.8	10.1	10.9	9.5
20	XF2W-2015-1A	9.5	11.5	12.0	10.6	9.8	11.1	11.9	10.5
24	XF2W-2415-1A	11.5	13.5	14.0	12.6	11.8	13.1	13.9	12.5
45	XF2W-4515-1AE	22.0	24.0	24.5	23.1	22.3	23.6	24.4	23.0
50	XF2W-5015-1AE	24.5	26.5	27.0	25.6	24.8	26.1	26.9	25.5
55	XF2W-5515-1AE	27.0	29.0	29.5	28.1	27.3	28.6	29.4	28.0
60	XF2W-6015-1AE	29.5	31.5	32.0	30.6	29.8	31.1	31.9	30.5
64	XF2W-6415-1AE	31.5	33.5	34.0	32.6	31.8	33.1	33.9	32.5

■ Ordering Information

100pcs per reel

Pins ¹	Model	Pins ¹	Model	Pins ¹	Model	Quantity per reel (unit) ²
5	XF2W-0515-1A-R100	16	XF2W-1615-1A-R100	50	XF2W-5015-1AE-R100	100
6	XF2W-0615-1A-R100	18	XF2W-1815-1A-R100	55	XF2W-5515-1AE-R100	
7	XF2W-0715-1A-R100	20	XF2W-2015-1A-R100	60	XF2W-6015-1AE-R100	
8	XF2W-0815-1A-R100	24	XF2W-2415-1A-R100	64	XF2W-6415-1AE-R100	
9	XF2W-0915-1A-R100	45	XF2W-4515-1AE-R100			

2000pcs per reel

Pins ¹	Model	Pins ¹	Model	Quantity per reel (unit) ²
5	XF2W-0515-1A	20	XF2W-2015-1A	2,000
6	XF2W-0615-1A	24	XF2W-2415-1A	
7	XF2W-0715-1A	45	XF2W-4515-1AE	
8	XF2W-0815-1A	50	XF2W-5015-1AE	
9	XF2W-0915-1A	55	XF2W-5515-1AE	
16	XF2W-1615-1A	60	XF2W-6015-1AE	
18	XF2W-1815-1A	64	XF2W-6415-1AE	

* 1. Please consult your OMRON representative for available pin count.

* 2. Please order by integer multiple of the quantity per reel.

XF2M

Rotary Backlock Connector (0.5-mm Pitch, Dual Contact)

For FPC/FFC

High-reliability rotary-lock and Superior Work Efficiency.

- Dual contact reduces the number of parts.
- Applicable FPC/FFC thickness of 0.3 mm.
- Halogen Free (*)

* OMRON uses the following standard to determine halogen-free construction: 900 ppm max. for Br, 900 ppm max. for Cl, and 1,500 ppm max. for Br+Cl.

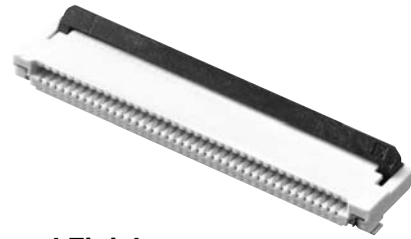

RoHS compliant

Ratings and Specifications

Rated current	0.5 A AC/DC
Rated voltage	50 V AC/DC
Contact resistance	50 mΩ max. (at 20 mV DC max., 100 mA max.)
Insulation resistance	100 MΩ min. (at 250 V DC)
Dielectric strength	250 V AC for 1 min. (leakage current: 1 mA max.)
Insertion durability	20 times
Ambient operating temperature	-30 to 85 °C (With no icing or condensation)

Materials and Finish

Housing	LCP resin (UL94V-0)/natural
Slider	LCP resin (UL94V-0)/black
Contacts	Spring copper alloy/nickel substrate (2 μm) Gold-plated contacts (0.15 μm)
Hold-down	Spring copper alloy/fused-tin plating (1.5 μm)

Dimensions

XF2M-□□15-1A
XF2M-□□15-1AH

Table of Dimensions

Pins ¹	Model	A	B	C	D	E	F	G
10	XF2M-1015-1A	4.5	5.6	8.5	9.1	7.1	6.1	9.5
12	XF2M-1215-1A	5.5	6.6	9.5	10.1	8.1	7.1	10.5
14	XF2M-1415-1A	6.5	7.6	10.5	11.1	9.1	8.1	11.5
18	XF2M-1815-1A	8.5	9.6	12.5	13.1	11.1	10.1	13.5
20	XF2M-2015-1A	9.5	10.6	13.5	14.1	12.1	11.1	14.5
22	XF2M-2215-1A	10.5	11.6	14.5	15.1	13.1	12.1	15.5
24	XF2M-2415-1A	11.5	12.6	15.5	16.1	14.1	13.1	16.5
26	XF2M-2615-1A	12.5	13.6	16.5	17.1	15.1	14.1	17.5
30	XF2M-3015-1A	14.5	15.6	18.5	19.1	17.1	16.1	19.5
32	XF2M-3215-1A	15.5	16.6	19.5	20.1	18.1	17.1	20.5
33	XF2M-3315-1A	16.0	17.1	20.0	20.6	18.6	17.6	21.0
34	XF2M-3415-1A	16.5	17.6	20.5	21.1	19.1	18.1	21.5
35	XF2M-3515-1A	17.0	18.1	21.0	21.6	19.6	18.6	22.0
36	XF2M-3615-1A	17.5	18.6	21.5	22.1	20.1	19.1	22.5
38	XF2M-3815-1A	18.5	19.6	22.5	23.1	21.1	20.1	23.5
40	XF2M-4015-1A	19.5	20.6	23.5	24.1	22.1	21.1	24.5
42	XF2M-4215-1A	20.5	21.6	24.5	25.1	23.1	22.1	25.5
45	XF2M-4515-1A	22.0	23.1	26.0	26.6	24.6	23.6	27.0
50	XF2M-5015-1A	24.5	25.6	28.5	29.1	27.1	26.1	29.5
55	XF2M-5515-1AH	27.0	28.1	31.0	31.6	29.6	28.6	32.0
60	XF2M-6015-1AH	29.5	30.6	33.5	34.1	32.1	31.1	34.5

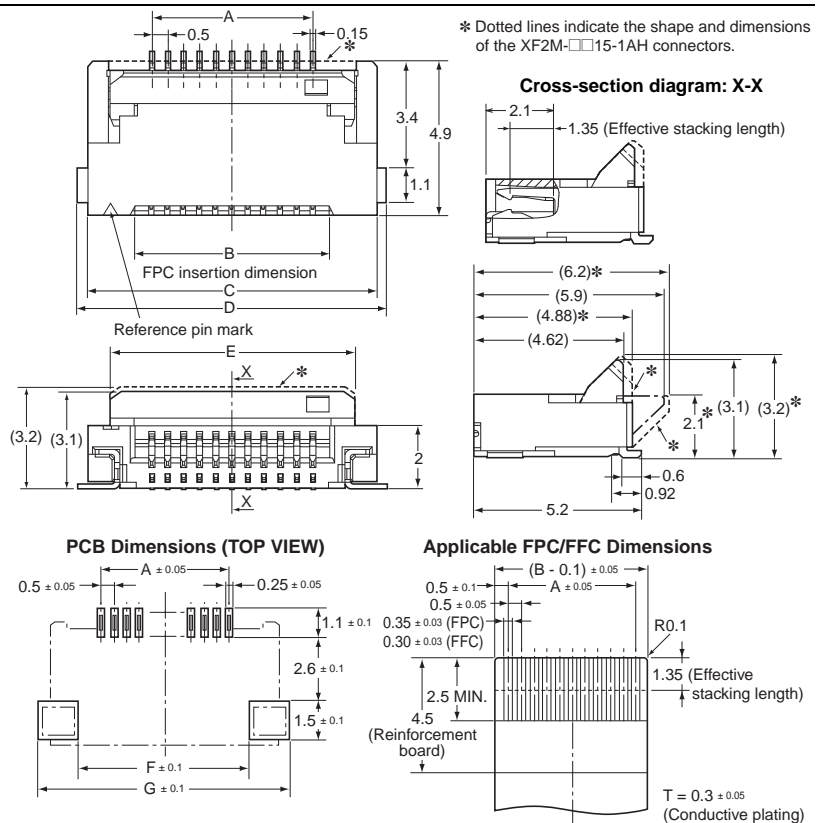

Ordering Information

100pcs per reel

Pins ¹	Model	Pins ¹	Model	Pins ¹	Model	Quantity per reel (unit) ²
10	XF2M-1015-1A-R100	26	XF2M-2615-1A-R100	38	XF2M-3815-1A-R100	100
12	XF2M-1215-1A-R100	30	XF2M-3015-1A-R100	40	XF2M-4015-1A-R100	
14	XF2M-1415-1A-R100	32	XF2M-3215-1A-R100	42	XF2M-4215-1A-R100	
18	XF2M-1815-1A-R100	33	XF2M-3315-1A-R100	45	XF2M-4515-1A-R100	
20	XF2M-2015-1A-R100	34	XF2M-3415-1A-R100	50	XF2M-5015-1A-R100	
22	XF2M-2215-1A-R100	35	XF2M-3515-1A-R100	55	XF2M-5515-1AH-R100	
24	XF2M-2415-1A-R100	36	XF2M-3615-1A-R100	60	XF2M-6015-1AH-R100	

1500pcs per reel

Pins ¹	Model	Pins ¹	Model	Pins ¹	Model	Quantity per reel (unit) ²
10	XF2M-1015-1A	26	XF2M-2615-1A	38	XF2M-3815-1A	1,500
12	XF2M-1215-1A	30	XF2M-3015-1A	40	XF2M-4015-1A	
14	XF2M-1415-1A	32	XF2M-3215-1A	42	XF2M-4215-1A	
18	XF2M-1815-1A	33	XF2M-3315-1A	45	XF2M-4515-1A	
20	XF2M-2015-1A	34	XF2M-3415-1A	50	XF2M-5015-1A	
22	XF2M-2215-1A	35	XF2M-3515-1A	55	XF2M-5515-1AH	
24	XF2M-2415-1A	36	XF2M-3615-1A	60	XF2M-6015-1AH	

1. Please consult your OMRON representative for available pin count.
2. Please order by integer multiple of the quantity per reel.

XF2L

ZIF Slide-locking Connector (0.5-mm Pitch)

For FPC

Greater Freedom in Board Design with a Bottom Wall and the Smallest On-board Area in the Industry

- Smallest on-board area and volume in the industry.
- Low on-board height of only 1.2 mm.
- Highest board design surface efficiency in the industry with a bottom wall preventing terminal exposure.
- Construction with secure slider locking mechanism.
- Applicable FPC thickness of 0.3 mm.
- Halogen Free (*)

* OMRON uses the following standard to determine halogen-free construction: 900 ppm max. for Br, 900 ppm max. for Cl, and 1,500 ppm max. for Br+Cl.



RoHS compliant

■ Ratings and Specifications

Rated current	0.5 A AC/DC
Rated voltage	50 V AC/DC
Contact resistance	30 mΩ max. (at 20 mV DC max., 100 mA max.)
Insulation resistance	100 MΩ min. (at 250 V DC)
Dielectric strength	250 V AC for 1 min. (leakage current: 1 mA max.)
Insertion durability	20 times
Ambient operating temperature	-30 to 85 °C (With no icing or condensation)

■ Materials and Finish

Item	Model	XF2L (Upper-contact Models)	XF2L (Lower-contact Models)
Housing		LCP resin (UL94V-0)/natural	
Slider		LCP resin (UL94V-0)/black	LCP resin (UL94V-0)/brown
Contacts		Spring copper alloy/nickel substrate (2 μm) Gold-plated contacts (.015 μm)	
Hold-down		Spring copper alloy/fused-tin plating (1.5 μm)	

■ Dimensions

XF2L-□□□5-1A

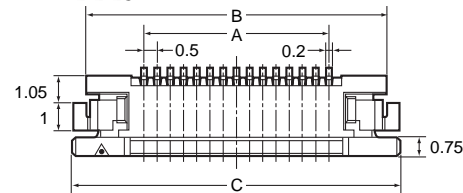

XF2L-□□25-1A (Upper-contact Models)



XF2L-□□35-1A (Lower-contact Models)



PCB Dimensions (TOP VIEW)

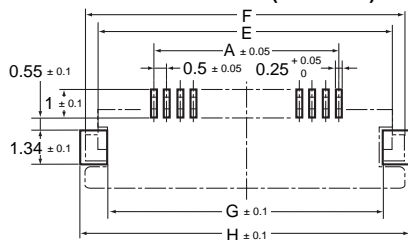

With slider open Cross-section diagram: X-X Applicable FPC Dimensions

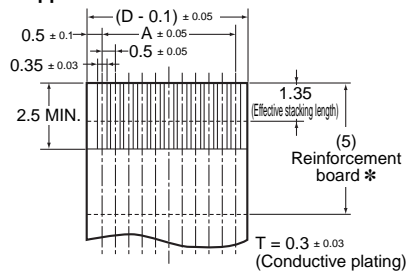

* Use polyimide and thermoset adhesive for reinforcement film material.

Table of Dimensions

Upper Contact

Pins ¹	Model	A	B	C	D	E	F	G	H
4	XF2L-0425-1A	1.5	5.9	6.9	2.6	5.88	6.88	5.28	7.28
6	XF2L-0625-1A	2.5	6.9	7.9	3.6	6.88	7.88	6.28	8.28
7	XF2L-0725-1A	3.0	7.4	8.4	4.1	7.38	8.38	6.78	8.78
8	XF2L-0825-1A	3.5	7.9	8.9	4.6	7.88	8.88	7.28	9.28
9	XF2L-0925-1A	4.0	8.4	9.4	5.1	8.38	9.38	7.78	9.78
10	XF2L-1025-1A	4.5	8.9	9.9	5.6	8.88	9.88	8.28	10.28
12	XF2L-1225-1A	5.5	9.9	10.9	6.6	9.88	10.88	9.28	11.28
13	XF2L-1325-1A	6.0	10.4	11.4	7.1	10.38	11.38	9.78	11.78
18	XF2L-1825-1A	8.5	12.9	13.9	9.6	12.88	13.88	12.28	14.28
21	XF2L-2125-1A	10.0	14.4	15.4	11.1	14.38	15.38	13.78	15.78
26	XF2L-2625-1A	12.5	16.9	17.9	13.6	16.88	17.88	16.28	18.28
30	XF2L-3025-1A	14.5	18.9	19.9	15.6	18.88	19.88	18.28	20.28

Lower Contact

Pins ¹	Model	A	B	C	D	E	F	G	H
5	XF2L-0535-1A	2.0	6.4	7.4	3.1	6.38	7.38	5.78	7.78
6	XF2L-0635-1A	2.5	6.9	7.9	3.6	6.88	7.88	6.28	8.28
7	XF2L-0735-1A	3.0	7.4	8.4	4.1	7.38	8.38	6.78	8.78
8	XF2L-0835-1A	3.5	7.9	8.9	4.6	7.88	8.88	7.28	9.28
10	XF2L-1035-1A	4.5	8.9	9.9	5.6	8.88	9.88	8.28	10.28
12	XF2L-1235-1A	5.5	9.9	10.9	6.6	9.88	10.88	9.28	11.28
13	XF2L-1335-1A	6.0	10.4	11.4	7.1	10.38	11.38	9.78	11.78
15	XF2L-1535-1A	7.0	11.4	12.4	8.1	11.38	12.38	10.78	12.78
18	XF2L-1835-1A	8.5	12.9	13.9	9.6	12.88	13.88	12.28	14.28
19	XF2L-1935-1A	9.0	13.4	14.4	10.1	13.38	14.38	12.78	14.78
20	XF2L-2035-1A	9.5	13.9	14.9	10.6	13.88	14.88	13.28	15.28
22	XF2L-2235-1A	10.5	14.9	15.9	11.6	14.88	15.88	14.28	16.28
24	XF2L-2435-1A	11.5	15.9	16.9	12.6	15.88	16.88	15.28	17.28
30	XF2L-3035-1A	14.5	18.9	19.9	15.6	18.88	19.88	18.28	20.28

■ Ordering Information

Pins ¹	List of Models	Model	Pins ¹	List of Models	Model	Pins ¹	List of Models	Model	Quantity per reel (unit) ²
4	Upper Contact	XF2L-0425-1A	10	Upper Contact	XF2L-1025-1A	19	Lower contact	XF2L-1935-1A	3,000
5	Lower contact	XF2L-0535-1A		Lower contact	XF2L-1035-1A	20	Lower contact	XF2L-2035-1A	
6	Upper Contact	XF2L-0625-1A	12	Upper Contact	XF2L-1225-1A	21	Upper Contact	XF2L-2125-1A	
	Lower contact	XF2L-0635-1A		Lower contact	XF2L-1235-1A	22	Lower contact	XF2L-2235-1A	
7	Upper Contact	XF2L-0725-1A	13	Upper Contact	XF2L-1325-1A	24	Lower contact	XF2L-2435-1A	
	Lower contact	XF2L-0735-1A		Lower contact	XF2L-1335-1A	26	Upper Contact	XF2L-2625-1A	
8	Upper Contact	XF2L-0825-1A	15	Lower contact	XF2L-1535-1A	30	Upper Contact	XF2L-3025-1A	
	Lower contact	XF2L-0835-1A		Upper Contact	XF2L-1825-1A		Lower contact	XF2L-3035-1A	
9	Upper Contact	XF2L-0925-1A	18	Lower contact	XF2L-1835-1A	-	-	-	

* 1. Please consult your OMRON representative for available pin count.

* 2. Please order by integer multiple of the quantity per reel.

XF2J

ZIF Slide-locking Connector (0.5-mm Pitch)

For FPC

Top-entry ZIF Connector.

- Low on-board height of only 4.15 mm.
- Correspond for auto-mounting, secured the pick-and-place on top of the connector.
- Models with reverse terminal arrangement also available.
- Applicable FPC thickness of 0.3 mm.



RoHS compliant

Ratings and Specifications

Rated current	0.5 A AC/DC
Rated voltage	50 V AC/DC
Contact resistance	30 mΩ max. (at 20 mV DC max., 100 mA max.)
Insulation resistance	100 MΩ min. (at 250 V DC)
Dielectric strength	250 V AC for 1 min. (leakage current: 1 mA max.)
Insertion durability	30 times
Ambient operating temperature	-30 to 85 °C (With no icing or condensation)

Materials and Finish

Housing	PA46 resin (UL94V-0)/Natural
Slider	LCP resin (UL94V-0)/black
Contacts	Spring copper alloy/nickel substrate (2 μm), Gold-plated contacts (0.15 μm)
Hold-down	Spring copper alloy/fused-tin plating (1.5 μm)

Dimensions

XF2J-□□24-1□A

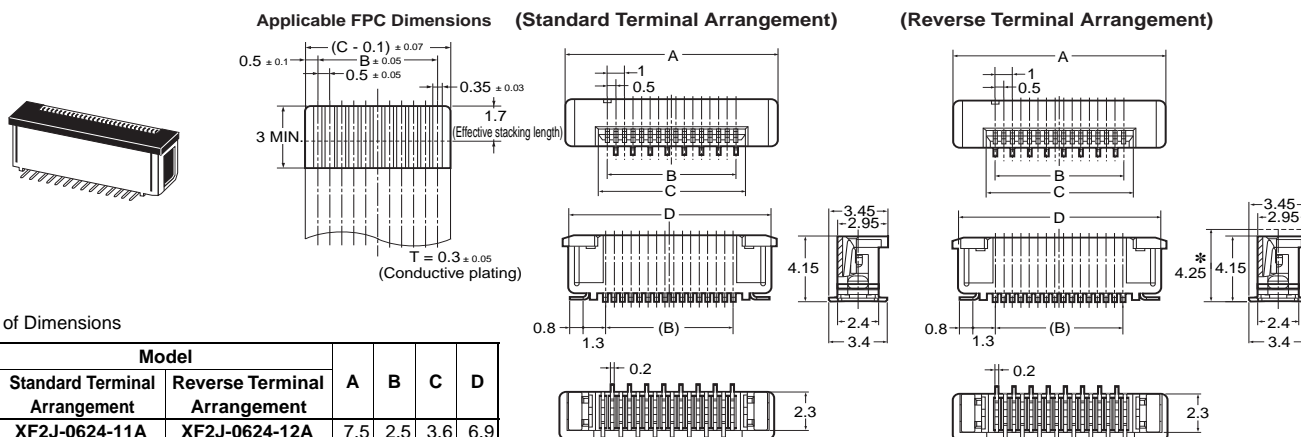

Table of Dimensions

Pins *1	Model		A	B	C	D
	Standard Terminal Arrangement	Reverse Terminal Arrangement				
6	XF2J-0624-11A	XF2J-0624-12A	7.5	2.5	3.6	6.9
8	XF2J-0824-11A	XF2J-0824-12A	8.5	3.5	4.6	7.9
10	XF2J-1024-11A	XF2J-1024-12A	9.5	4.5	5.6	8.9
12	XF2J-1224-11A	XF2J-1224-12A	10.5	5.5	6.6	9.9
14	XF2J-1424-11A	-	11.5	6.5	7.6	10.9
16	XF2J-1624-11A	XF2J-1624-12A	12.5	7.5	8.6	11.9
18	XF2J-1824-11A	XF2J-1824-12A	13.5	8.5	9.6	12.9
20	XF2J-2024-11A	XF2J-2024-12A	14.5	9.5	10.6	13.9
22	XF2J-2224-11A	XF2J-2224-12A	15.5	10.5	11.6	14.9
24	XF2J-2424-11A	XF2J-2424-12A	16.5	11.5	12.6	15.9
26	XF2J-2624-11A	-	17.5	12.5	13.6	16.9
28	XF2J-2824-11A	-	18.5	13.5	14.6	17.9
30	XF2J-3024-11A	-	19.5	14.5	15.6	18.9
40	-	XF2J-4024-12A	25.1	19.5	20.6	24.3

XF2J

Ordering Information

Pins *1	Model		Pins *1	Model		Quantity per reel (unit) ^{*2}
	Standard Terminal Arrangement	Reverse Terminal Arrangement		Standard Terminal Arrangement	Reverse Terminal Arrangement	
6	XF2J-0624-11A	XF2J-0624-12A	20	XF2J-2024-11A	XF2J-2024-12A	1,000
8	XF2J-0824-11A	XF2J-0824-12A	22	XF2J-2224-11A	XF2J-2224-12A	
10	XF2J-1024-11A	XF2J-1024-12A	24	XF2J-2424-11A	XF2J-2424-12A	
12	XF2J-1224-11A	XF2J-1224-12A	26	XF2J-2624-11A	-	
14	XF2J-1424-11A	-	28	XF2J-2824-11A	-	
16	XF2J-1624-11A	XF2J-1624-12A	30	XF2J-3024-11A	-	
18	XF2J-1824-11A	XF2J-1824-12A	40	-	XF2J-4024-12A	

* 1. Please consult your OMRON representative for available pin count.

* 2. Please order by integer multiple of the quantity per reel.

Common Precautions for XF Connectors

■ Safety Precautions

Precautions for Correct Use

For All Models

● For Operating

- Make sure that the FPC has been inserted correctly. If the FPC is inserted incorrectly from the customer's design specification, the pin number will not match and it may damage the contacts or cause malfunction of the equipment.
- Insert the FPC fully to the back of the connector. Not doing so may cause a loss of contact reliability.
- Do not lock or unlock the slider with excessive force. The connector may be damaged, and cause contact failure.
- Do not use the connector of which the slider has once come off.
- When inserting and drawing out the FPC, make sure that the slider has been unlocked first.

Using the FPC in the following ways may damage the FPC, change the shape of the contacts, or result in contact failure.

- (1) Drawing out the FPC when the slider is still locked.
- (2) Drawing out the FPC by pulling it up and down or from left to right or twisting it sideways.

● For Designing

- When mounting the connector to the FPC, design the FPC so that extreme peel force should not be applied directly on to the connector. If the FPC bends near the connector, or if the FPC is used with extreme peel force directly on to the connector, it may cause a contact loss.
- If the connector-mounted FPC is installed at a location or in any equipment that will subject the FPC to continuous shake or movement, secure the FPC or take any countermeasure against FPC disconnection from the connector.
- Use FPCs that conform to the appropriate specifications and size as stated by OMRON.

When using a different FPC, or an FFC, contact OMRON.

- Use the same metal for the FPC plating and the connector plating.
- "Whiskers" may protrude from the FPC film of some lead-free FPCs. Be careful when using these units.
- Ensure a metal mask thickness of $t = 0.12$ to 0.15 mm. The recommended metal mask open area is 90% of the printed circuit board mating dimensions given in the dimensions diagrams.

● For Mounting

- Do not mount (reflow or manual soldering) the connector to PCB with FPC inserted in the connector. Doing so may result in contact failure.
- The reflow conditions are as stated in OMRON's specifications and guidelines. These conditions, however, depend on the type of solder, the manufacturer, the amount of solder, the size of the circuit board, and the other mounting materials.
- When mounting the connector by manual soldering, observe the following precautions to ensure contact reliability.
 - (1) Conditions for manual soldering: $350 \pm 10^\circ\text{C}$ 3 ± 1 sec
 - (2) Do not apply an excessive amount of solder. Excessive solder will cause the flux to rise.
 - (3) Do not apply the soldering iron to the mount attachments using force. Doing so may cause the connectors to change shape.

- (4) Do not apply the soldering iron to any parts of the connector other than the mount attachments. Doing so may cause the connector to change shape.

● For Board Mounting

- Be careful of board warping. The connector flatness is 0.1 mm max. A large amount of warping, however, may result in soldering faults.
- Do not apply excessive force on the connector before mounting it. The connector may be damaged, resulting in faulty contacts. Do not insert the FPC and lock the slider before mounting the connector.
- Be careful not to apply an excessive load on the board when performing the following actions. The connector may be damaged, resulting in faulty contacts.

- (1) Dividing multi-cavity boards.
- (2) Securing a board with screws.

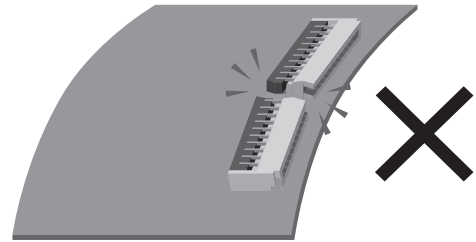

● Storage

- (1) Do not store the connectors in locations subject to dust or high humidity.
- (2) Do not store the connectors in locations close to sources of gasses such ammonia gas or sulfide gas.

For Slidelocking Models

● For Operating

- When locking the slider, apply pressure to both sides or the entire slider, then push the slider all the way in. Not doing so may result in contact failure.

● For Designing

- When designing the board, be sure to allow unlocking and operating space for the slider.

- XF2M & XF2W series are available to use FPC/FFC cable. Please check any condition of each cable in spec sheet, or contact with our Sales side.

Operating the XF Rotary Backlock

FPC connector parts

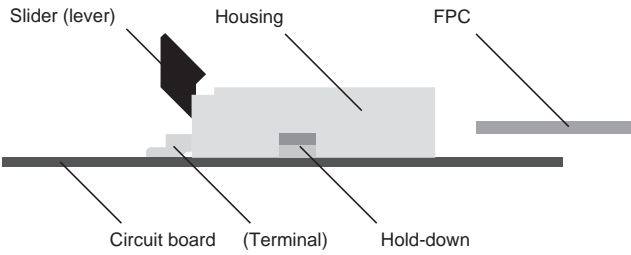

Handling Methods

● For Inserting the FPC

(1) Insert the FPC fully to the back of the connector.

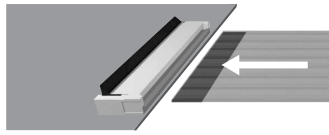

The slider (lever) shown open



(2) Activate the slider (lever) and lock the FPC in place.

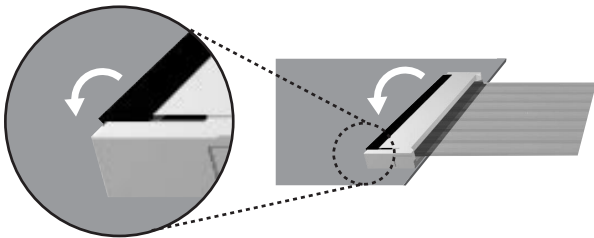

The slider (lever) shown locked

(1) Move the slider (lever) upwards to disengage the locking mechanism.

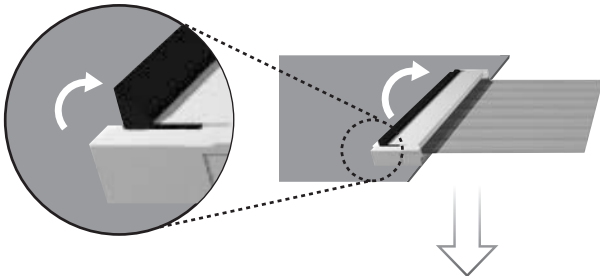

(2) Once the lock has been disengaged, pull the FPC out.

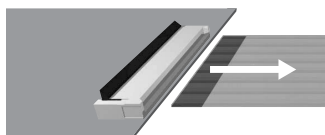

Precautions during Use

● For Operating

(1) Do not lock the slider (lever) without an FPC inserted. Locking the slider (lever) without an FPC inserted will increase the force required to insert an FPC.

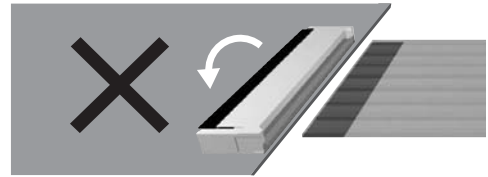

(2) Do not lock or unlock the slider (lever) with excessive force. The connector may be damaged, resulting in faulty contacts. Do not use the slider (lever) again if it becomes detached.

(3) When locking the slider (lever), apply pressure with your fingertips to both sides of the slider (lever) and then twist the slider (lever) until it comes away from the unit. Failing to lock the slider (lever) properly may result in contact failure.

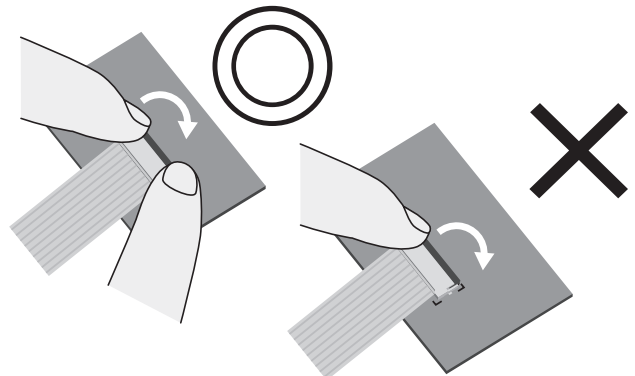

Do not apply force horizontally to the PCB when locking the slider (lever).

The connector may be damaged, resulting in faulty contacts.

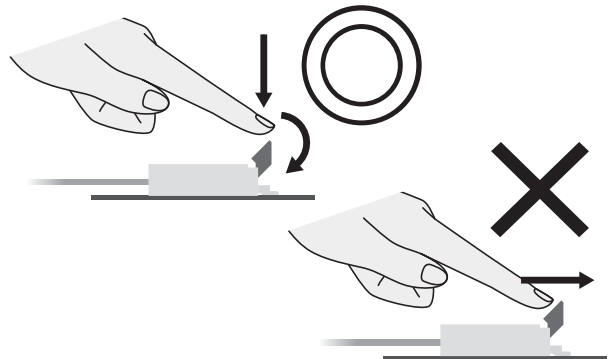

Operating the XF Rotary Backlock

(4) When unlocking the slider (lever), place your fingers on either side or the entire slider (lever) and slowly lift the slider (lever) up and away.

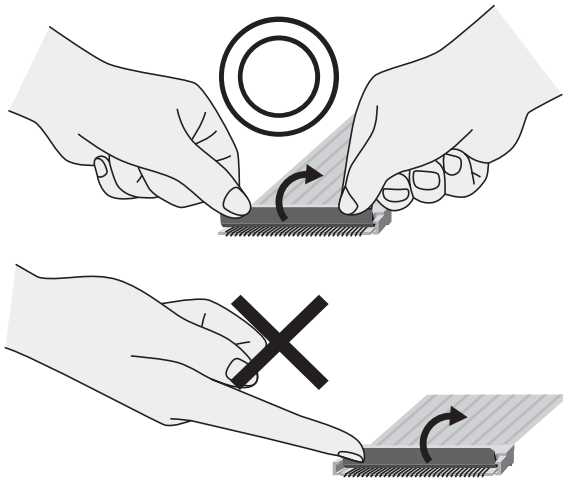

Do not engage the slider past its initial location during the unlocking process.

The connector may be damaged, resulting in faulty contacts.

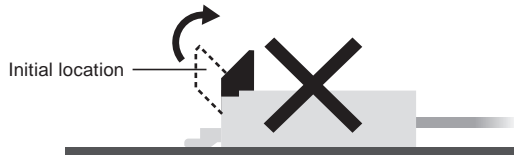

Performing the following action may cause the terminals to change shape or otherwise cause contact failures.

- Using tweezers to unlock the slider (lever).

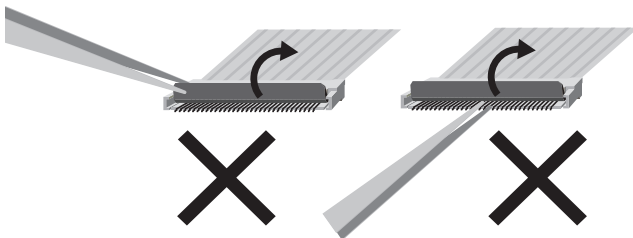

(5) When inserting and drawing out the FPC, be sure to check that the slider (lever) has been unlocked first.

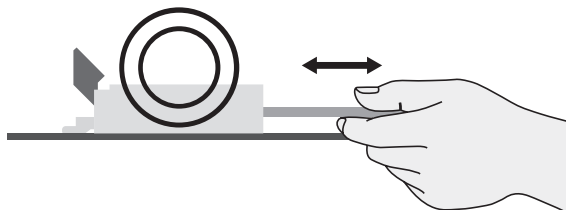

Using the FPC in the following ways may damage the FPC, change the shape of the contacts, or result in contact failure.

- Drawing out the FPC when the slider (lever) is still locked.

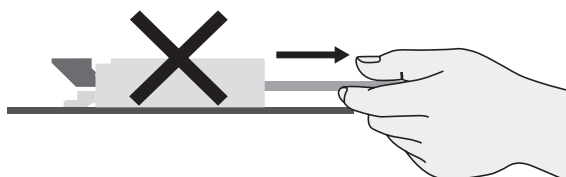

- Drawing out the FPC by pulling it up and down or from left to right or twisting it sideways.

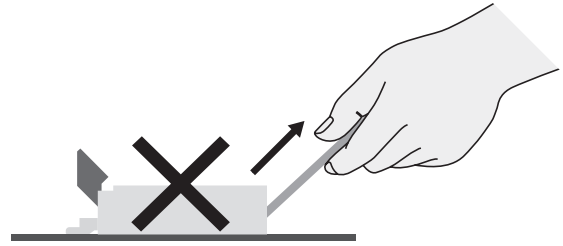

(6) Make sure that the FPC has been inserted correctly.

If the FPC is inserted incorrectly from the customer's design specification, the pin number will not match and it may damage the contacts or cause malfunction of the equipment.

- For Mounting

- (1) Do not perform reflow or manual soldering with the FPC inserted in the connector and the slider (lever) in the locked position. Doing so may result in contact failure.
- (2) The reflow conditions are as stated in OMRON's specifications and guidelines. These conditions, however, depend on the type of solder, the manufacturer, the amount of solder, the size of the circuit board, and the other mounting materials.

- For Designing

- (1) Design the FPC so that extreme peel force should not be applied directly on to the connector. If the FPC bends near the connector, or if the FPC is used with extreme peel force directly on to the connector, it may cause a contact loss.
- (2) If the FPC is installed at a location or in any equipment that will subject the FPC to continuous shake or movement, secure the FPC.
- (3) Use FPCs that conform to the appropriate specifications and size as stated by OMRON. When using a different FPC, or an FFC, contact OMRON.
- (4) Use the same metal for the FPC plating and the connector plating.
- (5) "Whiskers" may protrude from the FPC film of some lead-free FPCs. Be careful when using these units.
- (6) When designing the board, be sure to allow locking and operating space for the slider (lever).

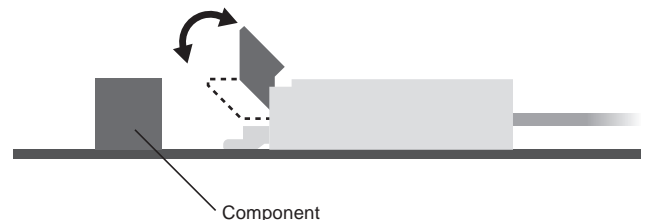

(7) Make sure that the metal mask thickness is within the appropriate specifications and size as stated by OMRON. The recommended metal mask open area is 90% of the printed circuit board mating dimensions given in the dimensions diagrams.

- XF2M & XF2W series are available to use FPC/FFC cable. Please check any condition of each cable in spec sheet, or contact with our Sales side.

Operating the XF Rotary Frontlock

FPC connector parts

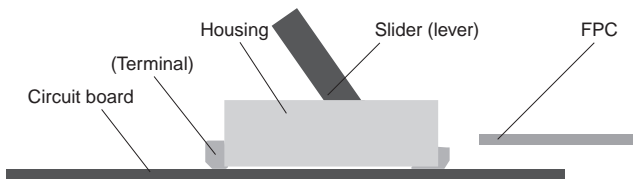

Handling Methods

● For Inserting the FPC

- (1) When unlocking the slider, use your fingernail to rotate and lift the slider.

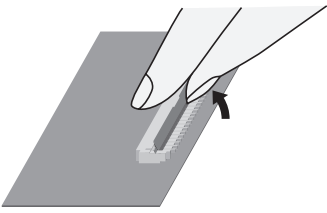

- (2) Securely insert the FPC so that it is perpendicular to the connector and horizontal to the connector.



- (3) When locking the slider, apply pressure with your fingertips to the center of the slider, then twist the slider until it comes away from the unit.

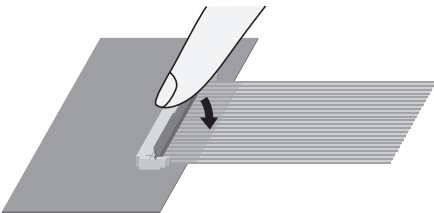

● For Drawing Out the FPC

- (1) Unlock the slider by pushing it up, then remove the FPC.

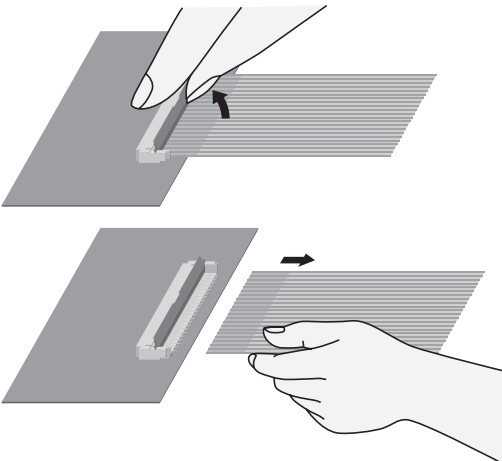

Precautions during Use

● For Operating

- (1) The slider mechanism rotates around a rotary shaft. Operate the slider in a rotating movement.

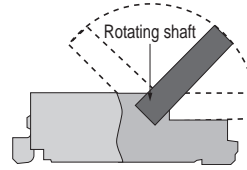

- (2) The slider cannot be opened to an angle of more than 125 degrees. Do not apply force on the slider beyond that point. The connector may be damaged, resulting in faulty contacts. Do not use the connector of which the slider has once come off.

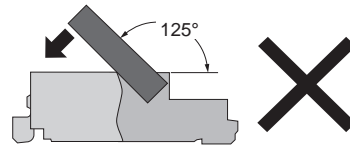

- (3) Lock and unlock the slider using the center of the slider. Using the end of the slider may result in incomplete locking, damage, or contact failure.

- (4) As shown in the following figure, do not touch the terminals with your fingernail or fingers if using the slider without the FPC inserted. Doing so may cause the terminals to change shape and result in contact failure.

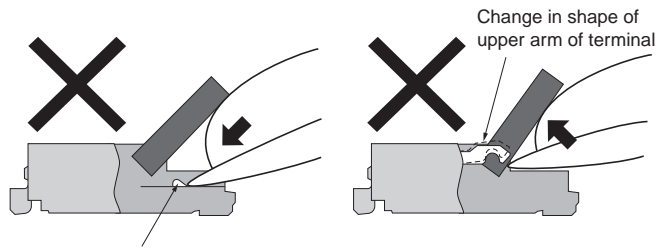

- (5) Using the FPC in the follow ways may damage the FPC, change the shape of the contacts, or result in contact failure.

- Drawing out the FPC when the slider (lever) is still locked.

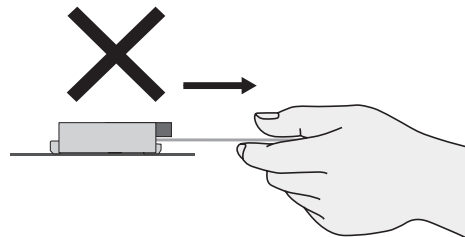

- Drawing out the FPC by pulling it up and down or from left to right or twisting it sideways.

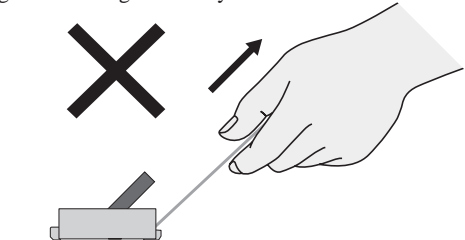

- (6) Make sure that the FPC has been inserted correctly.

If the FPC is inserted incorrectly from the customer's design specification, the pin number will not match and it may damage the contacts or cause malfunction of the equipment.

- For Mounting

- (1) Do not perform reflow or manual soldering with the FPC inserted in the connector. Doing so may result in contact failure.
- (2) The reflow conditions are as stated in OMRON's specifications and guidelines. These conditions, however, depend on the type of solder, the manufacturer, the amount of solder, the size of the circuit board, and the other mounting materials.

- For Designing

- (1) Design the FPC so that extreme peel force should not be applied directly on to the connector. If the FPC bends near the connector, or if the FPC is used with extreme peel force directly on to the connector, it may cause a contact loss.
- (2) If the FPC is installed at a location or in any equipment that will subject the FPC to continuous shake or movement, secure the FPC.
- (3) Use FPCs that conform to the appropriate specifications and size as stated by OMRON. When using a different FPC, or an FFC, contact OMRON.
- (4) Use the same metal for the FPC plating and the connector plating.
- (5) "Whiskers" may protrude from the FPC film of some lead-free FPCs. Be careful when using these units.
- (6) Make sure that the metal mask thickness is within the appropriate specifications and size as stated by OMRON. The recommended metal mask open area is 90% of the printed circuit board mating dimensions given in the dimensions diagrams.

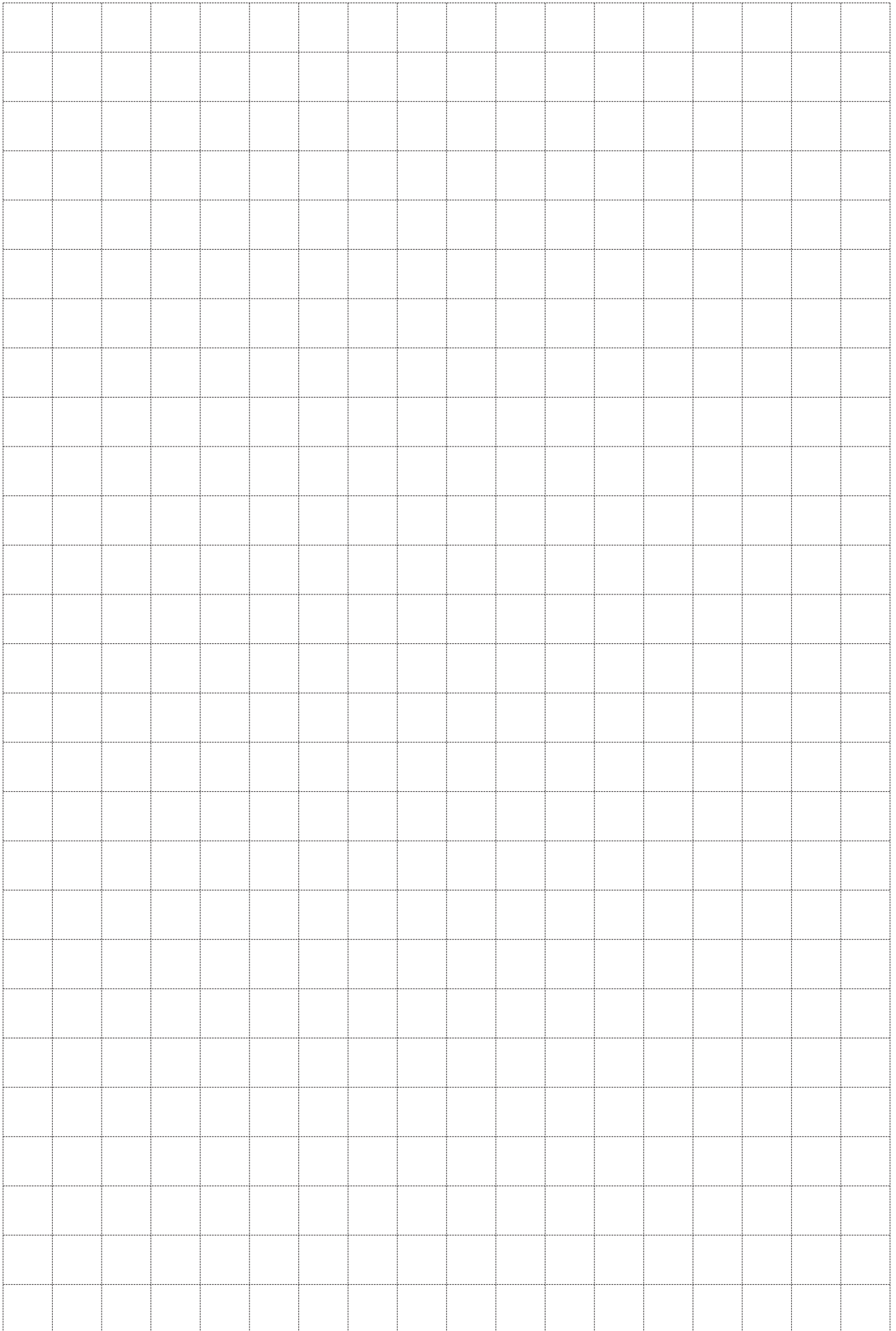

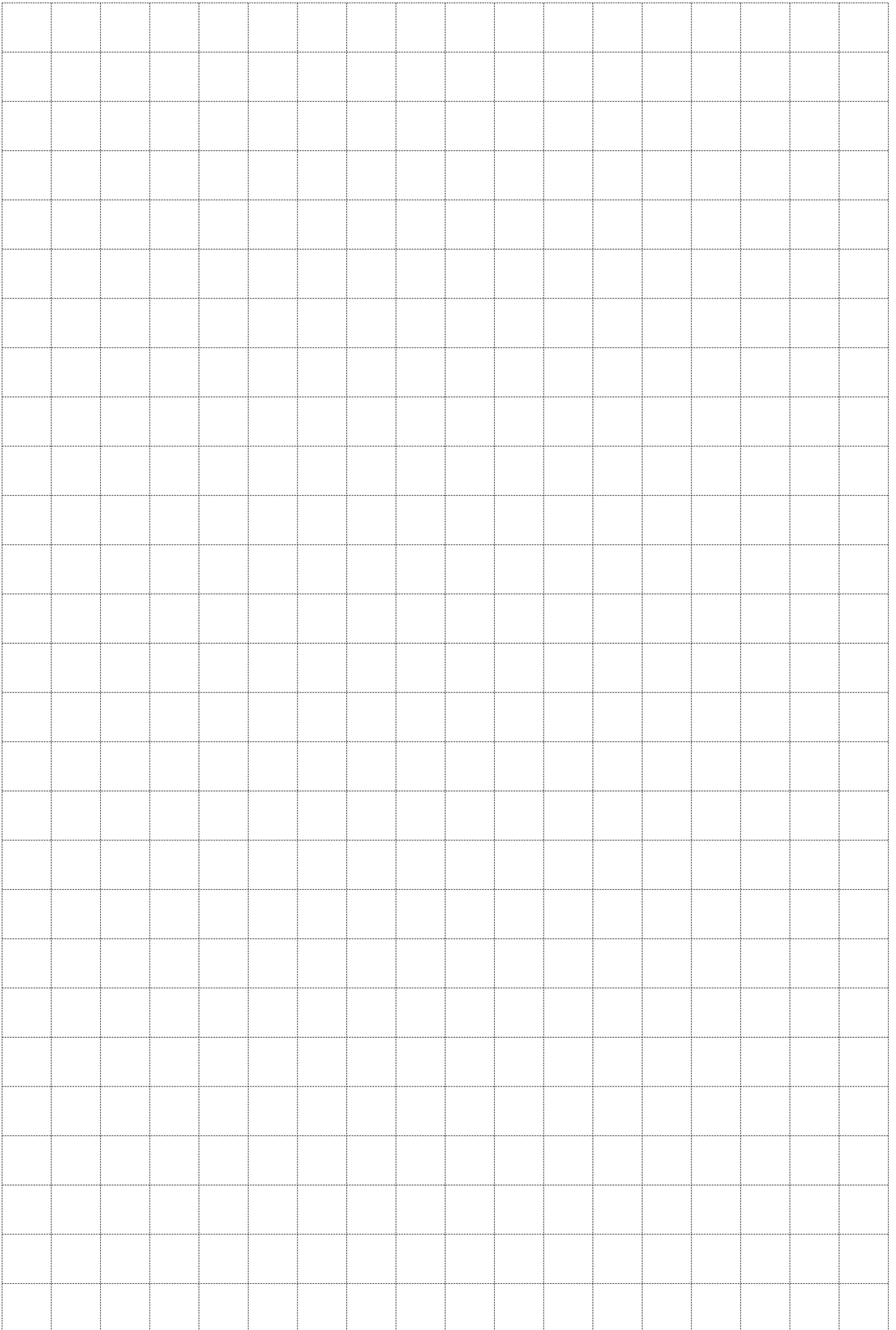

Note: Do not use this document to operate the Unit.

OMRON Corporation Electronic and Mechanical Components Company

Contact: www.omron.com/ecb

OMRON ELECTRONIC COMPONENTS EUROPE B.V.
Wegalaan 57, 2132 JD Hoofddorp, THE NETHER LANDS
Tel: (31)23-568-1200/Fax: 31-23-568-1212

OMRON ELECTRONIC COMPONENTS LLC
55 East Commerce Drive, Suite B, IL 60173 U.S.A.
Tel: (1)847-882-2288/Fax: 1-847-882-2192

OMRON ELECTRONIC COMPONENTS PTE LTD.
438A Alexandra Road #05-05/08 Alexandra
Technopark Singapore 119967
TEL:(65)6376-3200/FAX:(65)6376-3211

**OMRON ELECTRONIC COMPONENTS TRADING
(SHANGHAI) LTD. SHANGHAI OFFICE**
27F Xin Mei Union Square, 999 Pudong South Road,
Pudong New Area, Shanghai, CHINA 200120
Tel: (86)21-6859-5919/Fax: 86-21-6859-5911

OMRON ELECTRONIC COMPONENTS CO., LTD.
307, Teheran Office Bldg. #707-38,
Yeoksam-dong, Gangnam-gu, Seoul, Korea
Tel:(82)2-567-5020/Fax:(82)2-567-5804

Authorized Distributor:

© OMRON Corporation 2011 All Rights Reserved.
In the interest of product improvement,
specifications are subject to change without notice.

Cat. No. G011-E1-16

0612(0199)