

6 mm Square Long Travel 2R Light Touch Switches

Type: **EVQPV**

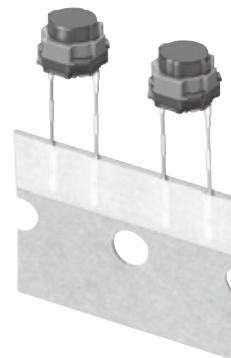

■ Features

- External dimensions : 6.0 mm×6.1 mm, Height 5.0 mm
(Including the push plate)
- High mountability, section terminals and radial taping package
- Low contact resistance and steady contact characteristics

■ Recommended Applications

- Operating switches for car electronic equipment.
- Input on operating switches for telephones, electronic musical instruments, etc.

■ Explanation of Part Numbers

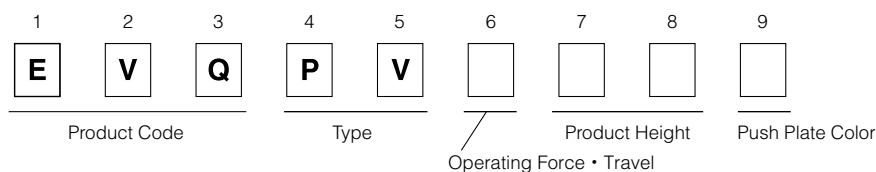

■ Specifications

Type	Snap action/Push-on type SPST	
Electrical	Rating	10 μ A 2 V DC to 50 mA 12 V DC (Resistive load)
	Contact Resistance	100 m Ω max.
	Insulation Resistance	100 M Ω min. (at 100 V DC)
	Dielectric Withstanding Voltage	250 V AC for 1 minute
	Bouncing	10 ms max. (ON, OFF)
Mechanical	Operating Force	2.2 N 1.6 N, 2.0 N, 2.5 N, 3.5 N
	Travel	1.0 mm \pm 0.2 mm 1.3 mm \pm 0.2 mm
Endurance	Operating Life	100,000 cycles min. (3.5 N type : 30,000 cycles min.)
Operating Temperature		-30 °C to +85 °C
Storage Temperature		-40 °C to +85 °C (Bulk) -20 °C to +40 °C (Taping)
Minimum Quantity/Packing Unit		2,500 pcs. Radial Taping (Reel Pack)
Quantity/Carton		25,000 pcs.

Design and specifications are each subject to change without notice. Ask factory for the current technical specifications before purchase and/or use.
Should a safety concern arise regarding this product, please be sure to contact us immediately.

■ Dimensions in mm (not to scale)

EVQPV

General dimension tolerance : ± 0.2
() dimensions are reference dimensions.

(Radial Taping)

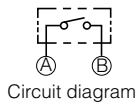
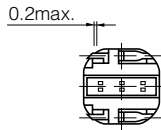
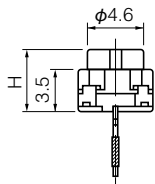
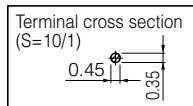
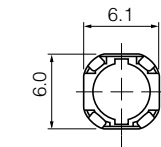

The direction of (a) or (b) side is randomly settled.

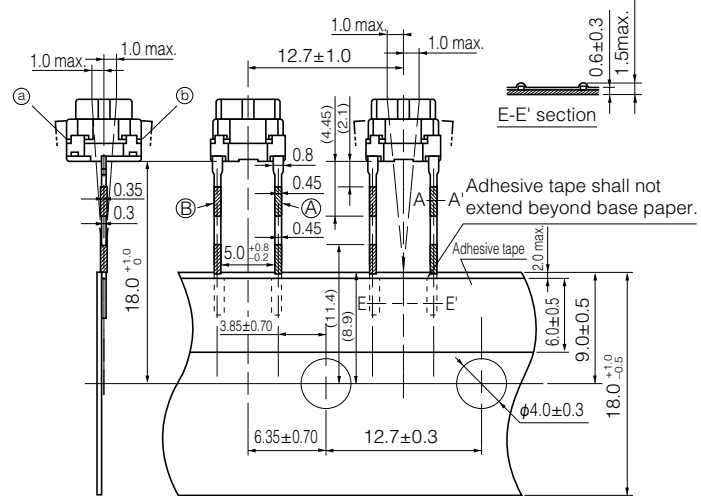

JIS C0806-2 shall be applied for the items not specified here.

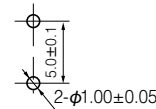

PWB mounting hole for reference
View from mounting side

Part Numbers	Operating Force	Travel	H=Height	Push Plate Color	Operating Life
EVQPVA05K	2.2 N	1.0 mm	5.0 mm	Black	100,000 cycles
EVQPV205K	1.6 N	1.3 mm	5.0 mm	Black	100,000 cycles
EVQPVG05K	2.0 N	1.3 mm	5.0 mm	Black	100,000 cycles
EVQPVF05K	2.5 N	1.3 mm	5.0 mm	Black	100,000 cycles
EVQPVW05K	3.5 N	1.3 mm	5.0 mm	Black	30,000 cycles

Design and specifications are each subject to change without notice. Ask factory for the current technical specifications before purchase and/or use.
Should a safety concern arise regarding this product, please be sure to contact us immediately.

Requests to customers

Please refer to "the latest product specifications" when designing your product.

Requests to customers :

<https://industrial.panasonic.com/ac/e/salespolicies/>

Safety Precautions

When using our products, no matter what sort of equipment they might be used for, be sure to confirm the applications and environmental conditions with our specifications in advance.

Please contact

Panasonic Corporation

Electromechanical Control Business Division

■ 1006, Oaza Kadoma, Kadoma-shi, Osaka 571-8506, Japan
industrial.panasonic.com/ac/e/

Panasonic[®]

©Panasonic Corporation 2019