

PLASTIC PACKAGE INDUSTRIAL GRADE ULTRA MINIATURE PURE SILICON™ CLOCK OSCILLATOR

ASFLMB

Life Size

5.0 x 3.2 x 0.85mm

ASFLMB

RoHS
CompliantMEMS
TECHNOLOGY

FEATURES:

- Ultra Miniature Pure Silicon™ Clock Oscillator
- 2nd Generation MEMS Technology with reduced jitter by Discera
- Low Power Consumption <10mA
- Exceptional Stability +/- 10ppm Over Temp. at -40 to +105°C, +/- 5ppm over -40 to +85°C
- Available in 30kG Shock Resistance Configuration
- Compact QFN Plastic Packaging

APPLICATIONS:

- CCD Clock for VTR Camera
- Equipment Connected to PCs
- Low Profile Equipment
- Computers and Peripherals
- Lower Cost Crystal Oscillator Replacement
- Portable Electronics (MP3 Players, Games)
- Consumer Electronics such as TV's, DVR's, etc.
- Vibrant, Shock-Prone & Humid Environments for Industrial Equipment
- Demanding Military & Automotive Electronics

STANDARD SPECIFICATIONS:

Common Key Electrical Specifications

Parameters	Minimum	Typical	Maximum	Units	Notes
Frequency Range:	1.0	-----	150	MHz	
Operating Temperature:	0	-----	+70	°C	See options
Storage Temperature:	-55	-----	+150	°C	
Overall Frequency Stability*:	-50	-----	+50	ppm	See options
Supply Voltage (Vdd):	+1.8 ~ +3.3			V	
Output Load:	10		15, 25, or 40	pF kΩ	See options
Symmetry:	45		55	%	@1/2Vdd
Startup Time:		1.5	3.0	ms	
Disable Time:		20	100	ns	
Disable Stand-by Current:			15	uA	
Tri-state Function (Stand-by) :	"1" (VIH>0.75*Vdd) or Open: Oscillation "0" (VIL<0.25*Vdd) : Hi Z			V	
Aging:	-5.0	-----	+5.0	ppm	First year

Key Electrical Specifications V_{dd}= 1.8V

Parameters	Minimum	Typical	Maximum	Units	Notes	
Supply Current (no load):	1.0 to 39.9999MHz	-----	5	15	mA	CL=0p RL=∞ T=25°C
	40.0 to 79.9999MHz	-----	6	15	mA	
	80.0 to 124.9999MHz	-----	7	15	mA	
	125.0 to 150MHz	-----	8	15	mA	(Standard CL: 15pF)
	1.0 to 39.9999MHz	-----	6	15	mA	CL=0p RL=∞ T=25°C
	40.0 to 79.9999MHz	-----	7	15	mA	
	80.0 to 124.9999MHz	-----	8	15	mA	
	125.0 to 150MHz	-----	9	15	mA	(CL option: 25pF)
	1.0 to 39.9999MHz	-----	7	15	mA	CL=0p RL=∞ T=25°C
	40.0 to 79.9999MHz	-----	8	15	mA	
	80.0 to 124.9999MHz	-----	9	15	mA	
	125.0 to 150MHz	-----	10	15	mA	(CL option: 40pF)
Output Voltage:	V _{OH}	0.8*V _{dd}	-----	-----	V	
	V _{OL}	-----	-----	0.2*V _{dd}	V	CL=15, 25, 40pF
Rise Time: Fall Time:	Tr	-----	1.8	3.0	ns	CL=15pF; T=25°C
	Tf	-----	1.0	3.0	ns	20%/80%*VDD
	Tr	-----	1.5	3.0	ns	CL=25pF; T=25°C
	Tf	-----	1.2	3.0	ns	20%/80%*VDD
	Tr	-----	1.4	3.0	ns	CL=40pF; T=25°C
	Tf	-----	1.1	3.0	ns	20%/80%*VDD
Cycle to Cycle Jitter:		-----	100	-----	ps	F=100MHz CL=15pF
		-----	55	-----		F=100MHz CL=25pF
		-----	55	-----		F=100MHz CL=40pF
Period Jitter RMS:		-----	12	-----	ps	F=100MHz CL=15pF
		-----	10	-----		F=100MHz CL=25pF
		-----	10	-----		F=100MHz CL=40pF

ABRACON IS
ISO9001:2008
CERTIFIED

Visit www.abracon.com for Terms & Conditions of Sale **Revised: 03.21.12**
30332 Esperanza, Rancho Santa Margarita, California 92688
tel 949-546-8000 | fax 949-546-8001 | www.abracon.com

PLASTIC PACKAGE INDUSTRIAL GRADE ULTRA MINIATURE PURE SILICON™ CLOCK OSCILLATOR

ASFLMB



Life Size



5.0 x 3.2 x 0.85mm

ASFLMB

RoHS
Compliant

Key Electrical Specifications – $V_{dd}=2.5V$

Parameters		Minimum	Typical	Maximum	Units	Notes
Supply Current (no load):	1.0 to 39.9999MHz	-----	6	15	mA	CL=0p
	40.0 to 79.9999MHz	-----	7	15	mA	RL=∞
	80.0 to 124.9999MHz	-----	8	15	mA	T=25°C
	125.0 to 150MHz	-----	9	15	mA	(Standard CL: 15pF)
	1.0 to 39.9999MHz	-----	7	15	mA	CL=0p
	40.0 to 79.9999MHz	-----	8	15	mA	RL=∞
	80.0 to 124.9999MHz	-----	9	15	mA	T=25°C
	125.0 to 150MHz	-----	10	15	mA	(CL option: 25pF)
	1.0 to 39.9999MHz	-----	8	16	mA	CL=0p
	40.0 to 79.9999MHz	-----	9	16	mA	RL=∞
	80.0 to 124.9999MHz	-----	10	16	mA	T=25°C
	125.0 to 150MHz	-----	11	16	mA	(CL option: 40pF)
Output Voltage:	V_{OH}	$0.8 \cdot V_{dd}$	-----	-----	V	CL=15, 25pF
	V_{OL}	-----	-----	$0.2 \cdot V_{dd}$	V	
	V_{OH}	$0.9 \cdot V_{dd}$	-----	-----	V	CL=40pF
	V_{OL}	-----	-----	$0.1 \cdot V_{dd}$	V	
Rise Time: Fall Time:	T_r	-----	1.0	2.0	ns	CL=15pF; T=25°C
	T_f	-----	0.9	2.0	ns	20%/80%*VDD
	T_r	-----	1.1	2.0	ns	CL=25pF; T=25°C
	T_f	-----	0.9	2.0	ns	20%/80%*VDD
	T_r	-----	1.0	2.0	ns	CL=40pF; T=25°C
	T_f	-----	0.9	2.0	ns	20%/80%*VDD
Period Jitter RMS:		-----	6.5	-----	ps	F=100MHz CL=15pF
		-----	5	-----		F=100MHz CL=25pF
		-----	5	-----		F=100MHz CL=40pF
Cycle to Cycle Jitter:		-----	80	-----	ps	F=100MHz CL=15pF
		-----	40	-----		F=100MHz CL=25pF
		-----	40	-----		F=100MHz CL=40pF



PLASTIC PACKAGE INDUSTRIAL GRADE ULTRA MINIATURE PURE SILICON™ CLOCK OSCILLATOR

ASFLMB



ASFLMB

RoHS
Compliant

Life Size



5.0 x 3.2 x 0.85mm

Key Electrical Specifications – $V_{dd}=3.3V$

Parameters		Minimum	Typical	Maximum	Units	Notes	
Supply Current (no load):	1.0 to 39.9999MHz	-----	7	15	mA	CL=0p RL=∞ T=25°C (Standard CL: 15pF)	
	40.0 to 79.9999MHz	-----	8	15	mA		
	80.0 to 124.9999MHz	-----	9	15	mA		
	125.0 to 150MHz	-----	10	15	mA		
	1.0 to 39.9999MHz	-----	8	16	mA	CL=0p RL=∞ T=25°C (CL option: 25pF)	
	40.0 to 79.9999MHz	-----	9	16	mA		
	80.0 to 124.9999MHz	-----	10	16	mA		
	125.0 to 150MHz	-----	11	16	mA		
	Output Voltage:	1.0 to 39.9999MHz	-----	8	16	mA	CL=0p RL=∞ T=25°C (CL option: 40pF)
		40.0 to 79.9999MHz	-----	9	16	mA	
		80.0 to 124.9999MHz	-----	10	16	mA	
		125.0 to 150MHz	-----	11	16	mA	
Output Voltage:	V_{OH}	$0.8*V_{dd}$	-----	-----	V	CL=15pF	
	V_{OL}	-----	-----	$0.2*V_{dd}$	V		
	V_{OH}	$0.9*V_{dd}$	-----	-----	V		
	V_{OL}	-----	-----	$0.1*V_{dd}$	V		
Rise Time: Fall Time:	Tr	-----	1.0	2.0	ns	CL=15pF; T=25°C 20%/80%*VDD	
	Tf	-----	0.9	2.0	ns		
	Tr	-----	1.0	2.0	ns	CL=25pF; T=25°C 20%/80%*VDD	
	Tf	-----	0.9	2.0	ns		
	Tr	-----	0.8	2.0	ns	CL=40pF; T=25°C 20%/80%*VDD	
	Tf	-----	0.8	2.0	ns		
	Period Jitter RMS:		-----	6	-----	ps	F=100MHz CL=15pF
			-----	5	-----		F=100MHz CL=25pF
		-----	5	-----	F=100MHz CL=40pF		
Cycle to Cycle Jitter:		-----	80	-----	ps	F=100MHz CL=15pF	
		-----	40	-----		F=100MHz CL=25pF	
		-----	40	-----		F=100MHz CL=40pF	

Absolute Maximum Ratings

Item	Minimum	Maximum	Unit	Condition
Supply Voltage	-0.3	+4.0	V	
Input Voltage	-0.3	$V_{dd}+0.3$	V	
Junction Temp.	-----	+150	°C	
Storage Temp.	-55	+150	°C	
Soldering Temp.	-----	+260	°C	40sec max
ESD			V	
HBM		4,000		
MM		200		
CDM		1,500		



PLASTIC PACKAGE INDUSTRIAL GRADE ULTRA MINIATURE PURE SILICON™ CLOCK OSCILLATOR

ASFLMB

Life Size

5.0 x 3.2 x 0.85mm

ASFLMB



RoHS
Compliant



OPTIONS AND PART IDENTIFICATION: (Left Blank if Standard)

Programmed Orders (Quantity > 1,000pcs)

ASFLMB - MHz - - -

Frequency in MHz	Operating Temp.	Overall Freq. Stability	Output Load	Packaging
e.g. 14.3181 MHz (Maximum 4 digits after decimal)	Blank: 0°C ~ +70°C E: -20°C ~ +70°C L: -40°C ~ +85°C X: -40°C ~ +105°C	C: ±50ppm (STD) R5*: ±5ppm Y: ±10ppm R: ±25 ppm	Blank: 15pF 25: 25pF 40: 40pF	Blank: 72pcs / Tube T: 1,000pcs / reel T3: 3,000pcs / reel

*R5: ±5ppm stability is available by request. Please contact Abracon for more information.

Un-Programmed Orders

Blank un-programmed oscillators and our low cost portable programmer are available for quick turn engineering requirements. Please call ABRACON or visit MEMSpeed Pro site <http://www.abracon.com/memspeedpro/memspeedpro.html> for more information.

ASFLMB - BLANK - -

Operating Temp.	Overall Freq. Stability	Packaging
Blank: 0°C ~ +70°C E: -20°C ~ +70°C L: -40°C ~ +85°C X: -40°C ~ +105°C	C: ±50ppm (STD) Y: ±10ppm R: ±25 ppm	Blank: 72pcs / Tube T: 1,000pcs / reel T3: 3,000pcs / reel

Note: Available 15pF output load only for ASFLMB blank MEMS oscillator

PLASTIC PACKAGE INDUSTRIAL GRADE ULTRA MINIATURE PURE SILICON™ CLOCK OSCILLATOR

ASFLMB

Life Size

5.0 x 3.2 x 0.85 mm

ASFLMB



RoHS
Compliant

OUTLINE DIMENSIONS:

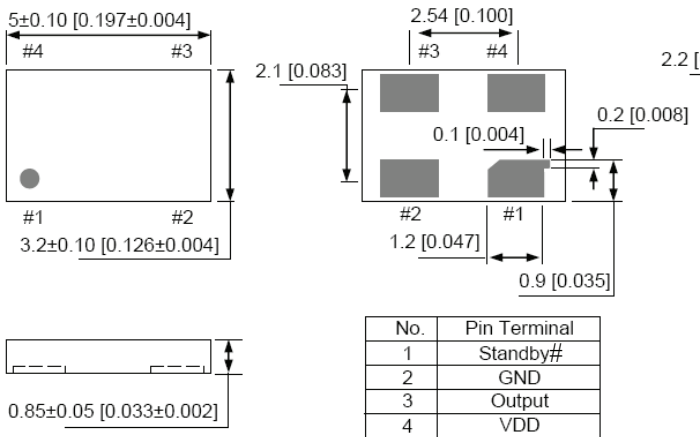

Recommended Land Pattern

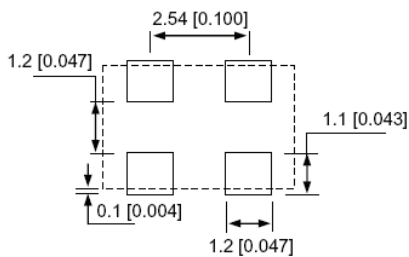

Note: Recommend using an approximately 0.01uF bypass capacitor between PIN 2 and 4.

Dimensions: mm (inches)

TAPE AND REEL:

T= 1,000pcs/reel (D=180mm)

T3= 3,000pcs/reel (D=330mm)

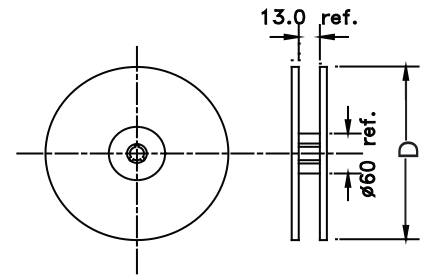
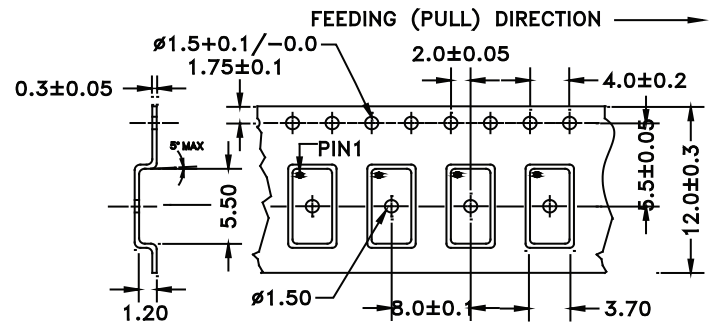
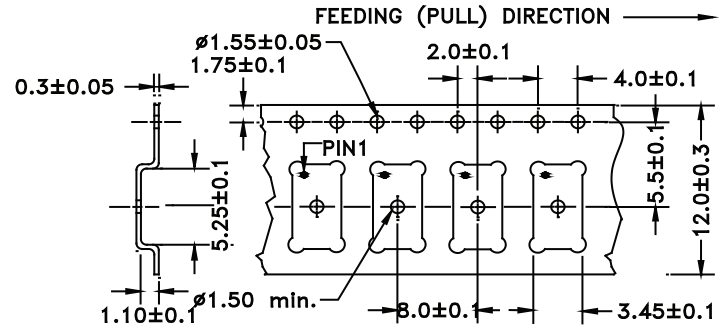

Tube: 72 pcs/tube

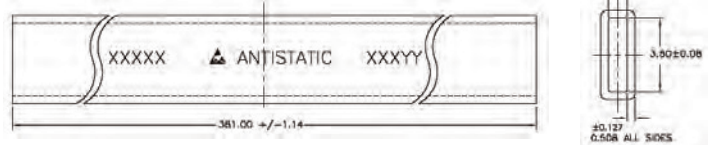

Unit orientation in tube:



Dimensions: mm

REFLOW PROFILE:

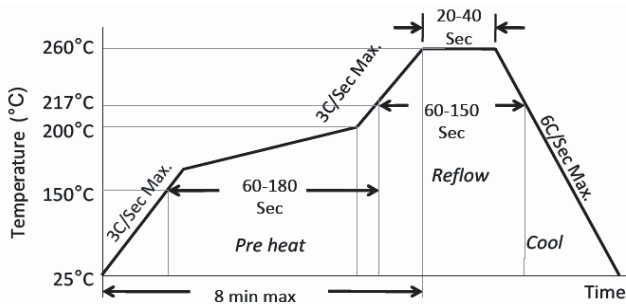

Ramp-Up Rate (200°C to Peak Temp)	3°C/Sec Max.
Preheat Time 150°C to 200°C	60-180 Sec
Time maintained above 217°C	60-150 Sec
Peak Temperature	255-260°C
Time within 5°C of actual Peak	20-40 Sec
Ramp-Down Rate	6°C/Sec Max.
Time 25°C to Peak Temperature	8 min Max.



Need a test socket for the ASFLMB Series? To view compatible **PRECISION TEST SOCKETS** for these parts, [click here](#): PN: **AXS-5032-04-07**.

ATTENTION: Abracon Corporation's products are COTS – Commercial-Off-The-Shelf products; suitable for Commercial, Industrial and, where designated, Automotive Applications. Abracon's products are not specifically designed for Military, Aviation, Aerospace, Life-dependant Medical applications or any application requiring high reliability where component failure could result in loss of life and/or property. For applications requiring high reliability and/or presenting an extreme operating environment, written consent and authorization from Abracon Corporation is required. Please contact Abracon Corporation for more information.

ABRACON IS
ISO9001:2008
CERTIFIED

ABRACON
CORPORATION

Visit www.abracon.com for Terms & Conditions of Sale **Revised: 03.21.12**
30332 Esperanza, Rancho Santa Margarita, California 92688
tel 949-546-8000 | fax 949-546-8001 | www.abracon.com