

# ULTRA PERFORMANCE WIRE-WOUND POWER INDUCTOR

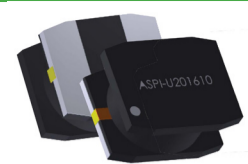

ASPI-U

2.5 x 2.0 x 1.0 mm  
2.0 x 1.6 x 1.0 mm  
MSL = 1

RoHS/RoHS II Compliant

## FEATURES

- Molded wire-wound construction with shielding
- High current up to 6.5A rms typ
- High saturation current up to 11A typ
- High inductance up to 4.7 $\mu$ H
- Low profile 1.0mm MAX for height restricted applications
- Compact 2.0 x 1.6mm footprint
- Wide operating temperature range -40°C ~ +125°C

## APPLICATIONS

- IoT and IIoT
- Industrial and robotics
- Medical monitoring
- Wearables
- Drones
- Energy efficient lighting
- Battery powered applications
- Battery Chargers
- Motor control and motor drivers
- Low to medium power switch mode power supplies

## OPTIONS AND PART IDENTIFICATION

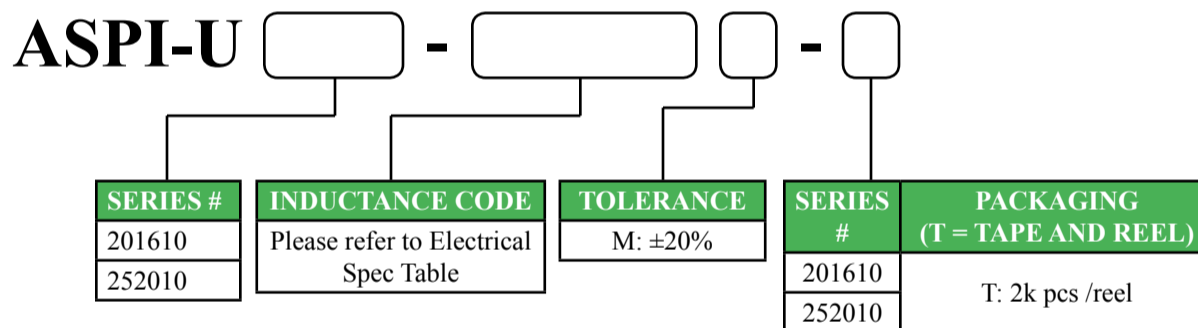

# ULTRA PERFORMANCE WIRE-WOUND POWER INDUCTOR

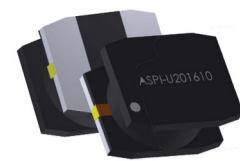

ASPI-U

2.5 x 2.0 x 1.0 mm  
2.0 x 1.6 x 1.0 mm  
MSL = 1

RoHS/RoHS II Compliant

## ELECTRICAL SPECIFICATIONS

OPERATING TEMPERATURE	STORAGE CONDITION
-40°C - 125°C (including self-temperature rise)	-10°C - +40°C and R.H. 70%max

PART NUMBER	INDUCTANCE	TOLERANCE	SEL-RESONANT FREQUENCY	DC RESISTANCE	SATURATION CURRENT		TEMPERATURE RISE CURRENT	
	0.1MHZ/0.1V		min	max	max	typ	max	typ
UNITS	μH	%	mhZ	mΩ	A		A	
SYMBOL	L	M	srf	DCR	Isat		Irms	
ASPI-U201610-R12	0.12	20%	250	15	9.50	11.0	5.60	6.50
ASPI-U201610-R22	0.22	20%	159	22	6.00	6.70	4.50	5.20
ASPI-U201610-R24	0.24	20%	143	22	5.60	6.70	4.50	5.20
ASPI-U201610-R33	0.33	20%	121	25	5.50	6.00	4.10	4.70
ASPI-U201610-R47	0.47	20%	110	33	4.50	5.00	3.60	4.10
ASPI-U201610-R68	0.68	20%	78	45	3.20	3.70	3.10	3.60
ASPI-U201610-1R0	1.0	20%	63	60	3.00	3.50	2.60	3.00
ASPI-U201610-1R5	1.5	20%	50	110	2.80	3.20	2.00	2.30
ASPI-U201610-2R2	2.2	20%	44	120	1.80	2.10	1.90	2.20
ASPI-U201610-4R7	4.7	20%	21	288	1.30	1.50	1.25	1.45
<hr/>								
ASPI-U252010-R12	0.16	20%	214	20	10.0	12.0	5.00	5.80
ASPI-U252010-R24	0.24	20%	149	25	8.50	10.0	4.40	5.10
ASPI-U252010-R33	0.33	20%	117	25	6.00	6.70	4.40	5.10
ASPI-U252010-R47	0.47	20%	92	30	5.30	5.80	4.00	4.60
ASPI-U252010-R68	0.68	20%	67	43	5.20	5.70	3.30	3.80
ASPI-U252010-1R0	1.0	20%	54	50	4.10	4.60	3.10	3.60
ASPI-U252010-1R5	1.5	20%	41	76	3.00	3.40	2.40	2.80
ASPI-U252010-2R2	2.2	20%	34	96	2.60	2.90	2.05	2.40
ASPI-U252010-4R7	4.7	20%	22	240	1.90	2.20	1.40	1.60

**Isat:** DC current at which the inductance drops 30% from its value without current

**Irms:** DC current that causes the temperature rise ( $\Delta T$ , approximate 40°C) from 20°C ambient

## CHARACTERISTICS

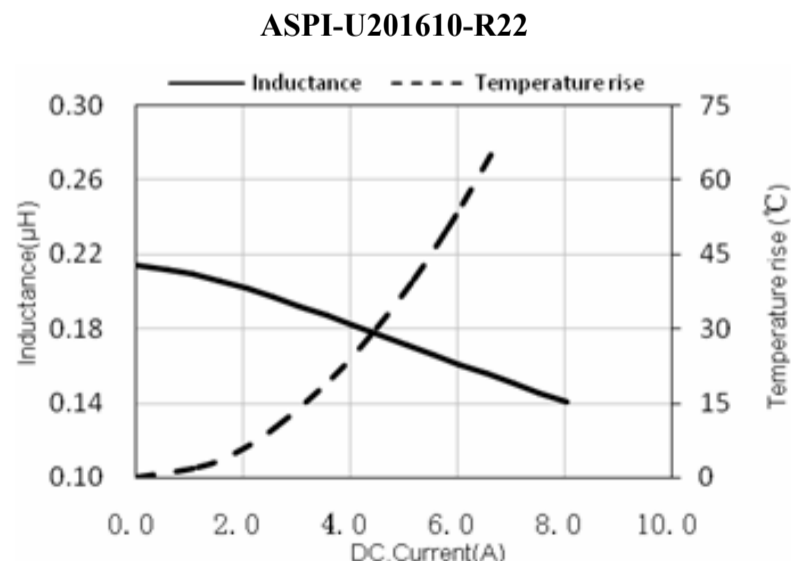
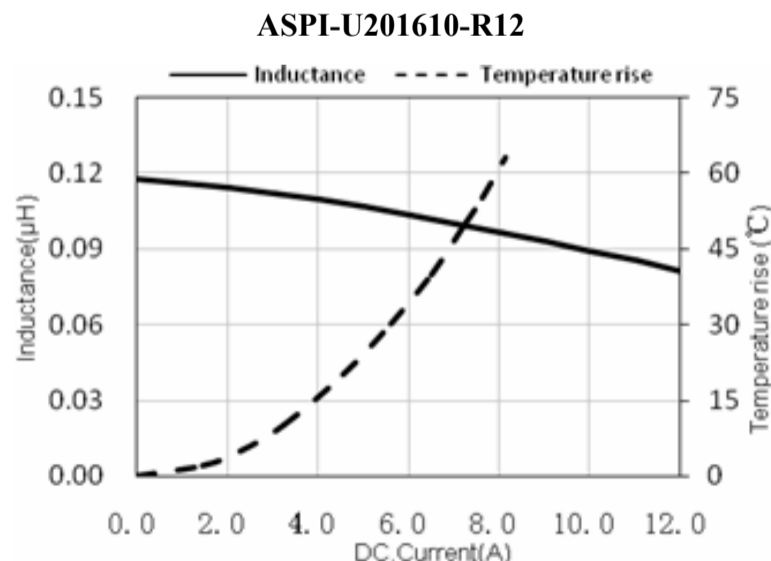

REVISED: 01.29.2019



1501 Hidden Creek Lane Spicewood TX 78751  
Phone: 512-371-6159 | Fax: 512-351-8858  
For terms and conditions of sales visit:  
[www.abracon.com](http://www.abracon.com)

ABRACON IS  
ISO9001-2015  
CERTIFIED

# ULTRA PERFORMANCE WIRE-WOUND POWER INDUCTOR

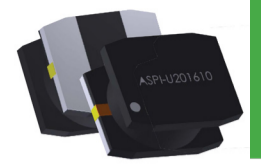

ASPI-U

2.5 x 2.0 x 1.0 mm  
2.0 x 1.6 x 1.0 mm  
MSL = 1

RoHS/RoHS II Compliant

## CHARACTERISTICS

ASPI-U201610-R24

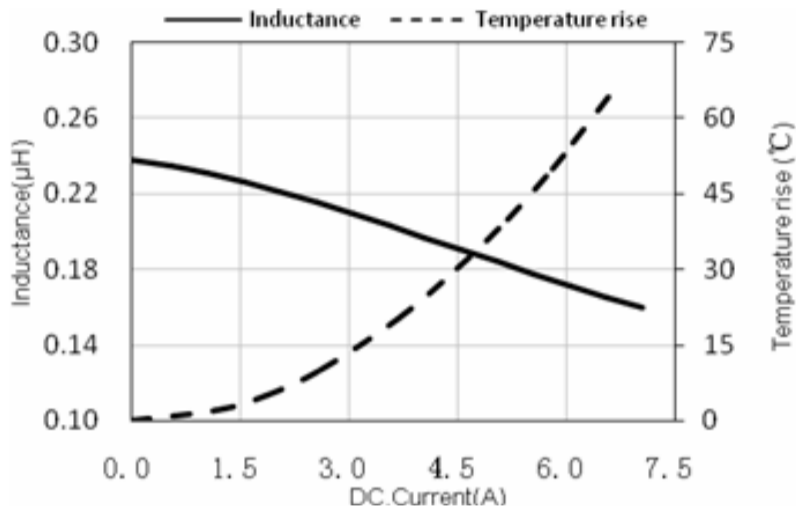

ASPI-U201610-R33

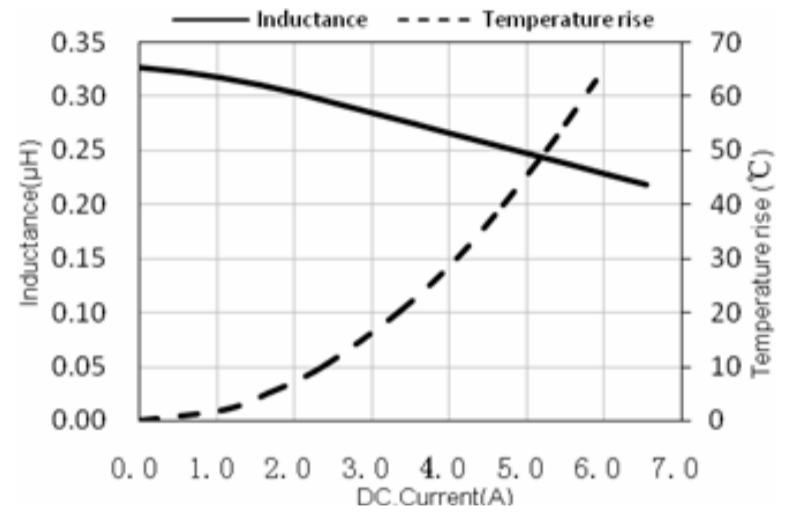

ASPI-U201610-R47

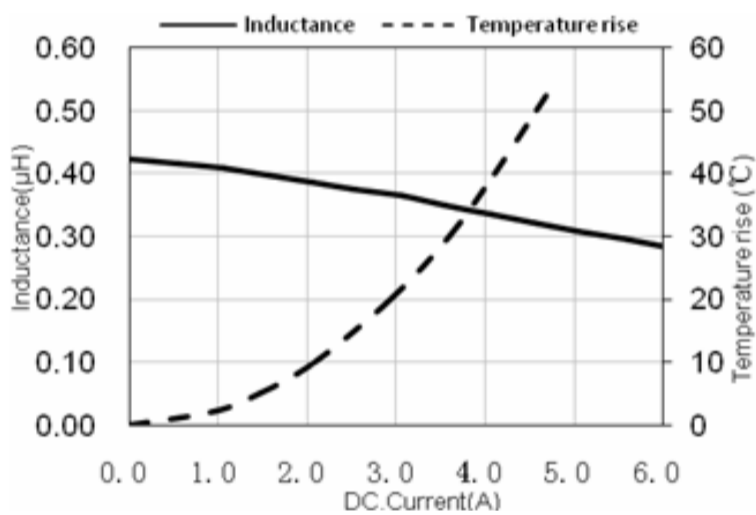

ASPI-U201610-R68

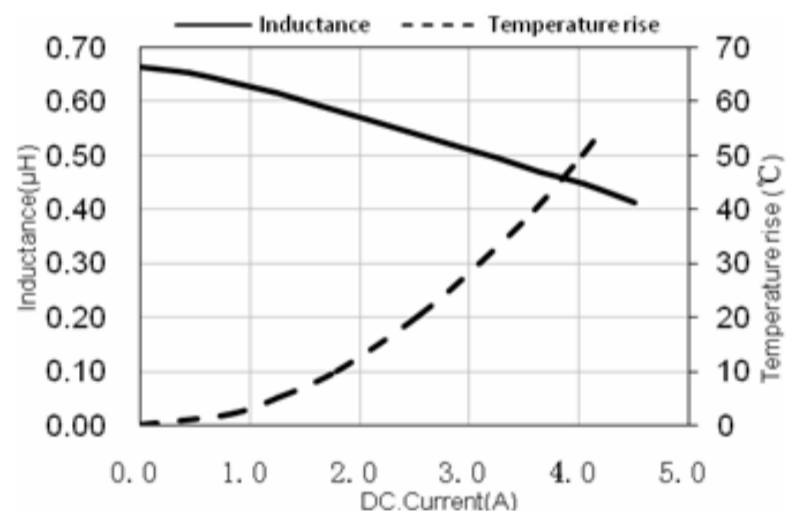

ASPI-U201610-1R0

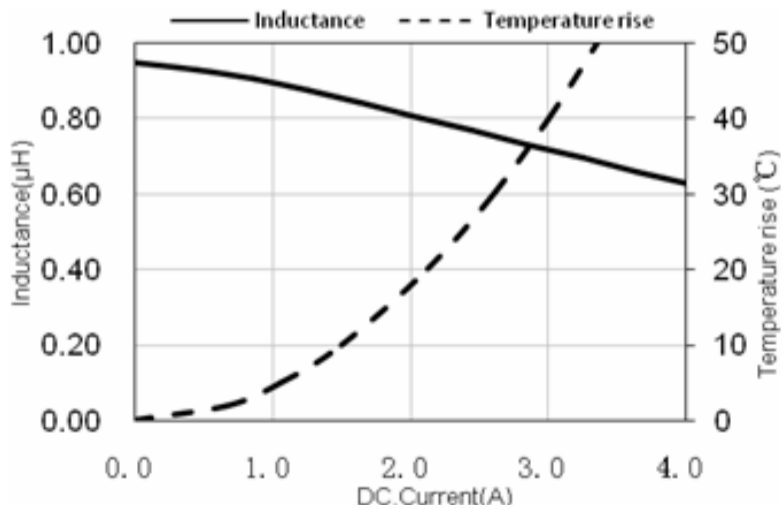

ASPI-U201610-1R5

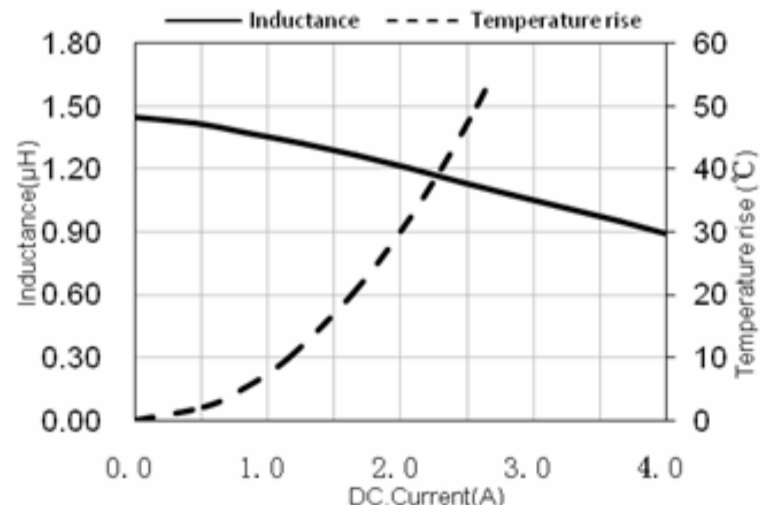

# ULTRA PERFORMANCE WIRE-WOUND POWER INDUCTOR

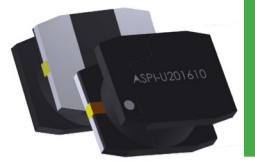

ASPI-U

2.5 x 2.0 x 1.0 mm

2.0 x 1.6 x 1.0 mm

MSL = 1

RoHS/RoHS II Compliant

## CHARACTERISTICS

ASPI-U201610-2R2

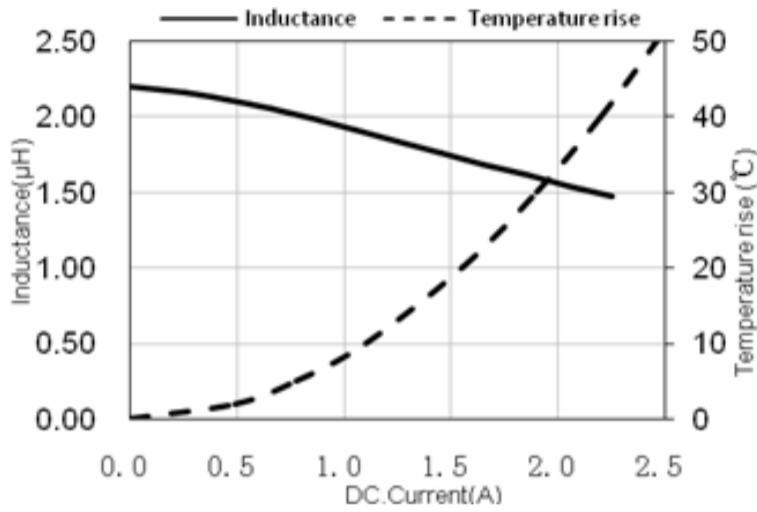

ASPI-U201610-4R7

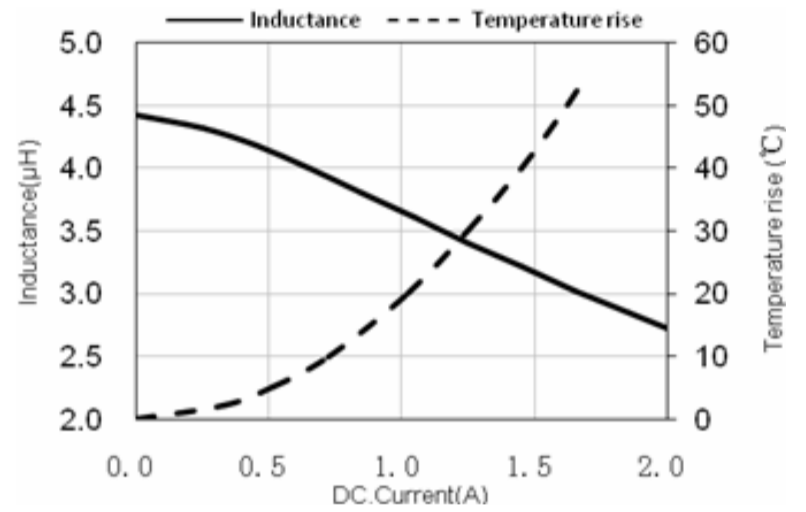

ASPI-U252010-R16

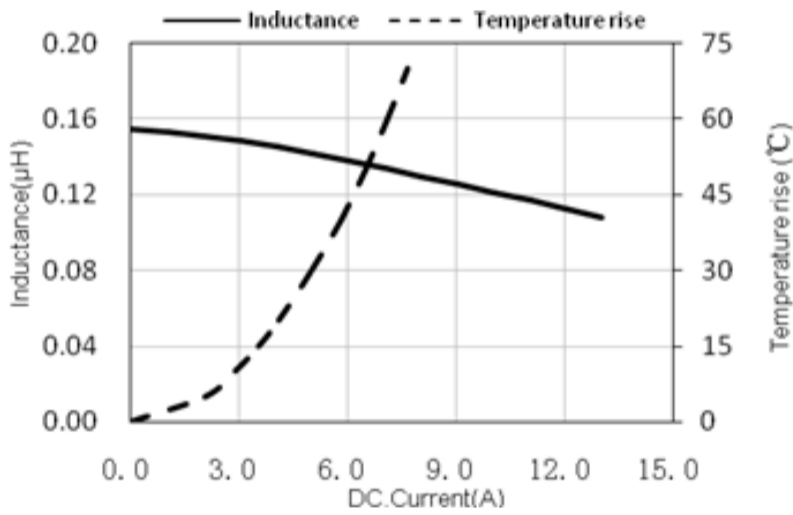

ASPI-U252010-R24

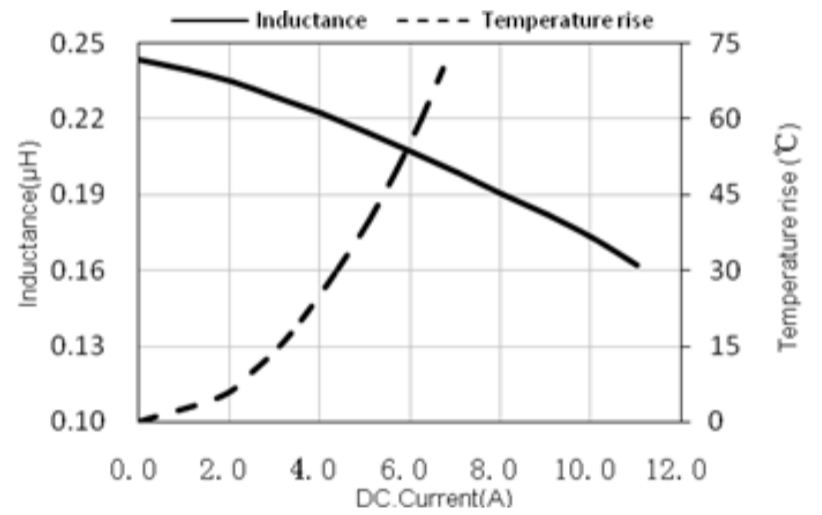

ASPI-U252010-R33

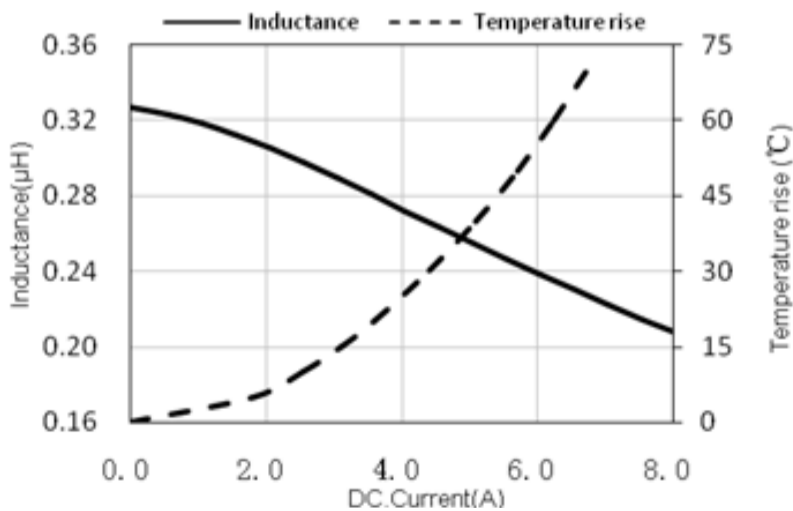

ASPI-U252010-R47

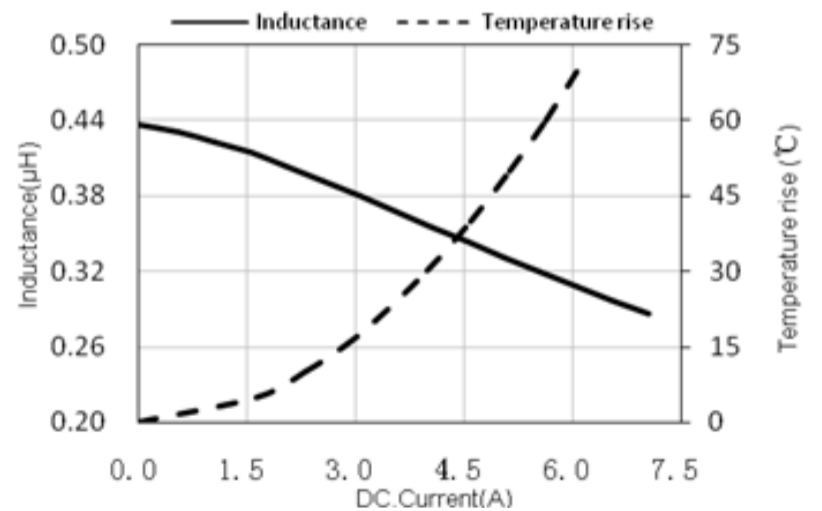

# ULTRA PERFORMANCE WIRE-WOUND POWER INDUCTOR

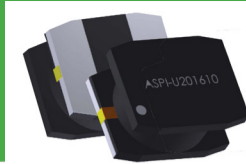

ASPI-U

2.5 x 2.0 x 1.0 mm

2.0 x 1.6 x 1.0 mm

MSL = 1

RoHS/RoHS II Compliant

## CHARACTERISTICS

ASPI-U252010-1R5

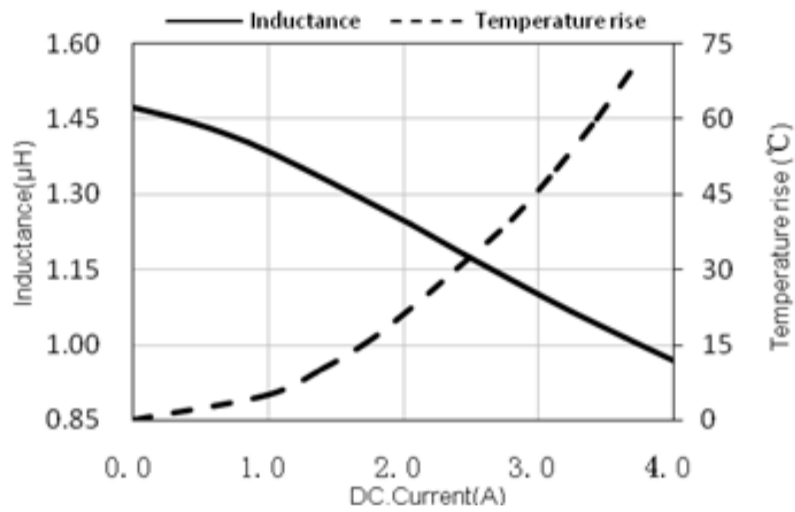

ASPI-U252010-2R2

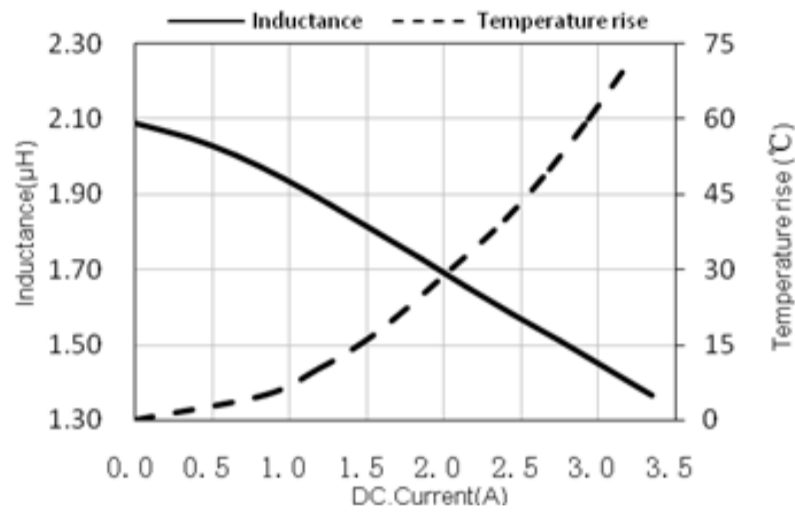

ASPI-U252010-4R7

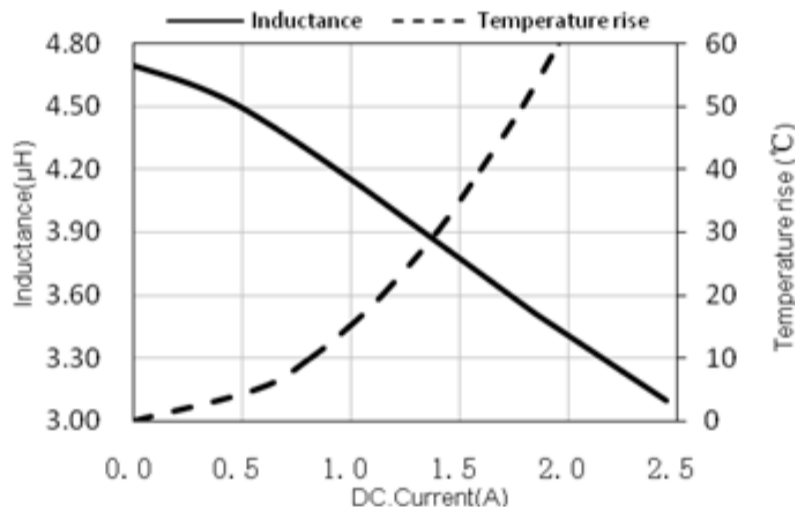

## MECHANICAL DIMENSIONS

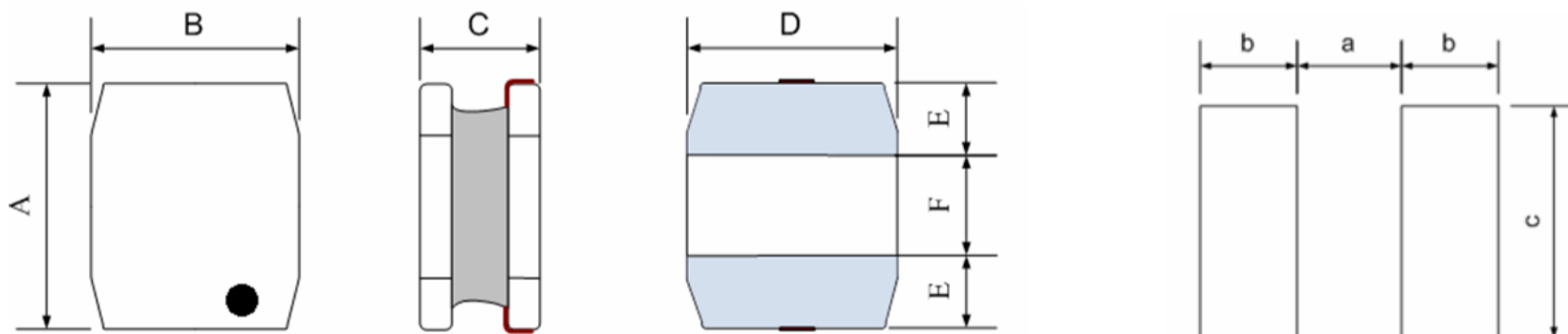

SERIES	A	B	C	D	E	F
ASPI-U201610	2.0 ± 0.2	1.6 ± 0.2	1.0 Max	1.6 ± 0.2	0.6 ± 0.2	0.8 ± 0.2
ASPI-U252010	2.5 ± 0.2	2.0 ± 0.2	1.0 Max	2.0 ± 0.2	0.6 ± 0.2	0.8 ± 0.2

SERIES	A TYP	B TYP	C TYP
ASPI-U201610	0.7	0.7	1.7
ASPI-U252010	1.2	0.8	2.0

Dimensions: mm



1501 Hidden Creek Lane Spicewood TX 78751  
 Phone: 512-371-6159 | Fax: 512-351-8858  
 For terms and conditions of sales visit:  
[www.abracon.com](http://www.abracon.com)

REVISED: 01.29.2019

ABRACON IS  
 ISO9001-2015  
 CERTIFIED

# ULTRA PERFORMANCE WIRE-WOUND POWER INDUCTOR

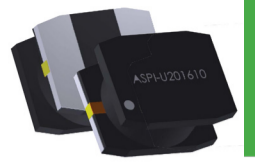

ASPI-U

2.5 x 2.0 x 1.0 mm  
2.0 x 1.6 x 1.0 mm  
MSL = 1

RoHS/RoHS II Compliant

## REFLOW

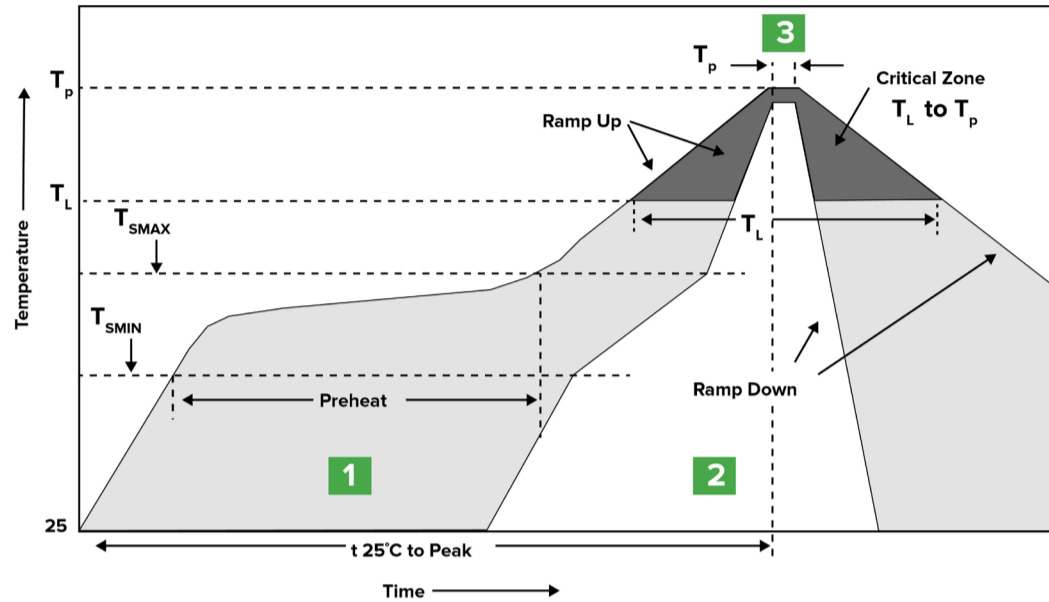

Zone	Description	Temperature	Times
1	Preheat	$T_{SMIN} \sim T_{SMAX}$ 150°C ~ 200°C	60 ~ 120 sec.
2	Reflow	$T_L$ 217°C	60 ~ 90 sec.
3	Peak heat	$T_P$ 260°C	5 sec. MAX

## PACKING (TAPE & REEL: 2000 PCS/REEL)

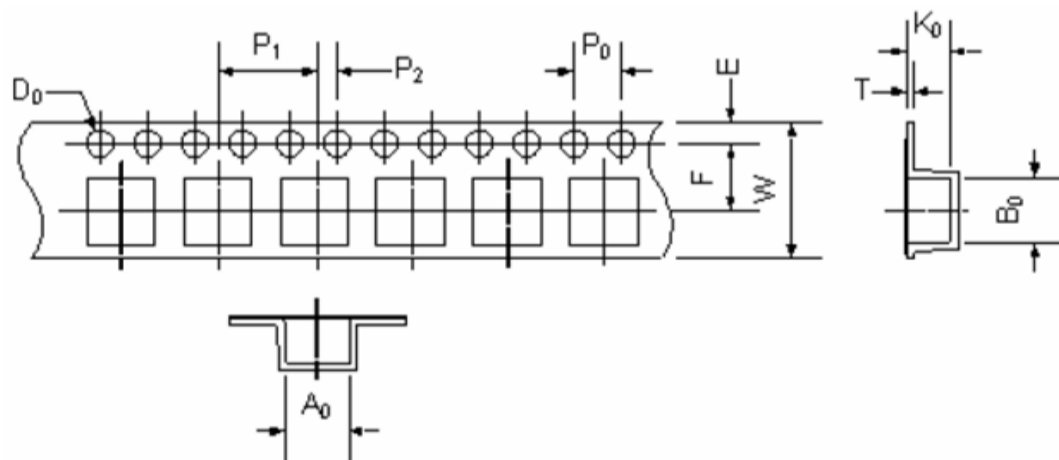

SERIES	W	F	F	P <sub>0</sub>	P <sub>2</sub>	P <sub>3</sub>	D <sub>0</sub>	A <sub>0</sub>	B <sub>0</sub>	T	K <sub>0</sub>
ASPI-U201610	8.0±0.1	1.75±0.1	3.5±0.05	4.0±0.1	4.0±0.1	2.0±0.05	1.5+0.1/-0.0	1.9±0.05	2.2±0.05	0.25±0.02	1.2±0.05
ASPI-U252010	8.0±0.1	1.75±0.1	3.5±0.05	4.0±0.1	4.0±0.1	2.0±0.05	1.5+0.1/-0.0	2.45±0.05	2.75±0.05	0.25±0.03	1.2±0.05

Dimension: mm



1501 Hidden Creek Lane Spicewood TX 78751  
Phone: 512-371-6159 | Fax: 512-351-8858  
For terms and conditions of sales visit:  
[www.abracon.com](http://www.abracon.com)

REVISED: 01.29.2019

ABRACON IS  
ISO9001-2015  
CERTIFIED

# ULTRA PERFORMANCE WIRE-WOUND POWER INDUCTOR

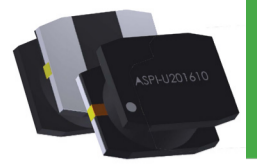

ASPI-U

2.5 x 2.0 x 1.0 mm

2.0 x 1.6 x 1.0 mm

MSL = 1

 RoHS/RoHS II Compliant

## DIRECTION OF ROLLING:

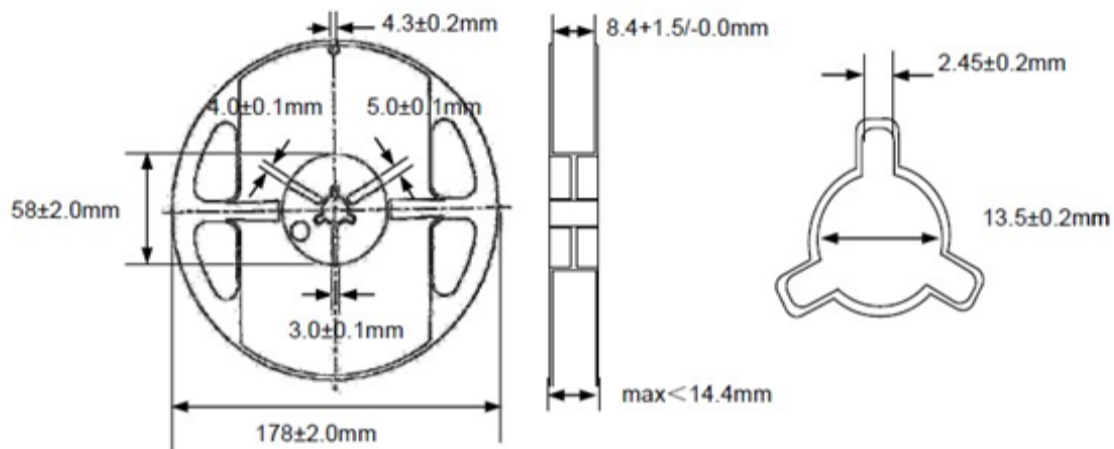
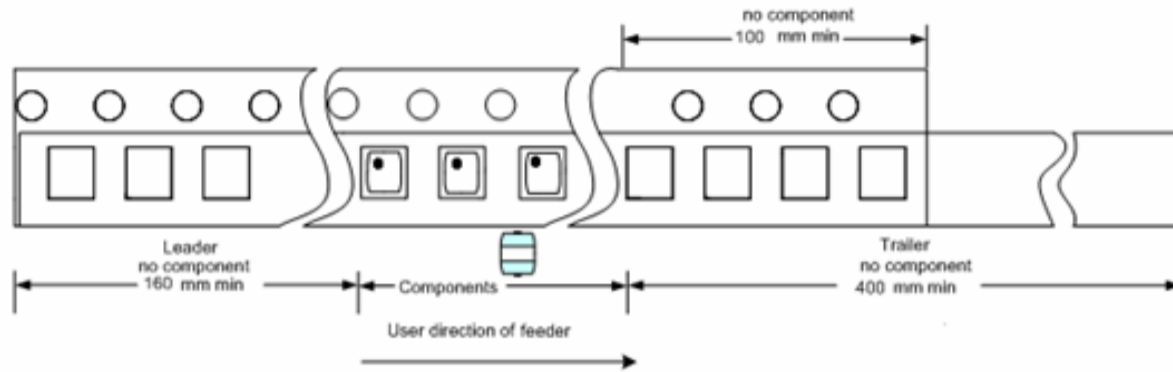

Dimension: mm