

**DIP Switches, Extended Actuator, Auto Insertable, Through Hole and Surface Mount**

**FEATURES:**

- Available in PC or surface mount termination.
- High pressure wiping contact allows aqueous or solvent cleaning without tape seal.
- Auto-insertable
- Tape Seal version available for vacuum pick-n-place
- Unique design can withstand vapor phase reflow or wave soldering conditions.
- Gas tight contacts
- Shipped in the off position

**ENVIRONMENTAL SPECIFICATIONS:**

Operating Temperature .....-30°C to + 85°C  
 Storage Temperature .....-45°C to + 100°C  
 Solder Heat Resistance.....245°C ± 5°C with switch in "off" position 30 seconds when mounted on a .060" thick PCB per MIL-STD202, Method 210  
 Cleaning.....Aqueous solution or solvent

**MATERIAL SPECIFICATIONS:**

Base and Cover .....PPS-UL94V-0, (Black)  
 Actuator.....PA6T-UL94V-0, (White)  
 Fixed Contact/Terminal .....Copper alloy plate-solder/copper  
 Moving Contact .....Copper alloy plate-gold/nickel

**TYPICAL PERFORMANCE CHARACTERISTICS:**

Contact Rating .....0.4 VA @ 20 VDC max.  
 Max Rating Switching-100 Milliamp @ 24VDC  
 Min Rating Switching-1 Microamp @ 1 Millivolt  
 Max Rating Non Switching-1 Amp @ 5VDC  
 Initial Contact Resistance .....50 Milliohms max.  
 Insulation Resistance .....1,000 Megohms min. @ 100 VDC  
 Dielectric Strength .....500 VAC  
 Operating Force .....Less than 800 grams  
 Actuator Travel .....AD/R Series 1.30mm/.050" piano style 25°  
 Life Expectancy .....1,000 Cycles



ADE

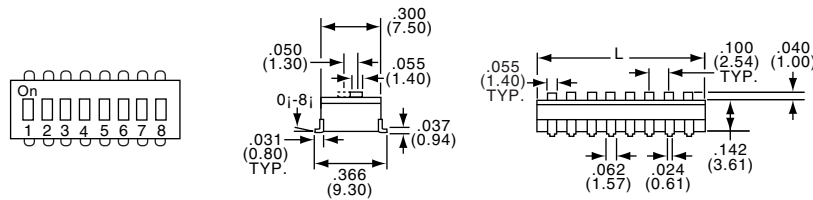

ADE08  
Extended Actuator

S Termination Shown

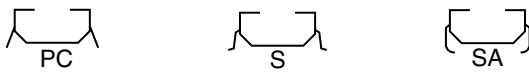

PC Term.		"S" Term.		"SA" Term.		No. of Positions	Actuator Style	Dim. L
Tyco Electronics	Alcoswitch	Tyco Electronics	Alcoswitch	Tyco Electronics	Alcoswitch			
1437586-2	ADE02	1437586-4	ADE02S	1437586-5	ADE02SA	2	Slide	.278(7.06)
1437586-7	ADE03	1437586-8	ADE03S	—	ADE03SA	3	Slide	.378(9.60)
1-1437586-0	ADE04	1-1437586-2	ADE04S	1-1437586-3	ADE04SA	4	Slide	.478(12.14)
1-1437586-5	ADE05	1-1437586-7	ADE05S	—	ADE05SA	5	Slide	.578(14.68)
1-1437586-8	ADE06	2-1437586-0	ADE06S	2-1437586-1	ADE06SA	6	Slide	.678(17.22)
2-1437586-3	ADE07	2-1437586-5	ADE07S	—	ADE07SA	7	Slide	.778(19.76)
2-1437586-6	ADE08	2-1437586-8	ADE08S	2-1437586-9	ADE08SA	8	Slide	.878(22.30)
3-1437586-0	ADE09	—	ADE09S	—	ADE09SA	9	Slide	.978(24.84)
3-1437586-2	ADE10	3-1437586-7	ADE10S	—	ADE10SA	10	Slide	1.078(27.38)
3-1437586-8	ADE12	1571337-1	ADE12S	—	ADE12SA	12	Slide	1.278(32.51)

See Page A9 for PC Pad Layout.

**DIP Switches, Flush Acuator, Auto Insertable, Through Hole, and Surface Mount**

SEE PAGE A7 FOR PRODUCT SPECIFICATIONS

ADF

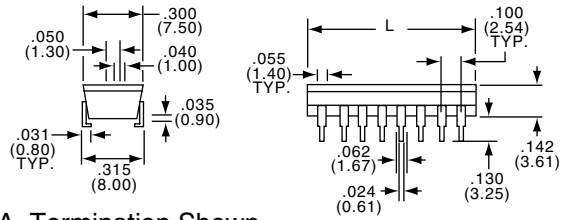
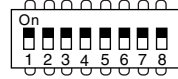

SA Termination Shown

See Page A9 for PC Pad Layout.

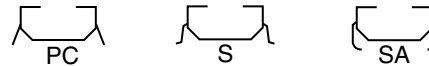

PC Term.		PC Term. w/Tape		No. of Positions	Actuator Style	Dim. L
Tyco Electronics	Alcoswitch	Tyco Electronics	Alcoswitch			
4-1437586-2	ADF02	5-1437586-0	ADF02T	2	Slide	.278(7.06)
5-1437586-1	ADF03	5-1437586-6	ADF03T	3	Slide	.378(9.60)
5-1437586-7	ADF04	6-1437586-4	ADF04T	4	Slide	.478(12.14)
6-1437586-5	ADF05	7-1437586-0	ADF05T	5	Slide	.578(14.68)
7-1437586-1	ADF06	8-1437586-0	ADF06T	6	Slide	.678(17.22)
8-1437586-1	ADF07	8-1437586-5	ADF07T	7	Slide	.778(19.76)
8-1437586-6	ADF08	9-1437586-5	ADF08T	8	Slide	.878(22.30)
9-1437586-6	ADF09	—	ADF09T	9	Slide	.978(24.84)
1437587-1	ADF10	1437587-7	ADF10T	10	Slide	1.078(27.38)
—	ADF12	1571336-1	ADF12T	12	Slide	1.278(32.51)

"S" Term.		"S" Term. w/Tape Seal		Tape & Reel		No. of Positions	Actuator Style	Dim. L
Tyco Electronics	Alcoswitch	Tyco Electronics	Alcoswitch	Tyco Electronics	Alcoswitch			
4-1437586-4	ADF02S	4-1437586-8	ADF02ST	4-1437586-9	ADF02STTR	2	Slide	.278(7.06)
5-1437586-2	ADF03S	5-1437586-4	ADF03ST	5-1437586-5	ADF03STTR	3	Slide	.378(9.60)
5-1437586-9	ADF04S	6-1437586-3	ADF04ST	1437583-6	ADF04STTR	4	Slide	.478(12.14)
6-1437586-6	ADF05S	6-1437586-8	ADF05ST	6-1437586-9	ADF05STTR	5	Slide	.578(14.68)
7-1437586-5	ADF06S	7-1437586-8	ADF06ST	7-1437586-9	ADF06STTR	6	Slide	.678(17.22)
8-1437586-2	ADF07S	8-1437586-3	ADF07ST	8-1437586-4	ADF07STTR	7	Slide	.778(19.76)
8-1437586-8	ADF08S	9-1437586-1	ADF08ST	9-1437586-2	ADF08STTR	8	Slide	.878(22.30)
9-1437586-7	ADF09S	9-1437586-8	ADF09ST	9-1437586-9	ADF09STTR	9	Slide	.978(24.84)
1437587-3	ADF10S	1437587-5	ADF10ST	1437587-6	ADF10STTR	10	Slide	1.078(27.38)
1437587-8	ADF12S	—	ADF12ST	1437587-9	ADF12STTR	12	Slide	1.278(32.51)

"SA" Term.		"SA" Term. w/Tape Seal		No. of Positions	Actuator Style	Dim. L
Tyco Electronics	Alcoswitch	Tyco Electronics	Alcoswitch			
4-1437586-5	ADF02SA	4-1437586-6	ADF02SAT	2	Slide	.278(7.06)
5-1437586-3	ADF03SA	—	ADF03SAT	3	Slide	.378(9.60)
6-1437586-0	ADF04SA	6-1437586-1	ADF04SAT	4	Slide	.478(12.14)
—	ADF05SA	—	ADF05SAT	5	Slide	.578(14.68)
7-1437586-6	ADF06SA	7-1437586-7	ADF06SAT	6	Slide	.678(17.22)
—	ADF07SA	—	ADF07SAT	7	Slide	.778(19.76)
8-1437586-9	ADF08SA	9-1437586-0	ADF08SAT	8	Slide	.878(22.30)
—	ADF09SA	—	ADF09SAT	9	Slide	.978(24.84)
—	ADF10SA	1437587-4	ADF10SAT	10	Slide	1.078(27.38)
—	ADF12SA	—	ADF12SAT	12	Slide	1.278(32.51)

**DIP Switches, Piano Acuator, Auto Insertable, Through Hole, and Surface Mount**

**A**  
AD Series

ADP



ADP04S

Piano Actuator

"PC" Termination Shown

SEE PAGE A7 FOR PRODUCT SPECIFICATIONS

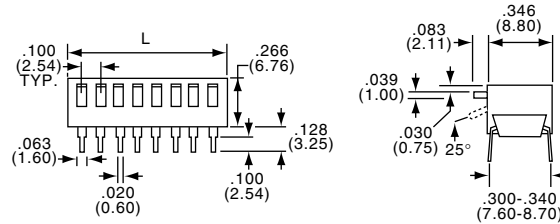

Lever Down "On"		"S" Term Lever Down "On"		"SA" Term. Lever Down "On"		No. of Positions	Actuator Style	Dim. L
Tyco Electronics	Alcoswitch	Tyco Electronics	Alcoswitch	Tyco Electronics	Alcoswitch			
1-1437587-1	ADP02	1-1437587-2	ADP02S	1-1437587-3	ADP02SA	2	Piano	.278(7.06)
1-1437587-5	ADP04	1-1437587-7	ADP04S	1-1437587-8	ADP04SA	4	Piano	.478(12.14)
2-1437587-0	ADP05	2-1437587-1	ADP05S	—	ADP05SA	5	Piano	.578(14.68)
2-1437587-2	ADP06	2-1437587-3	ADP06S	2-1437587-4	ADP06SA	6	Piano	.678(17.22)
2-1437587-5	ADP07	—	ADP07S	—	ADP07SA	7	Piano	.778(19.76)
2-1437587-6	ADP08	2-1437587-8	ADP08S	2-1437587-9	ADP08SA	8	Piano	.878(22.30)
3-1437587-0	ADP09	—	ADP09S	3-1437587-1	ADP09SA	9	Piano	.978(24.84)
3-1437587-3	ADP10	3-1437587-6	ADP10S	—	ADP10SA	10	Piano	1.078(27.38)

Lever Up "On"		"S" Term Lever Up "On"		"SA" Term. Lever Up "On"		No. of Positions	Actuator Style	Dim. L
Tyco Electronics	Alcoswitch	Tyco Electronics	Alcoswitch	Tyco Electronics	Alcoswitch			
4-1437587-7	ADPA02	—	ADPA02S	—	ADPA02SA	2	Piano	.278(7.06)
4-1437587-8	ADPA04	5-1437587-0	ADPA04S	5-1437587-1	ADPA04SA	4	Piano	.478(12.14)
5-1437587-2	ADPA05	5-1437587-3	ADPA05S	—	ADPA05SA	5	Piano	.578(14.68)
5-1437587-4	ADPA06	5-1437587-5	ADPA06S	5-1437587-6	ADPA06SA	6	Piano	.678(17.22)
5-1437587-7	ADPA07	—	ADPA07S	—	ADPA07SA	7	Piano	.778(19.76)
5-1437587-8	ADPA08	6-1437587-0	ADPA08S	—	ADPA08SA	8	Piano	.878(22.30)
—	ADPA09	—	ADPA09S	—	ADPA09SA	9	Piano	.978(24.84)
6-1437587-1	ADPA10	—	ADPA10S	—	ADPA10SA	10	Piano	1.078(27.38)

**TERMINATION OPTIONS**

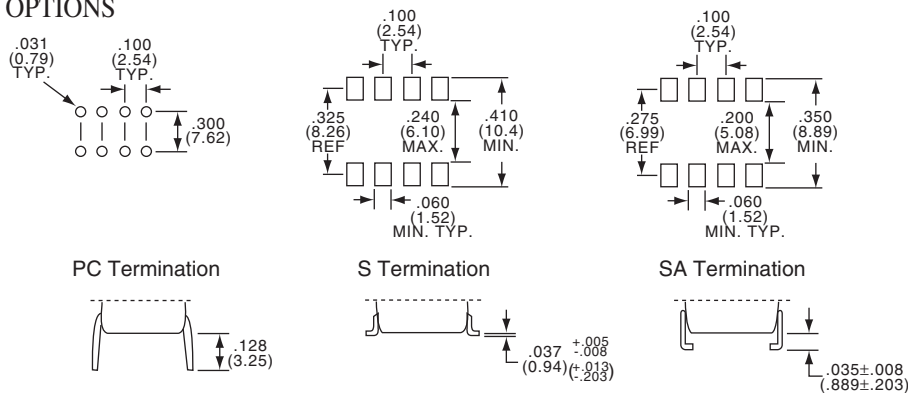

**Hybrid DIP Switches, Through Hole and Surface Mount**

**A**  
AR Series

**AUTO-INSERTABLE\* DIP SWITCH WITH INTEGRAL RESISTORS**

SEE PAGE A7 FOR PRODUCT SPECIFICATIONS

\* Flush actuator versions are auto-insertable

**FEATURES:**

All the features of the AD SERIES - PLUS

- Thick film pull-up resistors molded into the base of the switch.
- Replaces discrete resistor network plus DIP Switch with one component.
- Available with 3.3K ohms or 10K ohms resistors.
- Ceramic substrate allows wave soldering temperatures of 245°C for up to 30 seconds per MIL-STD 202, Method 210.
- Custom resistor values available.
- Shipped in off position.

Rated Pwr.	Resistance	Tolerance	Max. Voltage
125 mW	3.3K Ohms (red)	±5% at 85°C	24V
125 mW	10K Ohms (green)	±5% at 85°C	24V

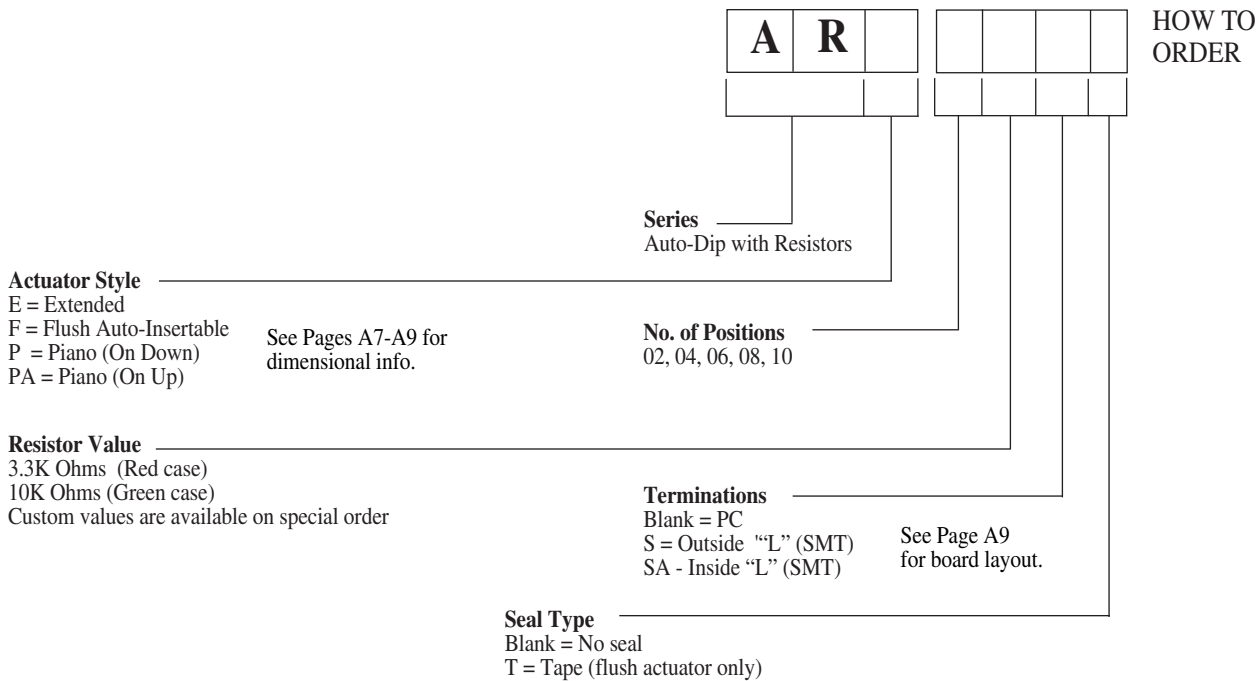
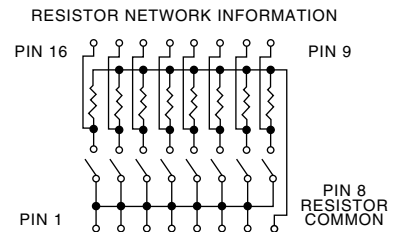

**Example: ARF 06 10KST = Auto-Dip**  
 Flush actuator  
 06 positions  
 10K ohms resistors  
 Outside "L" terminations & tape seal