

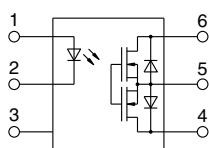

**Normally closed
SOP6-pin type
of 400V load voltage**

**PhotoMOS[®]
GU SOP 1 Form B
(AQV414S)**

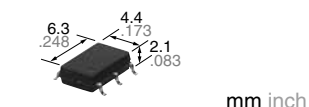

RoHS compliant

FEATURES

1. Miniature SOP6-pin package

The device comes in a small SOP measuring (W) 4.4 × (L) 6.3 × (H) 2.1 mm (W) .173 × (L) .248 × (H) .083 inch approx. 25% of the volume and 50% of the footprint size of DIP type.

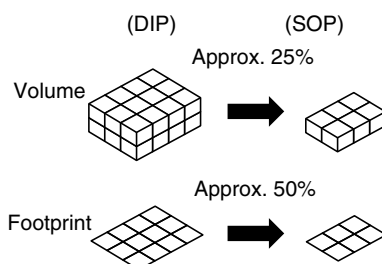

2. Low on-resistance (Typ. 26 Ω) for normally-closed type

This has been achieved thanks to the built-in MOSFET processed by our proprietary method, DSD (Double-Diffused and Selective Doping) method.

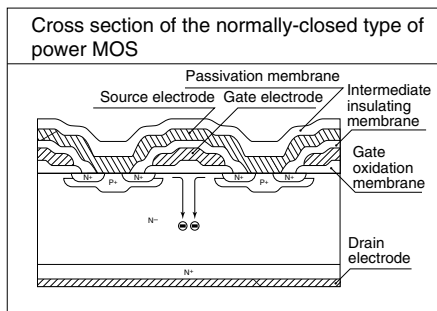

3. Controls low-level analog signals

PhotoMOS feature extremely low closed-circuit offset voltage to enable control of low-level analog signals without distortion.

4. Low-level off state leakage current of max. 1 μA

TYPICAL APPLICATIONS

- Telephones
- Measuring instruments
- Computers
- Industrial robots
- High-speed inspection machines

TYPES

	Output rating*		Package	Part No.			Packing quantity	
	Load voltage	Load current		Tube packing style	Tape and reel packing style		Tube	Tape and reel
					Picked from the 1/2/3-pin side	Picked from the 4/5/6-pin side		
AC/DC dual use	400V	100mA	SOP6-pin	AQV414S	AQV414SX	AQV414SZ	1 tube contains: 75 pcs. 1 batch contains: 1,500 pcs.	1,000 pcs.

* Indicate the peak AC and DC values.

Note: For space reasons, only "V41S" is marked on the product. The two initial letters of the part number "AQ" and the packing style indicator "X" or "Z" have been omitted.

RATING

1. Absolute maximum ratings (Ambient temperature: 25°C 77°F)

Item	Symbol	Type of connection	AQV414S	Remarks	
Input	LED forward current	A	50 mA		
	LED reverse voltage		5 V		
	Peak forward current		1 A	f = 100 Hz, Duty factor = 0.1%	
	Power dissipation		75 mW		
Output	Load voltage (peak AC)	A	400 V		
	Continuous load current		B	0.10 A	A connection: Peak AC, DC B, C connection: DC
			C	0.11 A	
				0.12 A	
	Peak load current			0.3 A	A connection: 100 ms (1 shot) V _L = DC
	Power dissipation			450 mW	
Total power dissipation		500 mW			
I/O isolation voltage			1,500 Vrms		
Ambient temperature	Operating		-40 to +85°C -40 to +185°F	(Non-icing at low temperatures)	
	Storage		-40 to +100°C -40 to +212°F		

2. Electrical characteristics (Ambient temperature: 25°C 77°F)

Item	Symbol	Type of connection	AQV414S	Condition	
Input	LED operate (OFF) current	I _{off}	0.6 mA	I _L = Max.	
			3 mA		
	LED reverse (ON) current	I _{fon}	0.4 mA	I _L = Max.	
			0.55 mA		
LED dropout voltage	V _F	—	1.25 V (1.14 V at I _F = 5 mA)	I _F = 50 mA	
			1.5 V		
Output	On resistance	R _{on}	26 Ω	I _F = 0 mA I _L = Max. Within 1 s	
			50 Ω		
	On resistance	R _{on}	20 Ω	I _F = 0 mA I _L = Max. Within 1 s	
			25 Ω		
	On resistance	R _{on}	10 Ω	I _F = 0 mA I _L = Max. Within 1 s	
			12.5 Ω		
Off state leakage current	I _{Leak}	—	1 μA	I _F = 5 mA, V _L = Max.	
Transfer characteristics	Operate (OFF) time*	T _{off}	0.47 ms	I _F = 0 mA → 5 mA V _L = Max.	
			1.0 ms		
	Reverse (ON) time*	T _{on}	0.28 ms	I _F = 5 mA → 0 mA V _L = Max.	
			1.0 ms		
	I/O capacitance	C _{iso}	—	0.8 pF	f = 1 MHz V _B = 0 V
				1.5 pF	
Initial I/C isolation resistance	R _{iso}	—	1,000 MΩ	500 V DC	

*Operate/Reverse time

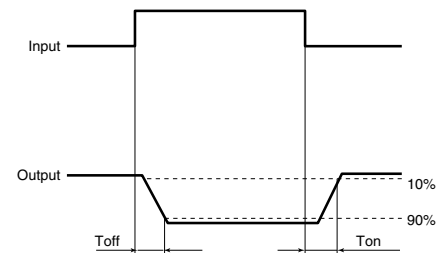

3. Recommended operating conditions (Ambient temperature: 25°C 77°F)

Please use under recommended operating conditions to obtain expected characteristics.

Item	Symbol	Min.	Max.	Unit
LED current	I _F	5	30	mA
Load voltage (Peak AC)	V _L	—	320	V
Continuous load current (A connection)	I _L	—	0.1	A

■ These products are not designed for automotive use.

If you are considering to use these products for automotive applications, please contact your local Panasonic Corporation technical representative.

REFERENCE DATA

1. Load current vs. ambient temperature characteristics

Allowable ambient temperature: -40 to $+85^{\circ}\text{C}$
 -40 to $+185^{\circ}\text{F}$

Type of connection: A

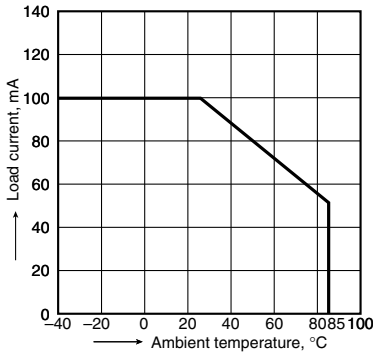

2. On resistance vs. ambient temperature characteristics

Measured portion: between terminals 4 and 6;
 LED current: 0 mA;
 Continuous load current: 100 mA (DC)

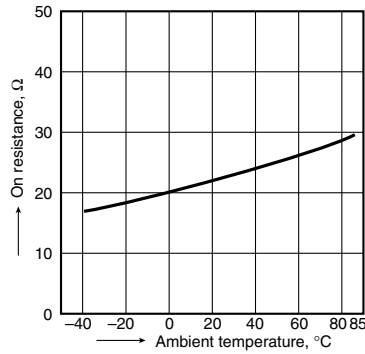

3. Operate (OFF) time vs. ambient temperature characteristics

LED current: 5 mA;
 Load voltage: 400 V (DC);
 Continuous load current: 100 mA (DC)

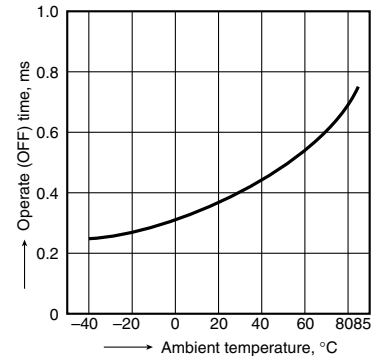

4. Reverse (ON) time vs. ambient temperature characteristics

LED current: 50 mA;
 Load voltage: 400 V (DC);
 Continuous load current: 100 mA (DC)

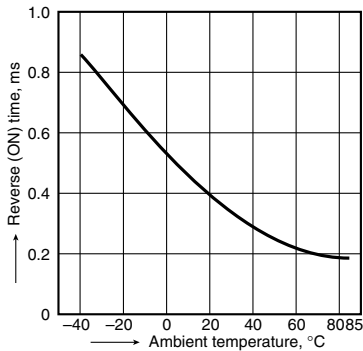

5. LED operate (OFF) current vs. ambient temperature characteristics

Load voltage: 400 V (DC);
 Continuous load current: 100 mA (DC)

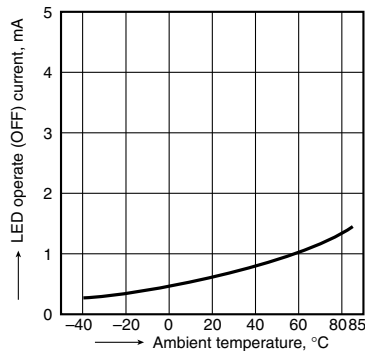

6. LED reverse (ON) current vs. ambient temperature characteristics

Load voltage: 400 V (DC);
 Continuous load current: 100 mA (DC)

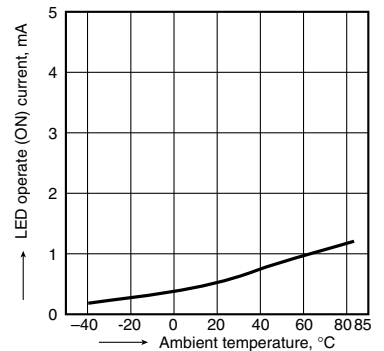

7. LED dropout voltage vs. ambient temperature characteristics

LED current: 5 to 50 mA

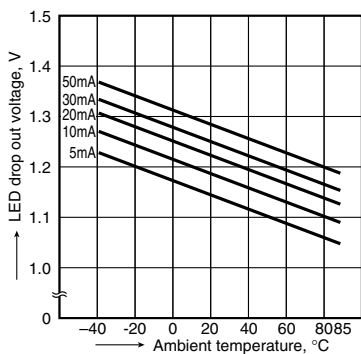

8. Current vs. voltage characteristics of output at MOS portion

Measured portion: between terminals 4 and 6;
 Ambient temperature: 25°C 77°F

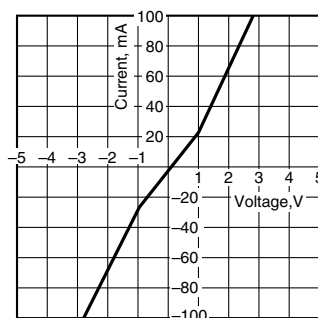

9. Off state leakage current vs. load voltage characteristics

Measured portion: between terminals 4 and 6;
 LED current: 5 mA;
 Ambient temperature: 25°C 77°F

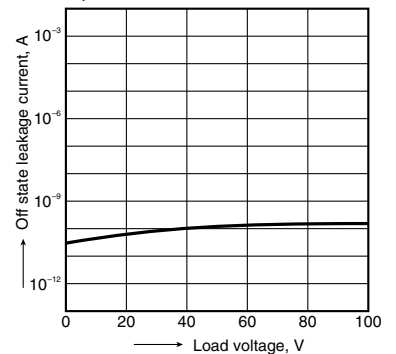

10. Operate (OFF) time vs. LED forward current characteristics

Measured portion: between terminals 4 and 6;
 Load voltage: 400 V (DC); Continuous load current:
 100 mA (DC); Ambient temperature: 25°C 77°F

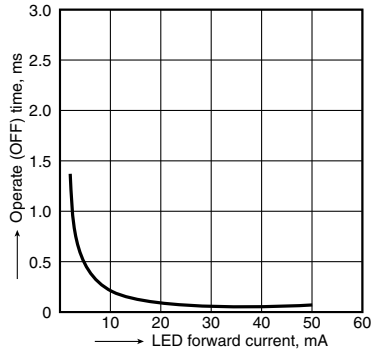

11. Reverse (ON) time vs. LED forward current characteristics

Measured portion: between terminals 4 and 6;
 Load voltage: 400 V (DC); Continuous load current:
 100 mA (DC); Ambient temperature: 25°C 77°F

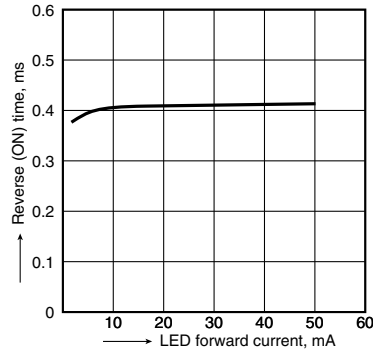

12. Output capacitance vs. applied voltage characteristics

Measured portion: between terminals 4 and 6;
 LED current: 5 mA; Frequency: 1 MHz;
 Ambient temperature: 25°C 77°F

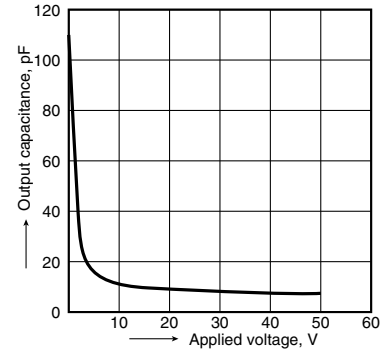

"PhotoMOS®", "PhotoMOS" and "PHOTOMOS" are registered trademarks of Panasonic Corporation.

*Recognized in Japan, the United States, all member states of European Union and other countries.

Please contact

Panasonic Corporation

Electromechanical Control Business Division

■ 1006, Oaza Kadoma, Kadoma-shi, Osaka 571-8506, Japan
industrial.panasonic.com/ac/e/

Panasonic®

©Panasonic Corporation 2017