



**2c 15A, 4c 10A polarized  
power relays**

## SP RELAYS



**RoHS compliant**

Protective construction: Dust cover type

### FEATURES

**1. Small, slim form factor**

Facilitating the form factor reduction of devices, the overall height of the relay package is less than half that of our HP relay.

**2. High sensitivity**

The high-efficiency polarized electromagnetic mechanism in conjunction with our exclusive spring alignment method achieves levels of sensitivity higher than relays that have been available up to now. For both the 2 Form C and 4 Form C single side stable and 2 coil latching types, the 150 mW minimum operating power level allows direct driving by transistor or chip controllers.

**3. High reliability and long life**

With a structure that ensures almost perfectly complete twin contact and minimal contact bounce, you get greater reliability than has so far been provided by power relays.

**4. Latching types also available**

1 coil latching and 2 coil latching types are available. In cases where it was formerly unavoidable to use plural relays for large power memory, you can now use a single SP relay.

**5. Strong resistance to vibration and shock**

Our balanced armature technology well withstands vibration and shocks. It provides strong resistance to vibration and shock.

**6. Terminals and mounting boards are available**

### TYPICAL APPLICATIONS

**1. Electrical power device**

**2. Robots**

**3. Railway signal equipment**

**ORDERING INFORMATION**

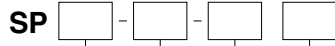

Contact arrangement  
2: 2 Form C  
4: 4 Form C

Terminal shape  
Nil: Plug-in type  
P: PC board type

Operating function  
Nil: Single side stable  
L: 1 coil latching  
L2: 2 coil latching

Nominal coil voltage  
3, 5, 6, 12, 24, 48 V DC

Notes: 1. PC board type and 1 coil latching type are manufactured by lot upon receipt of order.  
2. Certified by UL, CSA and TÜV

**TYPES**

Contact arrangement	Nominal coil voltage	Single side stable	2 coil latching
		Part No.	Part No.
2 Form C	3V DC	SP2-DC3V	SP2-L2-DC3V
	5V DC	SP2-DC5V	SP2-L2-DC5V
	6V DC	SP2-DC6V	SP2-L2-DC6V
	12V DC	SP2-DC12V	SP2-L2-DC12V
	24V DC	SP2-DC24V	SP2-L2-DC24V
	48V DC	SP2-DC48V	SP2-L2-DC48V
4 Form C	3V DC	SP4-DC3V	SP4-L2-DC3V
	5V DC	SP4-DC5V	SP4-L2-DC5V
	6V DC	SP4-DC6V	SP4-L2-DC6V
	12V DC	SP4-DC12V	SP4-L2-DC12V
	24V DC	SP4-DC24V	SP4-L2-DC24V
	48V DC	SP4-DC48V	SP4-L2-DC48V

Standard packing (2 Form C): Carton: 20 pcs.; Case: 200 pcs.  
Standard packing (4 Form C): Carton: 10 pcs.; Case: 100 pcs.  
Note: PC board type and 1 coil latching type are manufactured by lot upon receipt of order.  
\* Terminal sockets and mounting boards available.

**RATING**

**1. Coil data**

1) Single side stable

Nominal coil voltage	Pick-up voltage (at 20°C 68°F)	Drop-out voltage (at 20°C 68°F)	Nominal operating current [±10%] (at 20°C 68°F)	Coil resistance [±10%] (at 20°C 68°F)	Nominal operating power	Max. applied voltage
3V DC	70%V or less of nominal voltage (Initial)	10%V or more of nominal voltage (Initial)	100mA	30Ω	300mW	150%V of nominal voltage
5V DC			60.2mA	83Ω		
6V DC			50mA	120Ω		
12V DC			25mA	480Ω		
24V DC			12.5mA	1,920Ω		
48V DC			6.2mA	7,700Ω		

2) 2 coil latching

Nominal coil voltage	Set voltage (at 20°C 68°F)	Reset voltage (at 20°C 68°F)	Nominal operating current [±10%] (at 20°C 68°F)		Coil resistance [±10%] (at 20°C 68°F)		Nominal operating power		Max. applied voltage
			Set coil	Reset coil	Set coil	Reset coil	Set coil	Reset coil	
3V DC	70%V or less of nominal voltage (Initial)	70%V or less of nominal voltage (Initial)	100mA	100mA	30Ω	30Ω	300mW	300mW	150%V of nominal voltage
5V DC			60.2mA	60.2mA	83Ω	83Ω			
6V DC			50mA	50mA	120Ω	120Ω			
12V DC			25mA	25mA	480Ω	480Ω			
24V DC			12.5mA	12.5mA	1,920Ω	1,920Ω			
48V DC			6.2mA	6.2mA	7,680Ω	7,680Ω			

## 2. Specifications

Characteristics	Item	Specifications	
Contact	Initial contact pressure	2 Form C: Approx. 0.392 N (40 g 1.41 oz), 4 Form C: Approx. 0.196 N (20 g 0.71 oz)	
	Arrangement	2 Form C, 4 Form C	
	Contact resistance (Initial)	Max. 30 mΩ (By voltage drop 6 V DC 1A)	
	Contact material	Stationary contact: Au flashed AgSnO <sub>2</sub> type, Movable contact: AgSnO <sub>2</sub> type	
Rating	Nominal switching capacity (resistive load)	2 Form C: 15 A 250 V AC, 4 Form C: 10 A 250 V AC	
	Max. switching power (resistive load)	2 Form C: 3,750 VA, 300 W, 4 Form C: 2,500 VA, 300 W	
	Max. switching voltage	2 Form C, 4 Form C: 250 V AC, 30 V DC (48V DC: Max. 2A)	
	Max. switching current	2 Form C: 15 A (AC) 10 A (DC), 4 Form C: 10 A	
	Nominal operating power	300mW (Single side stable, 2 coil latching)	
	Min. switching capacity (reference value)*1	100 mA 5V DC	
Electrical characteristics	Insulation resistance (Initial) (25°C, 50% relative humidity)	Min. 1,000MΩ (at 500V DC) Measurement at same location as "Breakdown voltage" section.	
	Breakdown voltage (Initial)	Between open contacts	1,500 Vrms for 1 min. (Detection current: 10 mA)
		Between contact and coil	3,000 Vrms for 1 min. (Detection current: 10 mA)
		Between contact sets	3,000 Vrms for 1 min. (Detection current: 10 mA)
	Operate time [Set time] (at 20°C 68°F) (Initial)	Max. 30 ms [Max. 30 ms] (Nominal coil voltage applied to the coil, excluding contact bounce time.)	
	Release time [Reset time] (at 20°C 68°F) (Initial)	Max. 20 ms [Max. 30 ms] (Nominal coil voltage applied to the coil, excluding contact bounce time.) (without diode)	
Mechanical characteristics	Shock resistance	Functional	Min. 392 m/s <sup>2</sup> (Half-wave pulse of sine wave: 11 ms; detection time: 10μs.)
		Destructive	Min. 980 m/s <sup>2</sup> (Half-wave pulse of sine wave: 6 ms.)
	Vibration resistance	Functional	10 to 55 Hz at double amplitude of 3 mm (Detection time: 10μs.)
		Destructive	10 to 55 Hz at double amplitude of 3 mm
Expected life	Mechanical	Min. 5×10 <sup>7</sup> (at 180 times/min.)	
	Electrical (resistive load)	2 Form C: Min. 10 <sup>5</sup> (15 A 250 V AC [at 20 times/min.]), Min. 10 <sup>5</sup> (10 A 30 V DC [at 20 times/min.]) 4 Form C: Min. 10 <sup>5</sup> (15 A 250 V AC [at 20 times/min.]), Min. 10 <sup>5</sup> (10 A 30 V DC [at 20 times/min.])	
Conditions	Conditions for operation, transport and storage*2	Ambient temperature: -50°C to +60°C -58°F to +140°F; Humidity: 5 to 85% R.H. (Not freezing and condensing at low temperature)	
	Max. operating speed	20 times/min. (at rated load)	
Unit weight		2 Form C: 50 g 1.76 oz; 4 Form C: 65 g 2.29 oz	

Notes: \*1. This value can change due to the switching frequency, environmental conditions, and desired reliability level, therefore it is recommended to check this with the actual load.

\*2. The upper limit of the ambient temperature is the maximum temperature that can satisfy the coil temperature rise value. Refer to Usage, transport and storage conditions in NOTES.

## REFERENCE DATA

### 1.-(1) Coil temperature rise (2 Form C type)

Tested sample: SP2-DC24V

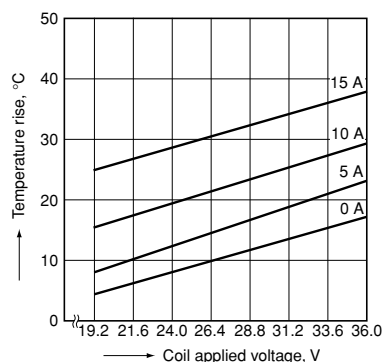

### 1.-(2) Coil temperature rise (4 Form C type)

Tested sample: SP4-DC24V

Ambient temperature: 27 to 29°C 81 to 84°F

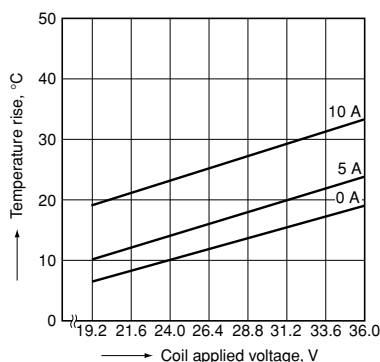

2. Electrical life (SP2, 15 A 250 V AC resistive load)

Change of pick-up and drop-out voltage

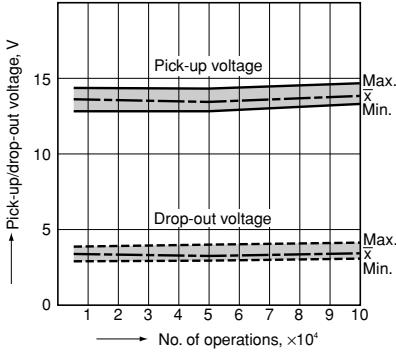

Change of contact resistance

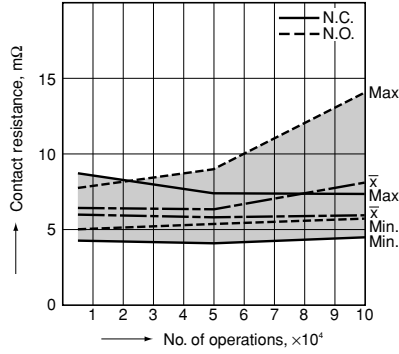

3. Electrical life (SP4, 10 A 250 V AC resistive load)

Change of pick-up and drop-out voltage

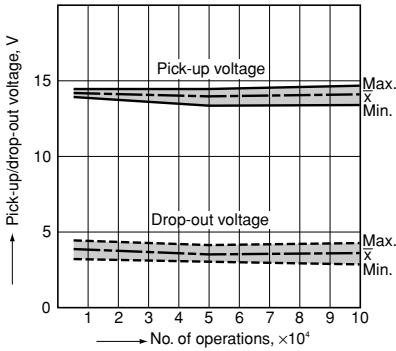

Change of contact resistance

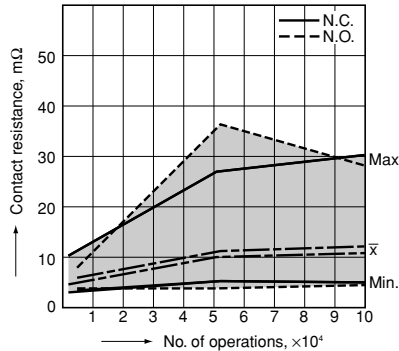

**DIMENSIONS** (mm inch)

The CAD data of the products with a **CAD Data** mark can be downloaded from: <http://industrial.panasonic.com/ac/e/>

**2 Form C**

1) Plug-in terminal

**CAD Data** External dimensions

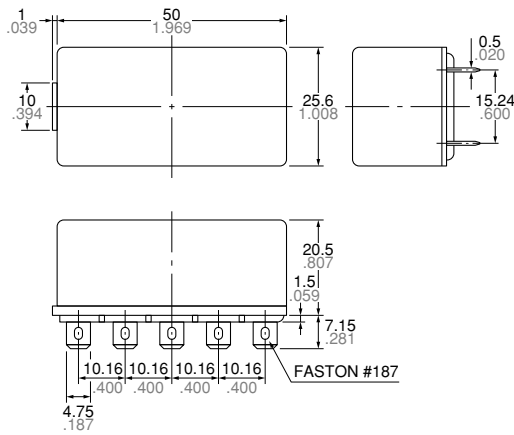

General tolerance:  $\pm 0.3 \pm 0.12$

2) PC board type

**CAD Data** External dimensions

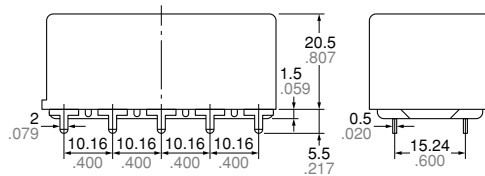

General tolerance:  $\pm 0.3 \pm 0.12$

PC board pattern (Bottom view)

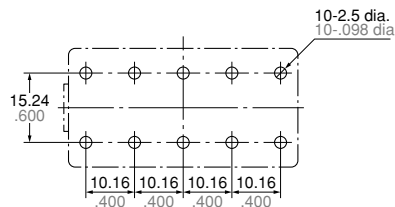

Tolerance:  $\pm 0.1 \pm 0.04$

Schematic (Bottom view)

Single side stable type

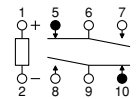

(Deenergized condition)

2 coil latching type

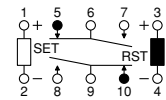

(Reset condition)

Diagram shows the "reset" position when terminals 3 and 4 are energized. Energize terminals 1 and 2 to transfer contacts.

**4 Form C**

1) Plug-in terminal

**CAD Data** External dimensions

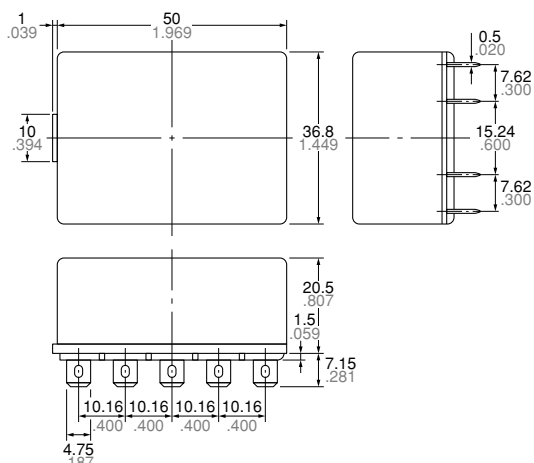

General tolerance:  $\pm 0.3 \pm 0.12$

2) PC board type

**CAD Data** External dimensions

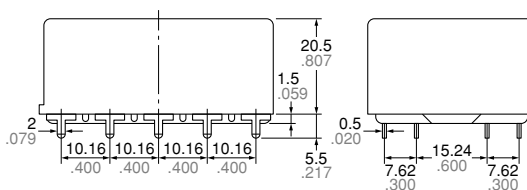

General tolerance:  $\pm 0.3 \pm 0.12$

PC board pattern (Bottom view)

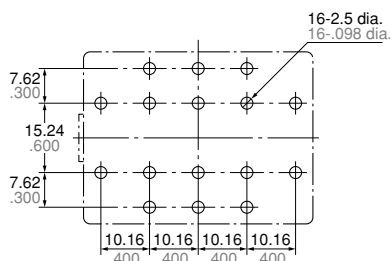

Tolerance:  $\pm 0.1 \pm 0.004$

Schematic (Bottom view)

Single side stable type

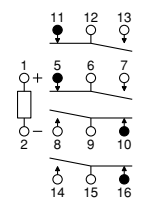

(Deenergized condition)

2 coil latching type

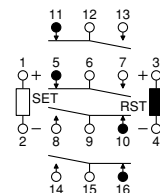

(Reset condition)

Diagram shows the "reset" position when terminals 3 and 4 are energized. Energize terminals 1 and 2 to transfer contacts.

**SAFETY STANDARDS**

Item	UL (Recognized)		CSA (Certified)		TÜV (Certified)		
	File No.	Contact rating	File No.	Contact rating	File No.	Contact rating	Cycles
2 Form C	E43028	15A 250V AC General Use	LR26550	15A 250V AC General Use	B 11 08 13461 308	15A 250V AC ( $\cos\phi=1.0$ )	10 <sup>5</sup>
		1/2HP 125, 250V AC		1/2HP 125, 250V AC		10A 30V DC (0ms)	10 <sup>5</sup>
		10A 30V DC		10A 30V DC		—	—
4 Form C	E43028	10A 250V AC General Use	LR26550	10A 250V AC General Use	B 11 08 13461 308	10A 250V AC ( $\cos\phi=1.0$ )	10 <sup>5</sup>
		1/2HP 125, 250V AC		1/2HP 125, 250V AC		10A 30V DC (0ms)	10 <sup>5</sup>
		10A 30V DC		10A 30V DC		—	—

**NOTES**

1. For cautions for use, please read "GENERAL APPLICATION GUIDELINES".

---

Please contact .....

**Panasonic Corporation**

Electromechanical Control Business Division

■ 1006, Oaza Kadoma, Kadoma-shi, Osaka 571-8506, Japan  
[industrial.panasonic.com/ac/e/](http://industrial.panasonic.com/ac/e/)

**Panasonic**<sup>®</sup>

©Panasonic Corporation 2016