

New!

AV SERIES SECURITY PUSHBUTTON SWITCHES

SPECIFICATIONS	FEATURES
<p>Contact ratings: 2 A at 48 VDC max. (resistive load) Initial contact resistance: 10 milliohms max. at 1 A, 2 V Insulation resistance: 1000 megohms min. at 500 VDC Dielectric strength: 4000 V rms min. between terms. & frame. 3000 V rms min. between terminals Electrical life: 100,000 cycles min. at full load Mechanical life: 1,000,000 cycles min. Operating temperature range: -20°C to +55°C Solder heat resistance: 300°C max. for 5 seconds Washing not recommended</p>	<ul style="list-style-type: none"> ● .755" (19 mm) dia. and .866" (22 mm) dia. models. ● Single pole NO momentary action. ● Standard models provide protection per IP54. ● Optional sealing options provide protection to IP65. ● Extremely rugged and durable.
	MATERIALS
	<p>Contacts & terminals: Silver plated brass Bushing & Actuator: Nickel plated brass (std'd) Case: PBT Hex. Mounting Nut: Nickel plated brass</p>

ORDER FORMAT: For complete model no., fill in 2 empty boxes with selected options shown below. Example of complete model no. -
AV191003C900

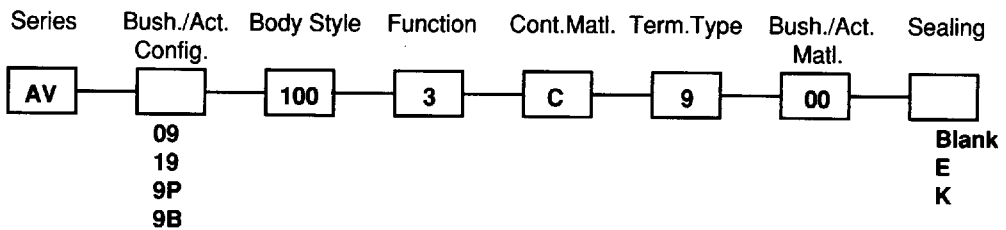

Other Bushing/Actuator materials available - flat thermoplastic Actuators available - Actuator marking available - consult factory.

19mm

Bushing/Actuator configurations

Screw terminals

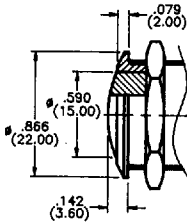

19 curved Act. & Bush.

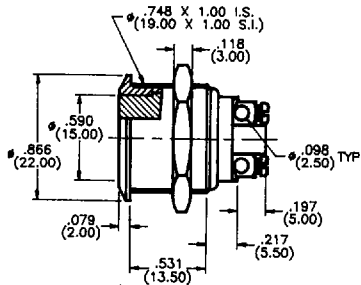

09 flat Act. & curved Bush.

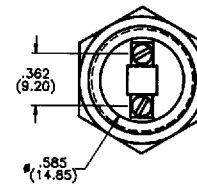

Rear view all models

9B curved Act. & Bush. with knurled nut for closer matrix mtg.

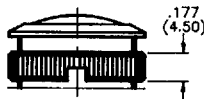

9P flat Act. & curved Bush. with knurled nut for closer matrix mtg.

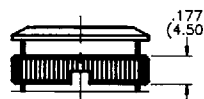

Min. dimensions for matrix mtg. for options 9B & 9P: .984" (25mm) x .984" (25mm). Order wrench p/n U1929 for knurled nut.

Blank - no sealing (std'd)

E - ① Internal seal meets IP65

K - ① Internal seal & ② front panel seals meet IP65

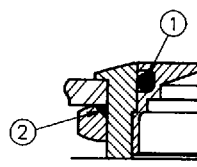
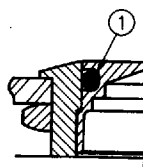

D 96E ■ 6346802 0001518 031 ■

Sealing



Schematic

Min. dimensions for matrix mounting: 1.181" (30mm) x 1.181" (30mm).

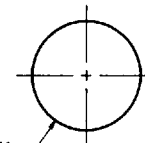

Mounting Hole

AV191003C900
(Model shown)

New!

AV SERIES SECURITY PUSHBUTTON SWITCHES

ORDER FORMAT: For complete model no., fill in 2 empty boxes with selected options shown below. Example of complete model no. - **AV021003C900**

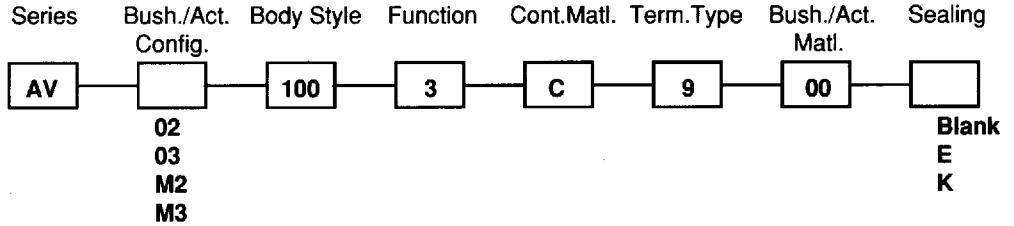

Other Bushing/Actuator materials available - flat thermoplastic Actuators available - Actuator marking available - consult factory.

SPECIFICATIONS SUBJECT TO CHANGE WITHOUT NOTICE.

22mm

Bushing/Actuator configurations

Screw terminals

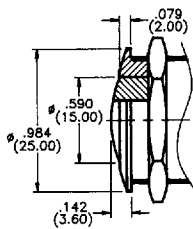

02 curved Act. & Bush.

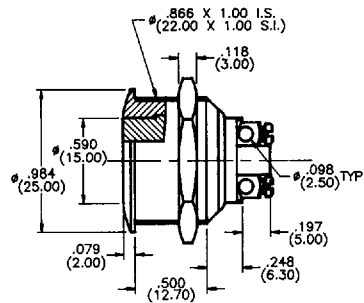

03 flat Act. & curved Bush.

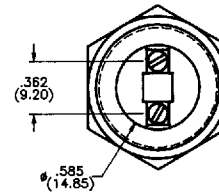

Rear view all models

M2 curved Actuator & curved Bushing with 'D' flat on Bushing
or
M3 flat Actuator & curved Bushing with 'D' flat on Bushing

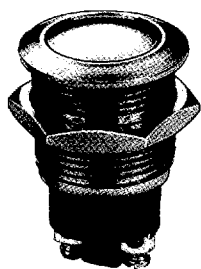
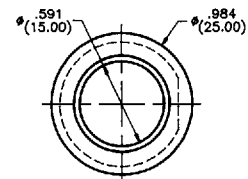

AV021003C900
(Model shown)



Schematic

Blank - no sealing (std'd)

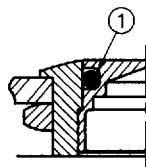

E - (1) Internal seal meets IP65

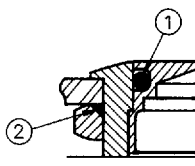

K - (1) Internal seal & (2) front panel seals meet IP65

Sealing

For 02 & 03 Bush/Act

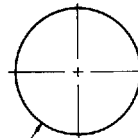

For M2 & M3 Bush/Act

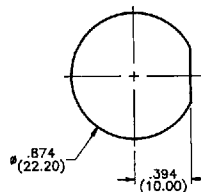

Min. dimensions for matrix mounting: 1.181" (30mm) x 1.181" (30mm).

Mounting Holes