

# IX series

Pushbutton switches for harsh environments •  
bushing Ø 12 mm • momentary NO & NC/NO



## DISTINCTIVE FEATURES

Backlighted marking in a compact case

Strong tactile feedback

NO or NC/NO

High sealing level, no space between actuator and  
bushing (IP67/IP69K)



## ENVIRONMENTAL SPECIFICATIONS

- Operating and storage temperature : -40 °C to +85 °C (-40 °F to +185 °F)
- Front panel sealing : IP67 according to IEC 60529,  
IP69K according to DIN 40050-9
- Shock resistance: 100 g according to IEC 512-4, test 6c
- Salt spray: IEC 512-6, test 11f



## ELECTRICAL SPECIFICATIONS

- Max. current/voltage rating with resistive load:
  - Gold plated contact (0):  
100 mA 28 VDC, 1,000,000 cycles
  - Silver contact (1):  
2 A 28 VDC, 100,000 cycles
- Initial contact resistance : 100 mΩ max.
- Insulation resistance : 1 GΩ min. at 500 VDC
- Dielectric strength : 1,500 Vrms
- Contact bounce : 10 ms

For W terminals, current has  
to be limited to 400 mA.



### LED COMPONENT SPECIFICATIONS

LED color	Forward current	Typ. forward voltage	Max. forward voltage
Red (R)	20 mA	1.9 V	2.5 V
Yellow (Y)	20 mA	2.3 V	2.8 V
Green (G)	20 mA	4 V	4.5 V
Blue (B)	20 mA	3.2 V	3.7 V
White (W)	20 mA	3.3 V	4 V
Red/green (F)	20 mA	Red: 2 V / green: 3.2 V	Red: 2.8 V / green: 3.7 V

A resistor must be series-connected by the user.  
Resistor value =  $\frac{\text{supply voltage} - \text{LED forward voltage}}{\text{LED forward current}}$

The company reserves the right to change specifications without notice.

# IX series

Pushbutton switches for harsh environments •  
bushing Ø 12 mm • momentary NO & NC/NO

## GENERAL SPECIFICATIONS

- Panel thickness : 1.5 to 6 mm
- Total travel : 2 mm (.078) ± 0.3 mm
- Typical operating force : 7 N ± 2 N
- Low level/mech. life : 1,000,000 cycles
- Torque : 0.55 Nm (0.6 Nm max.) applied to nut
- Soldering : 320 °C (608 °F) max. for 3 sec.

## MATERIALS

- Case : thermoplastic UL94-V0
- Actuator : silicone
- Bushing : ABS UL94 HB
- Contacts :  
0 : brass, gold plated  
1 : silver
- Output wires : AWG24, section 0.23 mm<sup>2</sup> - 500 mm
- Terminal seal : epoxy

APEM products may be recycled at end-of-life for the re-claiming of valuable metal components.

## CONNECTIONS

### WIRES TERMINALS

- Contact NO : black color / Contact NC : blue color
- LED : + : red color  
- : white color

## TERMINALS

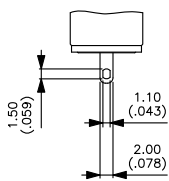

Solder lug S

## ELECTRICAL FUNCTION

### ILLUMINATED MODELS

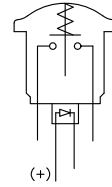

Function 3 (NO)

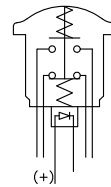

Function 5 (NC/NO)

### NON-ILLUMINATED MODELS

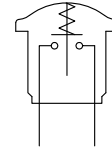

Function 3 (NO)

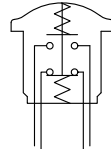

Function 5 (NC/NO)

## MOUNTING

### PANEL CUT-OUT

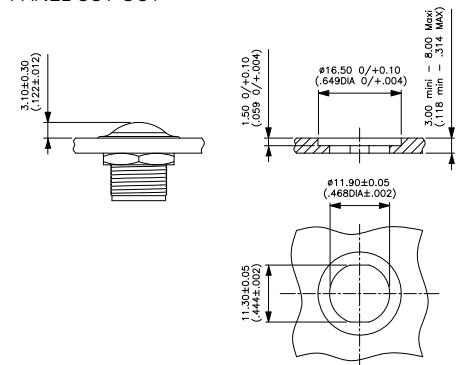

### MATRIX MOUNTING

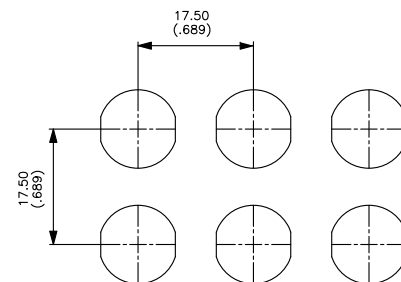

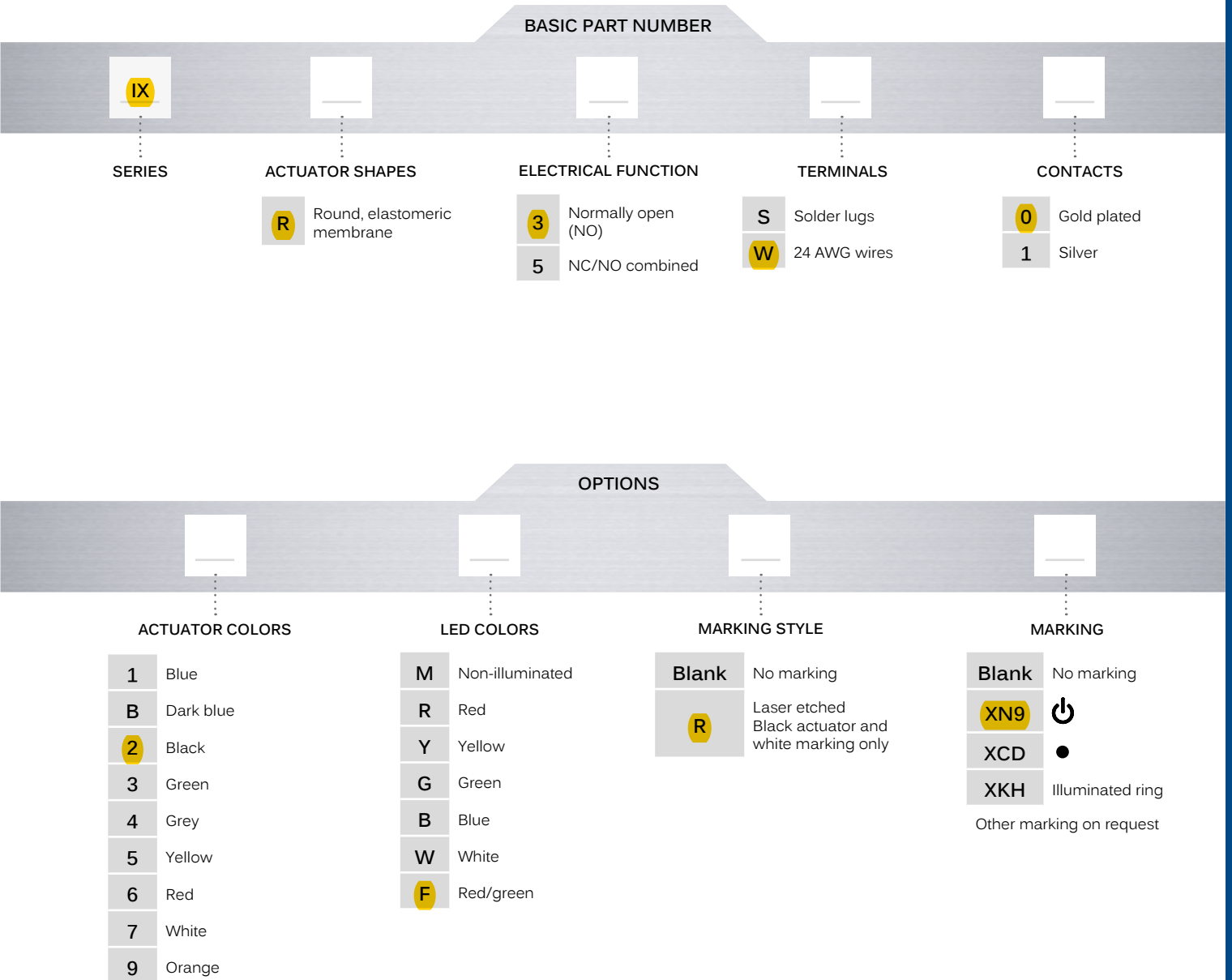

Pushbutton switches for harsh environments •  
bushing Ø 12 mm • momentary NO & NC/NO

## BUILD YOUR PART NUMBER



## ABOUT THIS SERIES

On the following pages, you will find successively basic part numbers of switches and options in the same order as in above chart.

-  **Notice** : please note that not all combinations of above numbers are available. Refer to the following pages for further information.
-  **Mounting accessories** : Standard hardware supplied : 1 hex nut 14 mm (.551) across flats and 1 O-Ring.

# IX series

Pushbutton switches for harsh environments •  
bushing Ø 12 mm • momentary NO & NC/NO

**SOLDER LUG TERMINALS  
NON-ILLUMINATED - NO**



IXR3S••M

**SOLDER LUG TERMINALS  
NON-ILLUMINATED - NC/NO**



IXR5S••M

**SOLDER LUG TERMINALS  
ILLUMINATED - NC/NO**



IXR5S

**FLYING LEAD TERMINALS  
ILLUMINATED - NC/NO**



IXR5W

→ FLAT

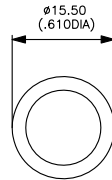
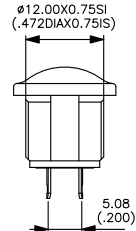
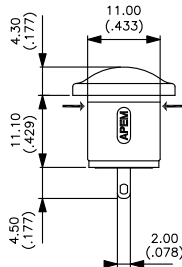

→ FLAT

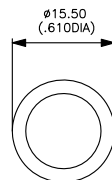
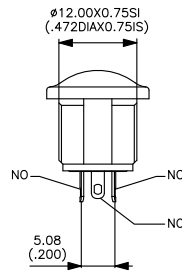
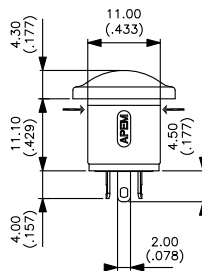

→ FLAT

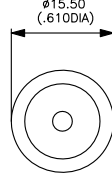
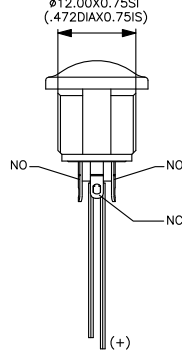
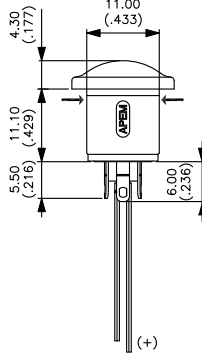

→ FLAT

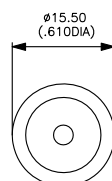
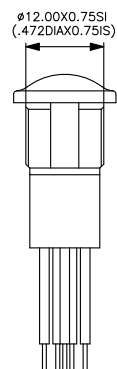
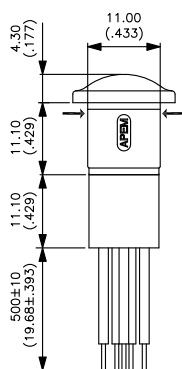

# IX series

Pushbutton switches for harsh environments •  
bushing Ø 12 mm • momentary NO & NC/NO

## ACTUATOR COLORS



1	Blue	5	Yellow
B	Dark blue	6	Red
2	Black	7	White
3	Green	9	Orange
4	Grey		

## LED COLORS



M	Non-illuminated
R	Red
Y	Yellow
G	Green
B	Blue
W	White
F	Red/green

## MARKING STYLE



Blank	No marking
R	Laser etched - Black actuator and white marking only

## MARKING



Blank	No Marking
XN9	 - Symbol "power"
XCD	 - Symbol "dot"
XXH	 - Illuminated ring

Other marking on request