

RADIAL LEADS

SkyCap®/AR Series – Automotive



GENERAL INFORMATION

AVX AR Series

Conformally Coated Radial Ledged MLC

Temperature Coefficients: C0G (NP0), X7R, X8R

3000, 2000, 1000, 200, 100, 50 Volts

Case Material: Epoxy

Lead Material: RoHS Compliant, 100% Tin

Qualified: to AEC-Q200, PPAP Available

Temperature Range: up to 150°C

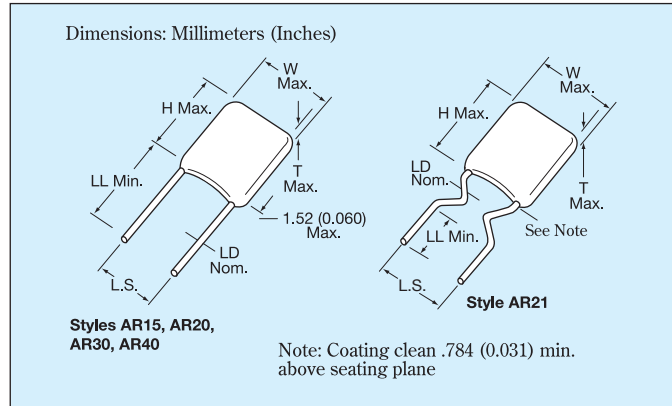

Drawings are for illustrative purposes only. Actual lead form shape could vary within stated tolerances based on body size.

HOW TO ORDER

AR21	5	F	104	M	4	R	TR1
AVX Style	Voltage	Temperature Coefficient	Capacitance	Capacitance Tolerance	Failure Rate	Leads	Packaging
	5 = 50V 1 = 100V 2 = 200V A = 1000V G = 2000V H = 3000V	A = C0G (NP0) C = X7R F = X8R L = X8L	First two digits are the significant figures of capacitance. Third digit indicates the additional number of zeros. For example, order 100,000 pF as 104. (For values below 10pF use "R" in place of decimal point, e.g., 1R4 = 1.4pF.)	C0G (NP0): C = ±.25pF D = ±.5pF F = ±1% (>50pF only) G = ±2% (>25pF only) J = ±5% K = ±10%	X7R: J = ±5% K = ±10% M = ±20%	X8R: J = ±5% K = ±10% M = ±20%	Blank: Bulk Packaging 1.0" minimum of lead length T: Trimmed leads .230" ± .030" Bulk packaging TR1: Tape and Reel Packaging AP1: Ammopack packaging See packaging specification pages 33-34
					4 = AEC-Q200	R = RoHS	



MARKING

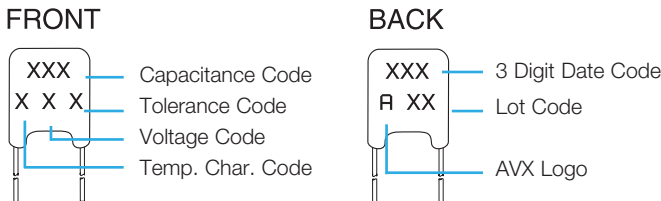

PACKAGING REQUIREMENTS

	Quantity per Bag
AR15, 20, 21, 30	1000 Pieces
AR40	500 Pieces

Note: AR15, AR20, AR21, AR30, and AR40 available on tape and reel per EIA specifications RS-468. See pages 33 and 34.

RADIAL LEADS

COG (NP0) Dielectric



SIZE AND CAPACITANCE SPECIFICATIONS

EIA Characteristic

Dimensions: Millimeters (Inches)

AVX Style		AR15			AR20			AR21		
AVX "Insertable"		AR07			AR29			AR59		
Width (W)		3.81 (.150)			5.08 (.200)			5.08 (.200)		
Height (H)		3.81 (.150)			5.08 (.200)			5.08 (.200)		
Thickness (T)		2.54 (.100)			3.175 (.125)			3.175 (.125)		
Lead Spacing (L.S.)		2.54 (.100)			2.54 (.100)			5.08 (.200)		
Lead Diameter (L.D.)		.508 (.020)			.508 (.020)			.508 (.020)		
Cap. in. pF	Industry Preferred Values in Blue	WVDC			WVDC			WVDC		
		200	100	50	200	100	50	200	100	50
1	AR----A1R0D4R									
10	AR----A100K4R									
15	AR----A150K4R									
22	AR----A220K4R									
33	AR----A330K4R									
39	AR----A390K4R									
47	AR----A470K4R									
68	AR----A680K4R									
100	AR----A101K4R									
150	AR----A151K4R									
220	AR----A221K4R									
330	AR----A331K4R									
390	AR----A391K4R									
470	AR----A471K4R									
680	AR----A681K4R									
1,000	AR----A102K4R									
1,500	AR----A152K4R									
2,200	AR----A222K4R									
3,900	AR----A392K4R									
4,700	AR----A472K4R									
6800	AR----A682K4R									
8200	AR----A822K4R									

Notes:

"Insertable" make reference to alternative AVX style using the same range of capacitance available on the matrix.

For others Styles, voltages, tolerance and lead lengths see Skycap catalog or contact factory.

Others capacitance values available upon special request.

Others styles available: AR12, AR14, AR62, AR89.



The Important Information/Disclaimer is incorporated in these specifications by reference and should be reviewed in full before placing any order.

RADIAL LEADS

X7R Dielectric



SIZE AND CAPACITANCE SPECIFICATIONS

EIA Characteristic

Dimensions: Millimeters (Inches)

AVX Style		AR15	AR20	AR21	AR30	AR40			
AVX "Insertable"		AR07	AR29	AR59	AR65	AR75			
Width (W)		3.81 (.150)	5.08 (.200)	5.08 (.200)	7.62 (.300)	10.16 (.400)			
Height (H)		3.81 (.150)	5.08 (.200)	5.08 (.200)	7.62 (.300)	10.16 (.400)			
Thickness (T)		2.54 (.100)	3.175 (.125)	3.175 (.125)	3.81 (.150)	3.81 (.150)			
Lead Spacing (L.S.)		2.54 (.100)	2.54 (.100)	5.08 (.200)	5.08 (.200)	5.08 (.200)			
Lead Diameter (L.D.)		.508 (.020)	.508 (.020)	.508 (.020)	.508 (.020)	.508 (.020)			
Cap. in. pF	Industry Preferred Values in Blue	WVDC		WVDC		WVDC		WVDC	
		100	50	100	50	100	50	100	50
470	AR----C471K4R								
1000	AR----C102K4R								
1500	AR----C152K4R								
2200	AR----C222K4R								
3300	AR----C332K4R								
4700	AR----C472K4R								
6800	AR----C682K4R								
10,000	AR----C103K4R								
15,000	AR----C153K4R								
22,000	AR----C223K4R								
33,000	AR----C333K4R								
47,000	AR----C473K4R								
68,000	AR----C683K4R								
100,000	AR----C104K4R								
150,000	AR----C154K4R								
220,000	AR----C224K4R								
330,000	AR----C334K4R								
390,000	AR----C394K4R								
470,000	AR----C474K4R								
680,000	AR----C684K4R								
1.0 uF	AR----C105K4R								
4,700,000	AR----C475K4R								
6,800,000	AR----C685K4R								
10.0 uF	AR----C106K4R								

= Extended range with 0.150" thickness maximum

Notes:

"Insertable" make reference to alternative AVX style using the same range of capacitance available on the matrix.

For others Styles, voltages, tolerance and lead lengths see Skycap catalog or contact factory.

Others capacitance values available upon special request.

Others styles available: AR12, AR14, AR62, AR89, AR32, AR38.



RADIAL LEADS

X8R Dielectric "F"



GENERAL INFORMATION

AVX AR Series

Conformally Coated Radial Ledged MLC

Temperature Coefficients: C0G (NP0), X7R, X8R

200, 100, 50 Volts

Case Material: Epoxy

Lead Material: Solderable

Qualified: to AEC-Q200

Temperature Range: up to 150°C

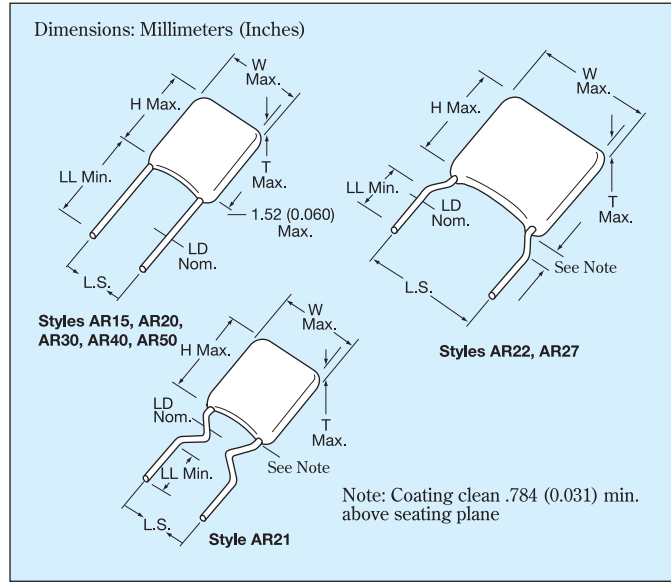

Drawings are for illustrative purposes only. Actual lead form shape could vary within stated tolerances based on body size.

HOW TO ORDER

AR21	5	F	104	M	4	R	TR1
AVX Style	Voltage	Temperature Coefficient	Capacitance	Capacitance Tolerance	Failure Rate	Leads	Packaging
	5 = 50V 1 = 100V 2 = 200V	F = X8R	First two digits are the significant figures of capacitance. Third digit indicates the additional number of zeros. For example, order 100,000 pF as 104. (For values below 10pF use "R" in place of decimal point, e.g., 1R4 = 1.4pF.)	X8R: J = ±5% K = ±10% M = ±20%	4 = AEC-Q200	R = RoHS	Blank: Bulk Packaging 1.0" minimum of lead length T: Trimmed leads .230" ± .030" Bulk packaging TR1: Tape and Reel Packaging AP1: Ammopack packaging
							See packaging specification pages 33-34



MARKING

FRONT

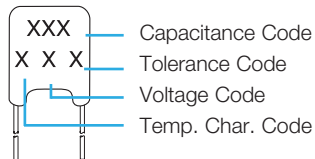

BACK

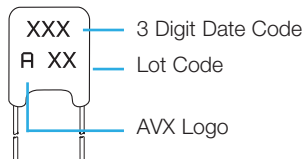

PACKAGING REQUIREMENTS

	Quantity per Bag
AR15, 20, 21, 30	1000 Pieces
AR40	500 Pieces

Note: AR15, AR20, AR21, AR30, and AR40 available on tape and reel per EIA specifications RS-468. See pages 33 and 34.



The Important Information/Disclaimer is incorporated in these specifications by reference and should be reviewed in full before placing any order.

RADIAL LEADS

X8R Dielectric



SIZE AND CAPACITANCE SPECIFICATIONS

EIA Characteristic Dimensions: Millimeters (Inches)

AVX Style		AR20	AR21				
AVX "Insertable"		AR29	AR59				
Width (W)		5.08 (.200)	5.08 (.200)				
Height (H)		5.08 (.200)	5.08 (.200)				
Thickness (T)		3.175 (.125)	3.175 (.125)				
Lead Spacing (L.S.)		2.54 (.100)	5.08 (.200)				
Lead Diameter (L.D.)		.508 (.020)	.508 (.020)				
Cap. in. pF	Industry Preferred Values in Blue	WVDC			WVDC		
		200	100	50	200	100	50
1,000	AR----F102K4R						
10,000	AR----F103K4R						
100,000	AR----F104K4R						
330,000	AR----F334K4R						

Notes:

"Insertable" make reference to alternative AVX style using the same range of capacitance available on the matrix.
 For others Styles, voltages, tolerance and lead lengths see Skycap catalog or contact factory.
 Others capacitance values available upon special request.
 Others styles available: AR14, AR62, AR89.



RADIAL LEADS

X8L Dielectric



STYLES AND CAPACITANCE SPECIFICATIONS

EIA Characteristics

AVX Style		AR15		AR20		AR21	
AVX "Insertable"		AR07		AR29		AR59	
Cap. in pF	Industry Preferred Values	WVDC		WVDC		WVDC	
		100	50	100	50	100	50
470	AR____L471K4R						
1,000	AR____L102K4R						
1,500	AR____L152K4R						
2,200	AR____L222K4R						
3,300	AR____L332K4R						
4,700	AR____L472K4R						
6,800	AR____L682K4R						
10,000	AR____L103K4R						
15,000	AR____L153K4R						
22,000	AR____L223K4R						
33,000	AR____L333K4R						
47,000	AR____L473K4R						
68,000	AR____L683K4R						
100,000	AR____L104K4R						
150,000	AR____L154K4R						
220,000	AR____L224K4R						
330,000	AR____L334K4R						
390,000	AR____L394K4R						
470,000	AR____L474K4R						
680,000	AR____L684K4R						
1.0 uF	AR____L105K4R						
4700,000	AR____L475K4R						
6800,000	AR____L685K4R						
10.0 uF	AR____L106K4R						



The Important Information/Disclaimer is incorporated in these specifications by reference and should be reviewed in full before placing any order.

RADIAL LEADS

High Voltage Automotive Product SkyCap Capacitors - X7R Dielectric



SIZE AND CAPACITANCE SPECIFICATIONS

EIA Characteristic Dimensions: Millimeters (Inches)

	AVX Style	AR20	AR21	AR22	AR27	AR30	
	AVX "Insertable"	AR29	AR59	N/A	N/A	AR65	
Cap. in. pF	Industry Preferred Values in Blue	WVDC 1000	WVDC 1000	WVDC 1000	WVDC 1000	WVDC 2000 3000	
470	AR____C471K4R						
1000	AR____C102K4R						
1500	AR____C152K4R						
2200	AR____C222K4R						
3300	AR____C332K4R						
4700	AR____C472K4R						
6800	AR____C682K4R						
10,000	AR____C103K4R						
15,000	AR____C153K4R						
22,000	AR____C223K4R						
47,000	AR____C473K4R						
68,000	AR____C683K4R						

For others Styles, voltages, tolerance and lead lengths see Skycap catalog or contact factory.

RADIAL LEADS

SkyCap® Configurations by Lead Spacing



LEAD SPACING .100 ±.030				Dimensions: Inches (Millimeters)			
<p>AR07/SR07* (T=.100)</p>	<p>AR14/SR14 (T=.100)</p>	<p>AR15/SR15* (T=.100)</p>	<p>AR20/SR20* (T=.125)</p>	<p>AR29/SR29* (T=.125)</p>	<p>AR62/SR62* (T=.125)</p> <p>Leads = #22 AWG</p>	<p>SR62-LP* (T=.100)</p> <p>Leads = #22 AWG</p>	

LEAD SPACING .200 ±.030					Dimensions: Inches (Millimeters)									
<p>AR12/SR12* (T=.100)</p>	<p>SR13* (T=.125)</p>	<p>AR21/SR21* (T=.125)</p>	<p>SR21-85* (T=.125)</p>	<p>SR28* (T=.125)</p>	<p>AR30/SR30* (T=.150)</p>	<p>SR30-LP* (T=.150)</p>	<p>AR32/SR32* (T=.150)</p>	<p>AR40/SR40* (T=.150)</p>	<p>AR59/SR59* (T=.125)</p>	<p>SR61 (T=.150)</p>	<p>SR63* (T=.150)</p>	<p>SR64* (T=.150)</p> <p>Leads = #22 AWG</p>	<p>SR64-LP* (T=.150)</p> <p>Leads = #22 AWG</p>	<p>AR65/SR65* (T=.150)</p>

*SL style available in all SR configurations.



The Important Information/Disclaimer is incorporated in these specifications by reference and should be reviewed in full before placing any order.

RADIAL LEADS

SkyCap® Configurations by Lead Spacing

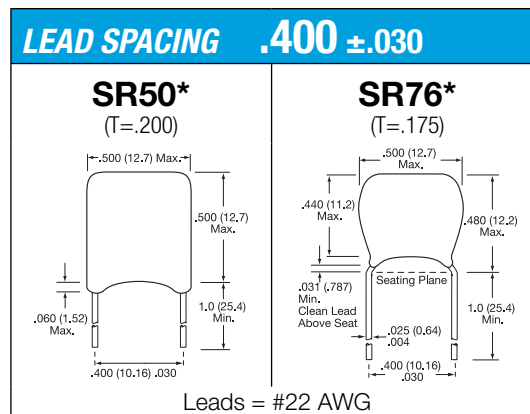
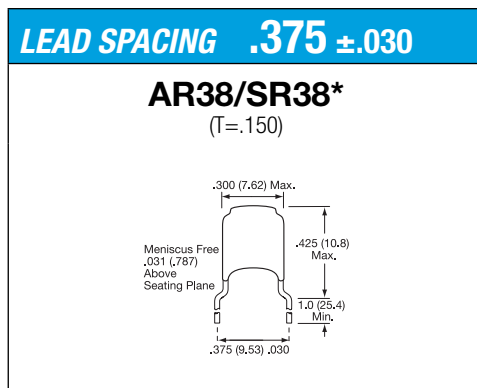
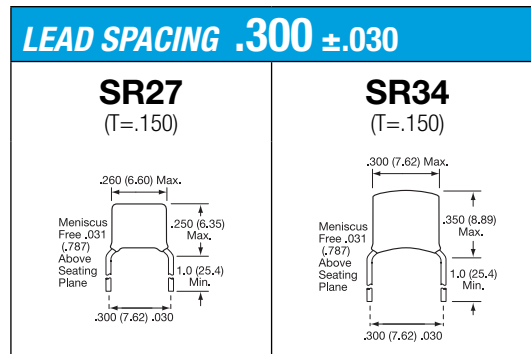
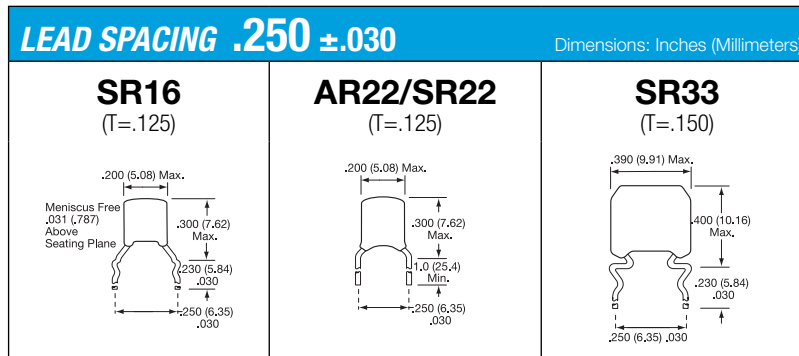
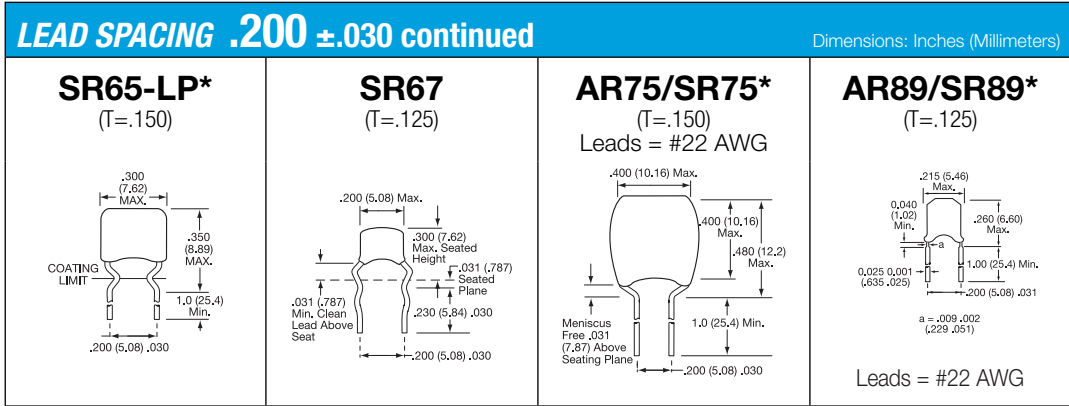

- NOTES:**
1. All leads are #24 AWG unless otherwise noted.
 2. Available in tape and reel packaging(*).
 3. Other styles are also available, contact factory.
 4. (T = XXX) under type designation is maximum thickness in inches.

Drawings are for illustrative purposes only.
Actual lead form shape could vary within stated tolerances based on body size.

*SL style available in all SR configurations.



The Important Information/Disclaimer is incorporated in these specifications by reference and should be reviewed in full before placing any order.

IMPORTANT INFORMATION/DISCLAIMER

All product specifications, statements, information and data (collectively, the “Information”) in this datasheet or made available on the website are subject to change. The customer is responsible for checking and verifying the extent to which the Information contained in this publication is applicable to an order at the time the order is placed. All Information given herein is believed to be accurate and reliable, but it is presented without guarantee, warranty, or responsibility of any kind, expressed or implied.

Statements of suitability for certain applications are based on AVX’s knowledge of typical operating conditions for such applications, but are not intended to constitute and AVX specifically disclaims any warranty concerning suitability for a specific customer application or use.

ANY USE OF PRODUCT OUTSIDE OF SPECIFICATIONS OR ANY STORAGE OR INSTALLATION INCONSISTENT WITH PRODUCT GUIDANCE VOIDS ANY WARRANTY.

The Information is intended for use only by customers who have the requisite experience and capability to determine the correct products for their application. Any technical advice inferred from this Information or otherwise provided by AVX with reference to the use of AVX’s products is given without regard, and AVX assumes no obligation or liability for the advice given or results obtained.

Although AVX designs and manufactures its products to the most stringent quality and safety standards, given the current state of the art, isolated component failures may still occur. Accordingly, customer applications which require a high degree of reliability or safety should employ suitable designs or other safeguards (such as installation of protective circuitry or redundancies) in order to ensure that the failure of an electrical component does not result in a risk of personal injury or property damage.

Unless specifically agreed to in writing, AVX has not tested or certified its products, services or deliverables for use in high risk applications including medical life support, medical device, direct physical patient contact, water treatment, nuclear facilities, weapon systems, mass and air transportation control, flammable environments, or any other potentially life critical uses. Customer understands and agrees that AVX makes no assurances that the products, services or deliverables are suitable for any high-risk uses. Under no circumstances does AVX warrant or guarantee suitability for any customer design or manufacturing process.

Although all product-related warnings, cautions and notes must be observed, the customer should not assume that all safety measures are indicated or that other measures may not be required.