



Features

- RoHS compliant*
- Zener voltages 2.0 V to 39 V
- Fits SOD323 and SOD523



This series is obsolete and not recommended for new designs.

CD0603/1005-Z Surface Mount Zener Diode Series

General Information

The markets of portable communications, computing and video equipment are challenging the semiconductor industry to develop increasingly smaller electronic components.

Bourns offers Zener Diodes for voltage reference applications, in compact chip package 0603 and 1005 size format, which offer PCB real estate savings and are considerably smaller than most competitive parts. The Zener Diodes have a zener voltage range between 2.0 V and 39 V.

Bourns® Chip Diodes conform to JEDEC standards, are easy to handle on standard pick and place equipment and their flat configuration minimizes roll away.

Electrical and Thermal Characteristics (@ $T_A = 25\text{ }^\circ\text{C}$ Unless Otherwise Noted)

Parameter	Symbol	CD1005-Z	CD0603-Z	Unit
Power Dissipation @ $T=25\text{ }^\circ\text{C}$	P_D	200	150	mW
Peak Forward Surge Current 8.3 ms Single Half Sine-wave Superimposed on Rated Load (JEDEC Method)	I_{FSM}	2.0	2.0	A
Operating and Storage Temperature Range	T_J	-55 to +125	-55 to +125	$^\circ\text{C}$

Notes:

1. Pulse test width $PW=300\text{ }\mu\text{sec}$, 1 % duty cycle.
2. Mounted on P.C. board with $0.2 \times 0.2\text{ "}$ ($5.0 \times 5.0\text{ mm}$) copper pad areas.

How To Order

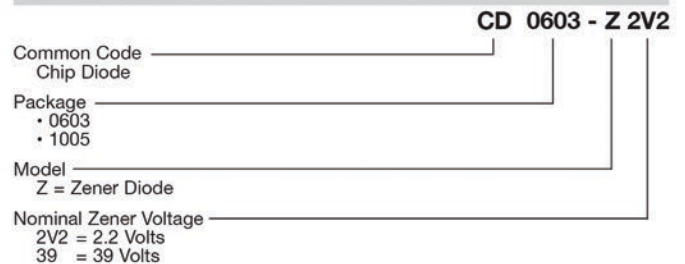

BOURNS®

Asia-Pacific:

Tel: +886-2 2562-4117 • Fax: +886-2 2562-4116

EMEA:

Tel: +36 88 520 390 • Fax: +36 88 520 211

The Americas:

Tel: +1-951 781-5500 • Fax: +1-951 781-5700

www.bourns.com

*RoHS Directive 2002/95/EC Jan. 27, 2003 including annex and RoHS Recast 2011/65/EU June 8, 2011.

Specifications are subject to change without notice.

The device characteristics and parameters in this data sheet can and do vary in different applications and actual device performance may vary over time. Users should verify actual device performance in their specific applications.

Applications

- DC-DC converters
- Portable electronics
- Industrial controllers
- Desktop PCs and notebooks

CD0603/1005-Z Surface Mount Zener Diode Series

BOURNS®

Electrical Characteristics (@ T_A = 25 °C Unless Otherwise Noted)

Part Number		Part Marking	Zener Voltage			Zener Impedance				Reverse Current	
			VZ			Z _{ZT}	I _Z	Z _{ZK}	I _Z	I _R	
CD0603	CD1005		Min. V	Max. V	I _Z (mA)	Ohms	mA	Ohms	mA	μA	VR
-Z2	-Z2	Z0	1.90	2.1	5	100	5	600	1	100	1
-Z2V2	-Z2V2	Z1	2.09	2.31	5	100	5	600	1	100	1
-Z2V4	-Z2V4	Z2	2.28	2.52	5	85	5	600	1	100	1
-Z2V7	-Z2V7	Z3	2.57	2.84	5	83	5	500	1	75	1
-Z3	-Z3	Z4	2.85	3.15	5	95	5	500	1	50	1
-Z3V3	-Z3V3	Z5	3.14	3.47	5	95	5	500	1	25	1
-Z3V6	-Z3V6	Z6	3.42	3.78	5	95	5	500	1	15	1
-Z3V9	-Z3V9	Z7	3.71	4.10	5	95	5	500	1	10	1
-Z4V3	-Z4V3	Z8	4.09	4.52	5	95	5	500	1	5	1
-Z4V7	-Z4V7	Z9	4.47	4.94	5	78	5	500	1	5	2
-Z5V1	-Z5V1	ZA	4.85	5.36	5	60	5	480	1	0.1	0.8
-Z5V6	-Z5V6	ZB	5.32	5.88	5	40	5	400	1	0.1	1
-Z6V2	-Z6V2	ZC	5.89	6.51	5	10	5	200	1	0.1	2
-Z6V8	-Z6V8	ZE	6.46	7.14	5	8	5	150	1	0.1	3
-Z7V5	-Z7V5	ZF	7.13	7.88	5	7	5	50	1	0.1	5
-Z8V2	-Z8V2	ZG	7.79	8.61	5	7	5	50	1	0.1	6
-Z9V1	-Z9V1	ZH	8.65	9.56	5	10	5	50	1	0.1	7
-Z10	-Z10	ZJ	9.50	10.50	5	15	5	70	1	0.1	7.5
-Z11	-Z11	ZK	10.45	11.55	5	20	5	70	1	0.1	8.5
-Z12	-Z12	ZM	11.40	12.60	5	20	5	90	1	0.1	9
-Z13	-Z13	ZN	12.35	13.65	5	25	5	110	1	0.1	10
-Z15	-Z15	ZP	14.25	15.75	5	30	5	110	1	0.1	11
-Z16	-Z16	ZQ	15.20	16.80	5	40	5	170	1	0.1	12
-Z18	-Z18	ZR	17.10	18.90	5	50	5	170	1	0.1	14
-Z20	-Z20	ZS	19.00	21.00	5	50	5	220	1	0.1	15
-Z22	-Z22	ZT	20.90	23.10	5	55	5	220	1	0.1	17
-Z24	-Z24	ZU	22.80	25.20	5	80	5	220	1	0.1	18
-Z27	-Z27	ZV	25.65	28.35	5	80	5	250	1	0.1	20
-Z30	-Z30	ZW	28.50	31.50	5	80	5	250	1	0.1	23
-Z33	-Z33	ZX	31.35	34.65	5	80	5	250	1	0.1	25
-Z36	-Z36	ZY	34.20	37.80	5	90	5	250	1	0.1	27
-Z39	-Z39	ZZ	37.05	40.95	5	90	5	300	1	0.1	39

Specifications are subject to change without notice.

The device characteristics and parameters in this data sheet can and do vary in different applications and actual device performance may vary over time. Users should verify actual device performance in their specific applications.

CD0603/1005-Z Surface Mount Zener Diode Series



Product Dimensions

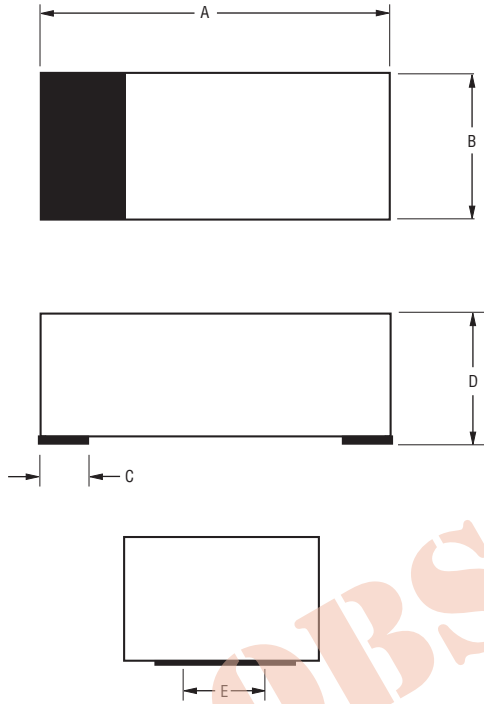

Dimension	0603	1005
A	$\frac{1.60 - 1.80}{(0.063 - 0.071)}$	$\frac{2.40 - 2.60}{(0.095 - 0.102)}$
B	$\frac{0.80 - 1.00}{(0.031 - 0.039)}$	$\frac{1.10 - 1.30}{(0.043 - 0.051)}$
C	$\frac{0.45}{(0.018)}$ Typ.	$\frac{0.50}{(0.020)}$ Typ.
D	$\frac{0.70 - 0.85}{(0.027 - 0.033)}$	$\frac{0.70 - 0.90}{(0.027 - 0.035)}$
E	$\frac{0.70}{(0.028)}$ Typ.	$\frac{1.00}{(0.039)}$ Typ.

DIMENSIONS: $\frac{\text{MM}}{\text{(INCHES)}}$

Recommended Pad Layout

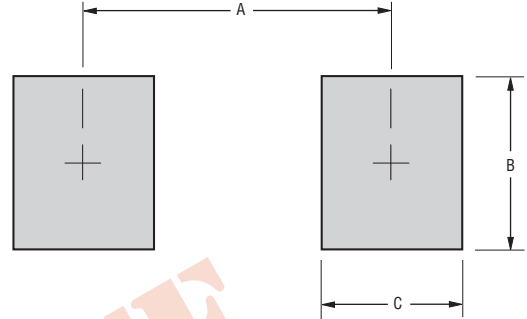

Dimension	0603	1005
A (Max.)	$\frac{1.25}{(0.049)}$	$\frac{2.00}{(0.079)}$
B (Min.)	$\frac{1.00}{(0.039)}$	$\frac{1.3}{(0.051)}$
C (Min.)	$\frac{0.6}{(0.024)}$	$\frac{0.7}{(0.028)}$

DIMENSIONS: $\frac{\text{MM}}{\text{(INCHES)}}$

Physical Specifications

Case0603(1608) / 1005(2512) Molded plastic
 TerminalsGold plated, solderable per MIL-STD-750,
 Method 2026
 PolarityIndicated by cathode band
 Mounting PositionAny

Specifications are subject to change without notice.
 The device characteristics and parameters in this data sheet can and do vary in different applications and actual device performance may vary over time.
 Users should verify actual device performance in their specific applications.

CD0603/1005-Z Surface Mount Zener Diode Series



Rating and Characteristic Curves

Temperature Sensitivity

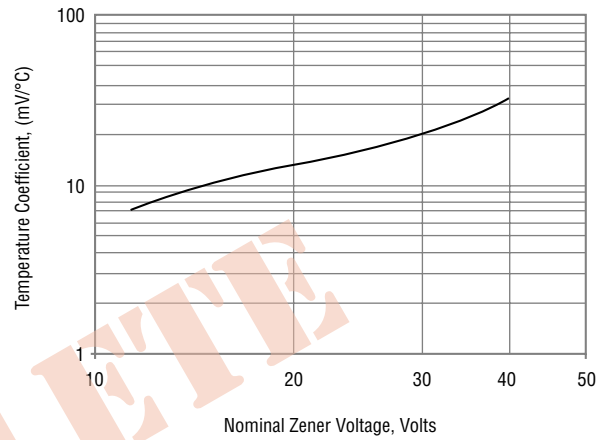
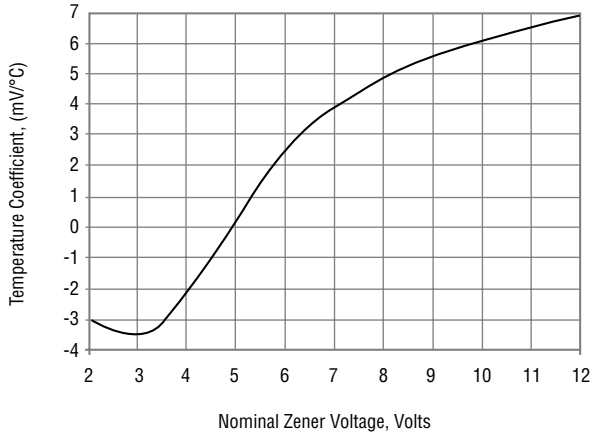

Zener Current vs. Zener Voltage Characteristics

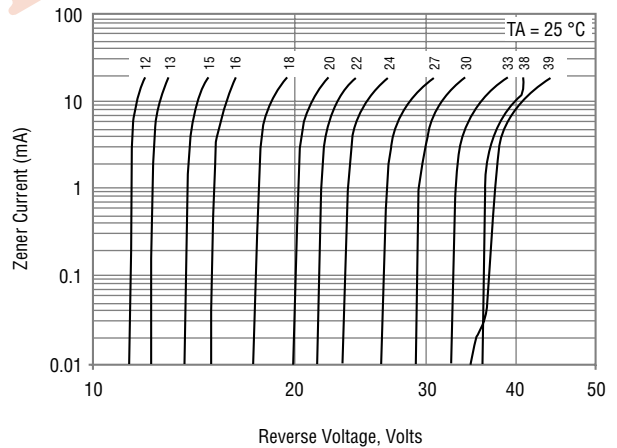
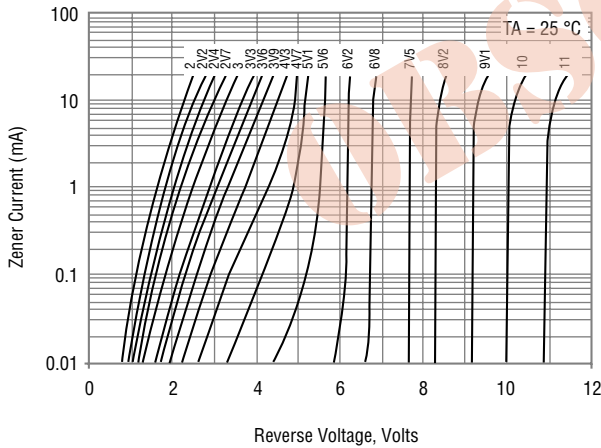

Derating Curve

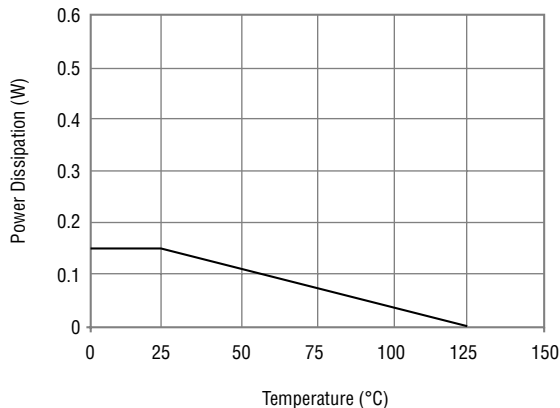

Typical Junction Capacitance

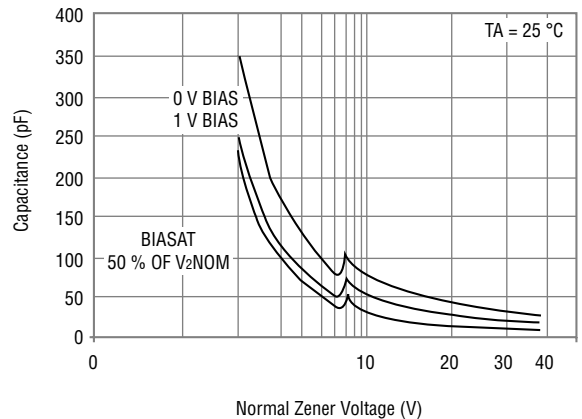

Specifications are subject to change without notice.
The device characteristics and parameters in this data sheet can and do vary in different applications and actual device performance may vary over time.
Users should verify actual device performance in their specific applications.

CD0603/1005-Z Surface Mount Zener Diode Series

BOURNS®

Rating and Characteristic Curves:

Zener Impedance vs. Voltage

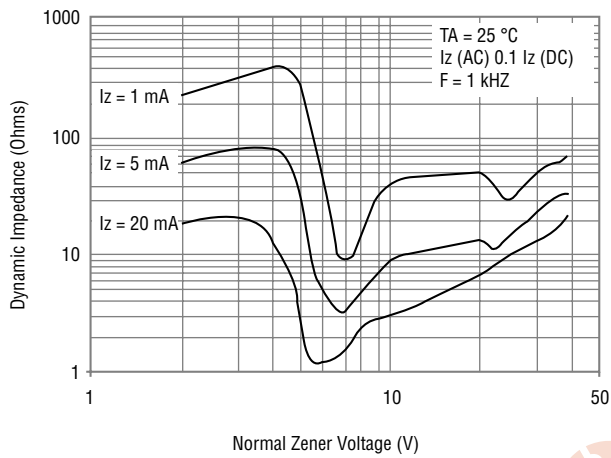

Forward Current vs. Voltage

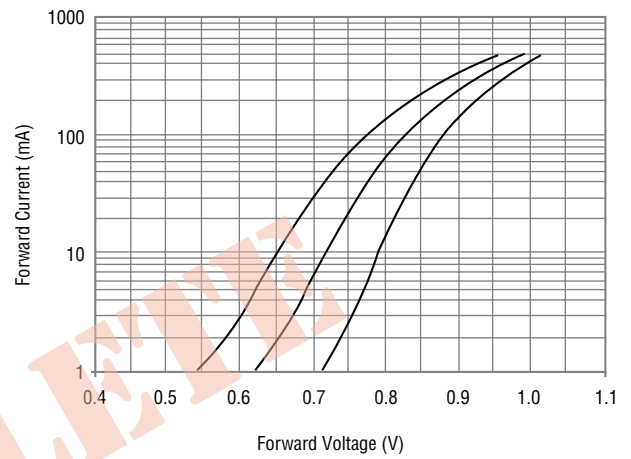

OBSOLETE

Specifications are subject to change without notice.

The device characteristics and parameters in this data sheet can and do vary in different applications and actual device performance may vary over time. Users should verify actual device performance in their specific applications.

CD0603/1005-Z Surface Mount Zener Diode Series

BOURNS®

Packaging Information

The product will be dispensed in Tape and Reel format (see diagram below).

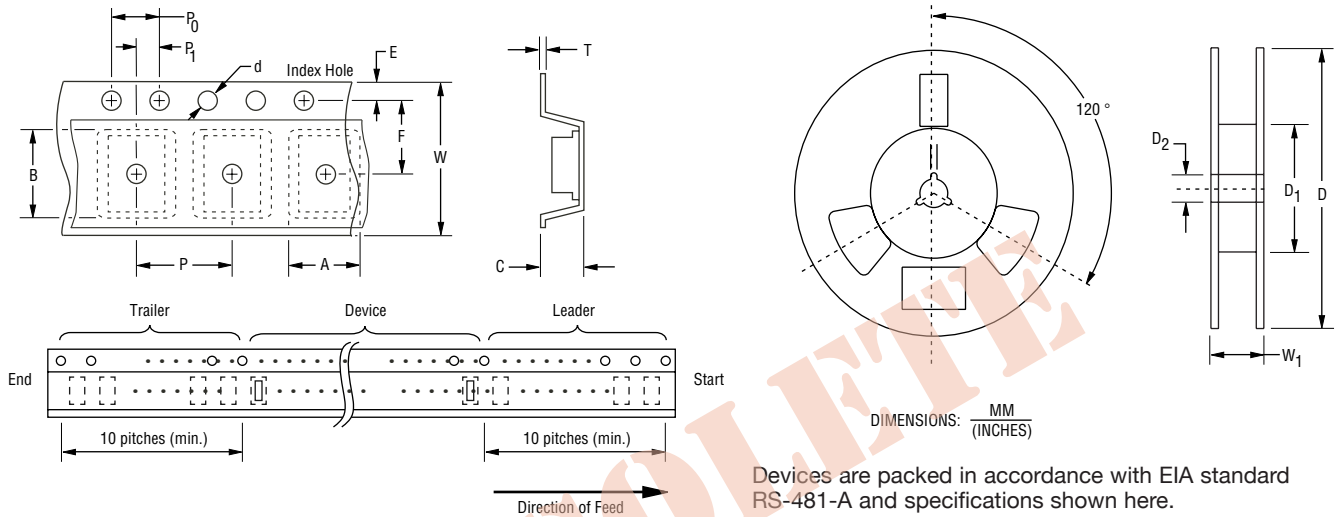

Item	Symbol	0603	1005
Carrier Width	A	$\frac{1.00 \pm 0.10}{(0.039 - 0.004)}$	$\frac{1.55 \pm 0.10}{(0.061 - 0.004)}$
Carrier Length	B	$\frac{1.85 \pm 0.10}{(0.073 - 0.004)}$	$\frac{2.65 \pm 0.10}{(0.104 - 0.004)}$
Carrier Depth	C	$\frac{1.00 \pm 0.10}{(0.039 - 0.004)}$	$\frac{1.05 \pm 0.10}{(0.041 - 0.004)}$
Sprocket Hole	d	$\frac{1.55 \pm 0.05}{(0.061 - 0.002)}$	$\frac{1.55 \pm 0.10}{(0.061 - 0.004)}$
Reel Outside Diameter	D	$\frac{178}{(7.008)}$	$\frac{178}{(7.008)}$
Reel Inner Diameter	D ₁	$\frac{60.0}{(2.362)} \text{ MIN.}$	$\frac{60.0}{(2.362)} \text{ MIN.}$
Feed Hole Diameter	D ₂	$\frac{13.0 \pm 0.20}{(0.512 - 0.008)}$	$\frac{13.0 \pm 0.20}{(0.512 - 0.008)}$
Sprocket Hole Position	E	$\frac{1.75 \pm 0.10}{(0.069 - 0.004)}$	$\frac{1.75 \pm 0.10}{(0.069 - 0.004)}$
Punch Hole Position	F	$\frac{3.50 \pm 0.05}{(0.138 - 0.002)}$	$\frac{3.50 \pm 0.05}{(0.138 - 0.002)}$
Punch Hole Pitch	P	$\frac{4.00 \pm 0.10}{(0.157 - 0.004)}$	$\frac{4.00 \pm 0.10}{(0.157 - 0.004)}$
Sprocket Hole Pitch	P ₀	$\frac{4.00 \pm 0.10}{(0.157 - 0.004)}$	$\frac{4.00 \pm 0.10}{(0.157 - 0.004)}$
Embossment Center	P ₁	$\frac{2.00 \pm 0.05}{(0.079 - 0.002)}$	$\frac{2.00 \pm 0.05}{(0.079 - 0.002)}$
Overall Tape Thickness	T	$\frac{0.20 \pm 0.05}{(0.008 - 0.002)}$	$\frac{0.25 \pm 0.05}{(0.010 - 0.002)}$
Tape Width	W	$\frac{8.00 \pm 0.20}{(0.315 - 0.008)}$	$\frac{8.00 \pm 0.20}{(0.315 - 0.008)}$
Reel Width	W ₁	$\frac{13.5}{(0.531)} \text{ MAX.}$	$\frac{13.5}{(0.531)} \text{ MAX.}$
Quantity per Reel	--	4,000	4,000

REV. 10/15

Specifications are subject to change without notice.

The device characteristics and parameters in this data sheet can and do vary in different applications and actual device performance may vary over time.

Users should verify actual device performance in their specific applications.