



ITT

Interconnect Solutions  
Cannon, VEAM, BIW

Defining **innovative**  
**aviation, military, and**  
**industrial circulars** since the DC-1,  
over **70 years** ago



*Engineered for life*

# MS/CV345\* MIL-C-5015 Rear Release Connectors

Circular  
A

## Standard Circular High Environmental Connectors

These connectors are available for many applications, from commercial/industrial and mass transportation systems to the most stringent high reliability military and space requirements.

The MS/CV345\* connector manufactured by ITT Cannon to MIL-C-5015 (Navy) is a threaded coupling, removable rear release crimp contact type. Fully interchangeable with existing MIL-C-5015 and threaded MIL-C-83723 Series II (USAF) type connectors, they provide for minimum effort and high economy upgrades for existing applications. In addition, they offer simplified design for new and interphase equipment.

MS/CV connectors converted under MIL-C-5015 (Navy) utilize fluid resistant elastomers to provide maximum protection against degrading fuels, oils, coolants and cleansers.

Temperature withstanding capabilities range from -55°C to +200°C depending upon the class. The use of electroless nickel and cadmium plating for hardware finishes gives the connectors maximum protection from the above factors. High quality manufacturing processes and materials combine to insure the optimum performance and materials combine to insure the optimum range of environmental conditions.

The MS/CV connector manufactured by ITT Cannon is available in five shell styles and 72 contact arrangements accommodating from 1 to 52 contact (sizes 0, 4, 8, 12, and 16).

This connectors series is manufactured to accommodate the following backshells: M85049/43 (MS3415), M8504/31 or /60 (MS3416), M85049/52 (MS3417), M85049/51 (MS 3418) and M85049/26 (MS3419). Shell polarization is effected by a single keyway and key, standard MS polarization positions are available to prevent mismatching.

\*For information regarding MIL-C-83723 Series II (CVA) connectors, please call ITT Cannon, 714-557-4700

## Features

**Universal Insertion/Extraction Tool Style** – A single, expendable plastic tool is used for insertion and extraction of both pins and sockets. Tool never touches engaging ends of contacts, cannot damage insert.

**Simple, Strong Contact Design** – One basic configuration eliminates undercuts, maximizes bend resistance for positive contact mating.

**Interfacial Pin Insert Seal** – Universal interconnect permits design of raised moisture barriers around each pin which mate into lead-in chamfers of hard face socket insert for individual contact sealing. Interfacial seal is never touched by service tools.

**Superior Contact Stability** – “Closed-down” design of each contact cavity in the insulator support each contact, minimizes contact splaying.

**Closed Entry Socket Insert** – Hard dielectric socket face of mating connector has lead-in chamfers for positive alignment of pins and sockets.

**Simplified Assembly Operations** – One standard procedure for assembling connectors and contacts, standard MS crimp tools, all servicing of contacts accomplished from the rear of the connector.

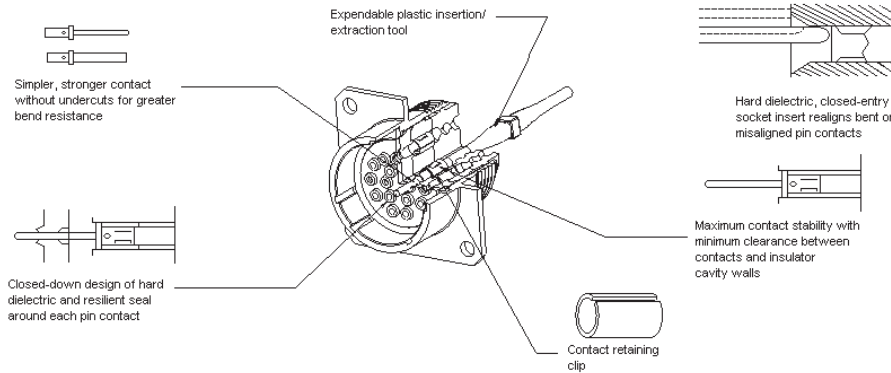

## How to Order

### PREFIX

- MS - Complies with MIL-C-5015
- CV - ITT Cannon Prefix

### SHELL STYLES

- MS3450 - Wall Mounting Receptacle
- MS3451 - Cable Connecting Receptacle
- MS3456 - Cable Connecting Plug
- MS3459 - Cable Connecting Plug with Self-Locking Coupling Nut
- CV3450 - Wall Mounting Receptacle
- CV3451 - Cable Connecting Receptacle
- CV3452 - Box Mounting Receptacle
- CV3456 - Cable Connecting Plug
- CV3459 - Cable Connecting Plug with Self-Locking Coupling Nut

### CONNECTOR CLASSES

- Class KT, KS - Firewall
- Class LS - High Temperature, Fluid Resistant
- Class W - General Purpose

### SHELL SIZE

See Pages A-108 and A-110

### PREFIX

### SERIES

### SHELL STYLE

### CONNECTOR CLASS

### SHELL SIZE

### CONTACT ARRANGEMENT

### CONTACT SEX

### ALTERNATE INSERT POSITION

### LESS CONTACTS

### CONTACT ARRANGEMENT

See page A-111 and A-112

### CONTACT SEX

- P - Pin
- S - Socket
- \*A - Less Pin Contact
- \*B - Less Socket Contact

\*Used only when other than power contacts are to be installed (i. e., Shielded, thermocouple, etc.)

CV 345 6 W 18 - 9 P W \*  
MS 345 6 W 18 - 9 P W

### ALTERNATE INSERT POSITION

W, X, Y, and Z (Omit for “Normal”)

### LESS CONTACTS

Use “F0” when connectors are ordered less contacts, sealing plug and insertion/extraction tool (“F0” is not stamped on connector).



Dimensions shown in inches (mm)  
Specifications and dimensions subject to change

www.ittcannon.com



A

Circular

### Performance Specifications

Class	Temp. °C	Moisture, Fluid and Fuel Resistant	Shell Material	Size Finish
W	-55 to +175	Yes	Aluminum per QQ-A-225 or QQ-A-591	Olive drab over cad plate
L	-55 to +200	Yes		Electroless nickel
KT	-55 to +175	Yes	Steel per QQ-S-637	Olive drab over card plate
KS LS	-55 to +200	Yes Steel		Stainless Steel

NOTE: Resistant to hydraulic fluid per MIL-H-5606 or skydrol (LD), lubricating oils per MIL-L-7808 and MIL-L-23699, cleaners CeeBee 694 or Aerosafe 2300, jet engine fuel per MIL-J-5624 Grade JP-5, Ethylene Glycol, and Collanol 25.

#### Contacts (Crimp Removable Rear Release)

Material - Copper Alloy  
Finish - Size 16 - Gold over Nickel  
Size 12, 8, 4 and 0 - silver plated

#### Wire Range Accommodations

Contact Size	Wire Size	Minimum	Maximum
16-16	20, 18, 16	.053 (1.35)	.103 (2.62)
12-12	14, 12	.085 (2.16)	.158 (4.01)
8-8	10, 8	.132 (3.35)	.255 (6.48)
4-4	6, 4	.237 (6.02)	.370 (9.40)
0-0	2, 0	.360 (9.14)	.550 (13.97)

<sup>1</sup> Wire Reference - MIL-W16878, MIL-W-22759, Mil- 81381, MIL-C-915, MIL-C- 24145 and MIL-C 2194.

<sup>2</sup> MS3348 brushing required in crimp barrel to accommodate 10, 6 and 2 wire sizes - they are ordered separately, consult factory.

### Test Data

#### High Potential Test Voltage

MS/CV connectors show no evidence of breakdown when the test voltage given below is applied between the two closes contacts and between, the shell and the contacts closest to the shell for a period of one minute.

Service Rating	Test Voltage (ms) 60cps	Suggested Operating Voltage	
		DC	AC (ms)
Inst.	1000	250	200
A	2000	700	500
D	2800	1250	900
E	3500	1750	1250
B	4500	2450	1750
C	7000	4200	3000

\*As indicated in previous MS Specification and to be used by the designer only as a guide.

#### Test Current

Test current ratings of contacts and allowable voltage drop under test conditions when assembled as in service are shown below. Maximum total current to be carried per connector is the same as that allowable in wire bundles as specified in MIL-W-5088.

#### Current Rating with Silver Plated Wire (MIL-C-5015 test method)

Contact Size	Test Current (amps)	Potential Drop (millivolts)
16	13	49
12	23	42
8	46	26
4	80	23
0	150	21

### MS Alternate Positions

All views are looking into front of pin insert or rear of socket insert.



Normal Position

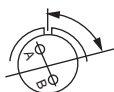

Position W

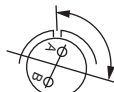

Position X

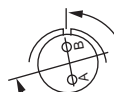

Position Y

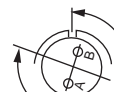

Position Z

Shell Size	No. of Contacts	Contact Arr.	W	X	Degrees Y	Z
8S	1 #16	8S-1	-	-	-	-
10S	1 #16	10S-2	-	-	-	-
10SL	2 #16	10SL-4	-	-	-	-
12	1 #12	12-5	-	-	-	-
12S	2 #16	12S-3	70	145	215	290
14S	2 #16	14S-9	70	145	215	290
	3 #16	14S-7	70	145	215	290
	4 #16	14S-2	90	180	270	-
	5 #16	14S-5	-	110	-	-
	6 #16	14S-6	-	-	-	-
16S	2 #16	16S-4	35	110	250	325
	5 #16	16S-8	-	170	265	-
	7 #16	16S-1	80	-	-	280
16	2 #12	16-11	35	110	250	325
	3 #12	16-10	90	180	270	-
	2 #16, 2 #12	16-9	35	110	250	325
	2 #16, 1 #8	16-7	80	110	250	280
18	4 #16	18-4	35	110	250	325
	4 #12	18-10	-	120	240	-
	3 #16	18-22	70	145	215	290
	5 #12	18-11	-	170	265	-
	6 #12	18-12	80	-	-	280
	5 #16, 2 #12	18-9	80	110	250	280
	7 #16, 1 #12	18-8	70	-	-	290
	10 #16	18-1	70	145	215	290

Shell Size	No. of Contacts	Contact Arr.	W	X	Degrees Y	Z
20	1 #0	20-2	-	-	-	-
	4 #12	20-4	45	110	250	-
	8 #16	20-7	80	110	250	280
	7 #16, 2 #12	20-16	80	110	250	280
	14 #16	20-27	35	110	250	325
	17 #16	20-29	80	-	-	280
	3 #12, 2 #8	20-14	80	110	250	280
	6 #16, 3 #12	20-18	35	110	250	325
	7 #12	20-15	80	-	-	280
22	3 #8	22-2	70	145	215	290
	4 #8	22-22	-	110	250	-
	1 #16, 4 #12	22-13	35	110	250	325
	4 #16, 2 #12	22-5	35	110	250	325
	8 #16	22-18	80	110	250	280
	6 #16, 3 #12	22-16	80	110	250	280
	14 #16	22-19	80	110	250	280
	19 #16	22-14	80	-	-	280
24	9 #16, 2 #12	24-20	80	110	250	280
	3 #16, 1 #0	24-4	80	110	250	280
	4 #8	24-22	45	110	250	-
	7 #8	24-10	80	-	-	280
	6 #12, 3 #8	24-11	35	110	250	325
	14 #16, 2 #12	24-7	80	110	250	280
	24 #16	24-28	80	110	250	280

Shell Size	No. of Contacts	Contact Arr.	W	X	Degrees Y	Z
28	6 #16, 6 #12	28-9	80	110	250	280
	12 #16	28-18	70	145	215	290
	12 #16, 2 #12	28-2	35	110	250	325
	15 #16	28-17	80	110	250	280
	18 #16, 4 #12	28-11	80	110	250	280
	26 #16	28-12	90	180	270	-
	35 #16	28-15	80	110	250	280
	37 #16	28-21	80	110	250	280
32	4 #4	32-71	45	110	250	-
	12 #16, 2 #4	32-9	80	110	250	280
	10 #16, 5 #12	32-12	80	110	250	280
	16 #16, 3 #8	32-6	80	110	250	280
	2 #12, 2 #4					
	18 #16, 5 #12	32-13	80	110	250	280
	28 #16, 7 #12	32-7	80	125	235	280
36	40 #16, 7 #12	36-7	80	110	250	280
	48 #16	36-10	80	125	235	280
	4 #0	36-5	-	120	240	-
	4 #4, 2 #0	36-6	35	110	250	325
	3 #12, 3 #0	36-3	70	145	215	290
	46 #16, 1 #12	36-8	80	110	250	280
	52 #16	36-52	72	144	216	288
40	24 #16, 6 #12	40-1	65	130	235	300

Dimensions shown in inches (mm)  
Specifications and dimensions subject to change

# MS/CV345\* MIL-C-5015 Rear Release Connectors

Circular  
A

## Wall Mounting Receptacle

MS3450

CV3450

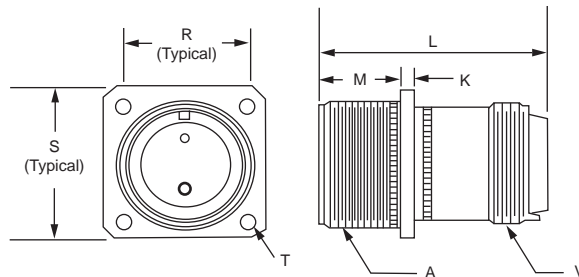

## Cable Connecting Receptacle

MS3451  
(Class L and W only)

CV3451

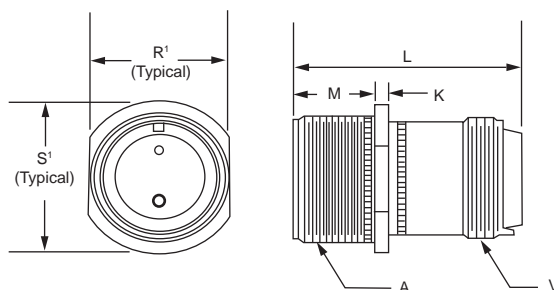
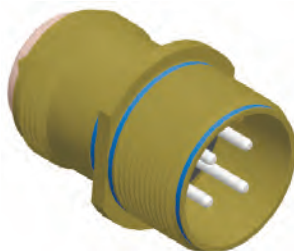

Shell Size	L Max.		K ±.015 (.38)	M +.031 (.79) -.000 (.00)	R ±.005 (.13)	R' Max.	S ±.031 (7.87)	S' ±.031 (7.87)	T Dia. +.015/-0.000 (+.38/-0.00)	
	Contact #16, #12, #8, #4	Contact #0							Class L, W, LS	Class KT, KS
8S	1.750 (44.45)	--	.053 (2.11)	.562 (14.27)	.594 (12.09)	.504 (12.20)	.875 (22.22)	.729 (18.52)	.115 (2.92)	.145 (3.68)
10S	1.750 (44.45)	--	.053 (2.11)	.562 (14.27)	.562 (14.27)	.629 (15.98)	1.000 (25.40)	.854 (21.69)	.115 (2.92)	.145 (3.68)
10SL	1.750 (44.45)	--	.053 (2.11)	.562 (14.27)	.719 (18.26)	.629 (15.98)	1.000 (25.40)	.854 (21.69)	.115 (2.92)	.145 (3.68)
12S	1.750 (44.45)	--	.053 (2.11)	.562 (14.27)	.812 (20.62)	.754 (19.15)	1.094 (27.79)	.974 (24.74)	.115 (2.92)	.145 (3.68)
12	2.100 (53.34)	--	.053 (2.11)	.750 (19.05)	.812 (20.62)	.754 (19.15)	1.094 (27.79)	.974 (24.74)	.115 (2.92)	.145 (3.68)
14S	1.750 (44.45)	--	.053 (2.11)	.562 (14.27)	.906 (23.01)	.879 (22.23)	1.188 (30.18)	1.099 (27.91)	.115 (2.92)	.145 (3.68)
14	2.100 (53.34)	--	.053 (2.11)	.750 (19.05)	.906 (23.01)	.879 (22.23)	1.188 (30.18)	1.099 (27.91)	.115 (2.92)	.145 (3.68)
16S	1.750 (44.45)	--	.053 (2.11)	.562 (14.27)	.969 (24.61)	1.005 (25.53)	1.281 (32.54)	1.224 (31.09)	.115 (2.92)	.145 (3.68)
16	2.100 (53.34)	--	.053 (2.11)	.750 (19.05)	.969 (24.61)	1.005 (25.53)	1.281 (32.54)	1.224 (31.09)	.115 (2.92)	.145 (3.68)
18	2.100 (53.34)	--	.125 (3.18)	.750 (19.05)	1.062 (26.97)	1.131 (28.73)	1.375 (34.92)	1.349 (34.26)	.115 (2.92)	.172 (4.37)
20	2.100 (53.34)	2.250 (57.15)	.125 (3.18)	.750 (19.05)	1.156 (29.36)	1.256 (31.90)	1.500 (38.10)	1.474 (37.44)	.115 (2.92)	.172 (4.37)
22	2.100 (53.34)	2.250 (57.15)	.125 (3.18)	.750 (19.05)	1.250 (31.75)	1.381 (35.08)	1.625 (41.28)	1.599 (40.61)	.115 (2.92)	.172 (4.37)
24	2.100 (53.34)	2.250 (57.15)	.125 (3.18)	.812 (20.62)	1.375 (34.92)	1.506 (38.25)	1.750 (44.45)	1.715 (43.56)	.142 (3.61)	.172 (4.37)
28	2.100 (53.34)	2.250 (57.15)	.125 (3.18)	.812 (20.62)	1.562 (39.67)	1.756 (44.60)	2.000 (50.80)	1.974 (50.14)	.142 (3.61)	.172 (4.37)
32	2.100 (53.34)	2.250 (57.15)	.125 (3.18)	.875 (22.22)	1.750 (44.45)	2.007 (50.98)	2.250 (57.18)	2.224 (56.18)	.168 (4.27)	.204 (5.18)
36	2.100 (53.34)	2.250 (57.15)	.125 (3.18)	.875 (22.22)	1.938 (49.23)	2.257 (57.33)	2.500 (63.50)	2.474 (56.36)	.168 (4.27)	.204 (5.18)
40	2.100 (53.34)	2.250 (57.15)	.125 (3.18)	.875 (22.22)	2.188 (55.56)	2.511 (63.78)	2.750 (69.85)	2.724 (69.19)	.168 (4.27)	.204 (5.18)
44	2.100 (53.34)	2.250 (57.15)	.125 (3.18)	.875 (22.22)	2.357 (60.32)	2.761 (70.13)	3.000 (76.20)	2.974 (75.54)	.168 (4.27)	.204 (5.18)
48	2.100 (53.34)	2.250 (57.15)	.125 (3.18)	.875 (22.22)	2.625 (66.68)	3.011 (76.48)	3.250 (82.55)	3.224 (81.89)	.168 (4.27)	.204 (5.18)

Shell Size	A Thread Class 2A	V Thread Class 2A
8S	1/2-28UNEF	1/2-20UNEF
10S	5/8-24UNEF	5/8-24UNEF
10SL	5/8-24UNEF	5/8-24UNEF
12S	3/4-20UNEF	3/4-20UNEF
12	3/4-20UNEF	3/4-20UNEF
14S	7/8-20UNEF	7/8-20UNEF
14	7/8-20UNEF	7/8-20UNEF
16S	1-20UNEF	1-20UNEF
16	1-20UNEF	1-20UNEF

Shell Size	A Thread Class 2A	V Thread Class 2A
18	1-1/8-18UNEF	1-1/16-18UNEF
20	1-1/4-18UNEF	1-3/16-18UNEF
22	1-3/8-18UNEF	1-5/16-18UNEF
24	1-1/2-18UNEF	1-7/16-18UNEF
28	1-3/4-18UNS	1-3/4-18UNS
32	2-UNS	2-UNS
36	2-1/4-16UN	2-1/4-16UN
40	2-1/2-16UN	2-1/2-16UN
44	2-3/4-16UN	2-3/4-16UN
48	3-16UN	3-16UN



Dimensions shown in inches (mm)  
Specifications and dimensions subject to change

www.ittcannon.com

Box Mounting Receptacle

CV3452

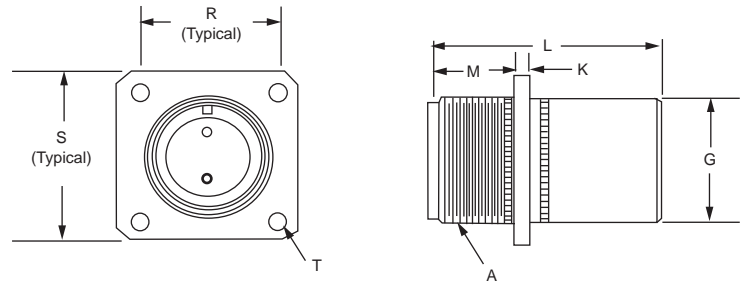

A

Circular

Shell Size	G Dia. ±.016 (0.41)	K ±.015 (0.38)	L Max.		M +.031 (.79) -.000 (.00)	R ±.005 (0.13)	S ±.031 (0.79)	T Dia. +.015/-0.000 (+.38/-0.00) Class L, W	A Thread Class 2A
			Contact #16 & #12	Contact #8, #4, & #0					
8S	.500 (12.70)	.083 (2.11)	.1662 (42.21)	--	.562 (14.27)	.594 (15.09)	.875 (22.22)	.115 (2.92)	1/2-28UNEF
10S	.625 (15.88)	.083 (2.11)	.1662 (42.21)	--	.562 (14.27)	.719 (18.26)	1.000 (25.40)	.115 (2.92)	5/8-24UNEF
10SL	.625 (15.88)	.083 (2.11)	.1662 (42.21)	--	.562 (14.27)	.719 (18.26)	1.000 (25.40)	.115 (2.92)	5/8-24UNEF
12S	.750 (19.05)	.083 (2.11)	.1662 (42.21)	--	.562 (14.27)	.812 (20.62)	1.094 (27.79)	.115 (2.92)	3/4-20UNEF
12	.750 (19.05)	.083 (2.11)	.1662 (42.21)	--	.750 (19.05)	.812 (20.62)	1.094 (27.79)	.115 (2.92)	3/4-20UNEF
14S	.875 (22.22)	.083 (2.11)	.1662 (42.21)	--	.562 (14.27)	.906 (23.01)	1.188 (30.18)	.115 (2.92)	7/8-20UNEF
14	.875 (22.22)	.083 (2.11)	.1662 (42.21)	--	.750 (19.05)	.906 (23.01)	1.188 (30.18)	.115 (2.92)	7/8-20UNEF
16S	1.000 (25.40)	.083 (2.11)	.1662 (42.21)	--	.562 (14.27)	.969 (24.61)	1.281 (32.54)	.115 (2.92)	1-20UNEF
16	1.000 (25.40)	.083 (2.11)	.1662 (42.21)	1.937 (49.20)	.750 (19.05)	.969 (24.61)	1.281 (32.54)	.115 (2.92)	1-20UNEF
18	1.062 (26.67)	.125 (3.18)	.1662 (42.21)	1.937 (49.20)	.750 (19.05)	1.062 (26.97)	1.375 (34.92)	.115 (2.92)	1-1/8-18UNEF
20	1.187 (30.15)	.125 (3.18)	.1662 (42.21)	1.937 (49.20)	.750 (19.05)	1.156 (29.36)	1.500 (38.10)	.115 (2.92)	1-1/4-18UNEF
22	1.312 (33.32)	.125 (3.18)	.1662 (42.21)	1.937 (49.20)	.750 (19.05)	1.250 (31.75)	1.625 (41.28)	.115 (2.92)	1-3/8-18UNEF
24	1.437 (36.50)	.125 (3.18)	.1662 (42.21)	1.937 (49.20)	.812 (20.62)	1.375 (34.92)	1.750 (44.45)	.142 (3.61)	1-1/2-18UNEF
28	1.750 (45.44)	.125 (3.18)	.1662 (42.21)	1.937 (49.20)	.812 (20.62)	1.562 (39.67)	2.000 (50.80)	.142 (3.61)	1-3/4-18UNS
32	2.000 (50.80)	.125 (3.18)	.1662 (42.21)	1.937 (49.20)	.875 (22.22)	1.750 (44.45)	2.250 (57.18)	.168 (4.27)	2-18UNS
36	2.250 (57.15)	.125 (3.18)	.1662 (42.21)	1.937 (49.20)	.875 (22.22)	1.938 (49.23)	2.500 (63.50)	.168 (4.27)	2-1/4-16UN
40	2.500 (63.50)	.125 (3.18)	.1662 (42.21)	1.937 (49.20)	.875 (22.22)	2.188 (55.58)	2.750 (69.85)	.168 (4.27)	2-1/2-16UN
44	2.750 (69.85)	.125 (3.18)	.1662 (42.21)	1.937 (49.20)	.875 (22.22)	2.375 (60.32)	3.000 (76.20)	.168 (4.27)	2-3/4-16UN
48	3.000 (76.20)	.125 (3.18)	.1662 (42.21)	1.937 (49.20)	.875 (22.22)	2.625 (66.68)	3.250 (82.55)	.168 (4.27)	3-16UN

Dimensions shown in inches (mm)  
Specifications and dimensions subject to change

www.ittcannon.com

# MS/CV345\* MIL-C-5015 Rear Release Connectors



A

Circular

MS3456

CV3456

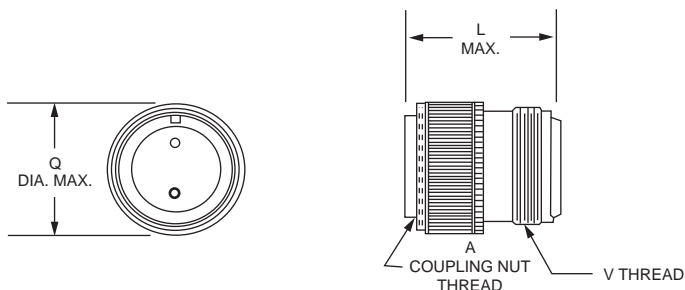

Shell Size	L Max.		Q Dia. Max.	A Thread Class 2B	V Thread Class 2A
	Contact #16, #12, #8, #4	Contact #0			
8S	1.750 (44.45)	--	.844 (21.44)	1/2-28UNEF	1/2-20UNEF
10S	1.750 (44.45)	--	.969 (24.61)	5/8-24UNEF	5/8-24UNEF
10SL	1.750 (44.45)	--	.969 (24.61)	5/8-24UNEF	5/8-24UNEF
12S	1.750 (44.45)	--	1.062 (26.97)	3/4-20UNEF	3/4-20UNEF
12	2.100 (53.34)	--	1.062 (26.97)	3/4-20UNEF	3/4-20UNEF
14S	1.750 (44.45)	--	1.156 (29.36)	7/8-20UNEF	7/8-20UNEF
14	2.100 (53.34)	--	1.156 (29.36)	7/8-20UNEF	7/8-20UNEF
16S	1.750 (44.45)	--	1.250 (31.75)	1-20UNEF	1-20UNEF
16	2.100 (53.34)	--	1.250 (31.75)	1-20UNEF	1-20UNEF

Shell Size	L Max.		Q Dia. Max.	A Thread Class 2B	V Thread Class 2A
	Contact #16, #12, #8, #4	Contact #0			
18	2.100 (53.34)	--	1.344 (34.14)	1-1/8-18UNEF	1-1/16-18UNEF
20	2.100 (53.34)	2.250 (57.15)	1.469 (37.31)	1-1/4-18UNEF	1-3/16-18UNEF
22	2.100 (53.34)	2.250 (57.15)	1.594 (40.49)	1-3/8-18UNEF	1-5/16-18UNEF
24	2.100 (53.34)	2.250 (57.15)	1.719 (43.66)	1-1/2-18UNEF	1-7/16-18UNEF
28	2.100 (53.34)	2.250 (57.15)	1.969 (50.01)	1-3/4-18UNS	1-3/4-18UNS
32	2.100 (53.34)	2.250 (57.15)	2.219 (56.36)	2-18UNS	2-18UNS
36	2.100 (53.34)	2.250 (57.15)	2.469 (62.71)	2-1/4-16UN	2-1/4-16UN
40	2.100 (53.34)	2.250 (57.15)	2.719 (69.06)	2-1/2-16UN	2-1/2-16UN
44	2.100 (53.34)	2.250 (57.15)	2.969 (75.41)	2-3/4-16UN	2-3/4-16UN
48	2.100 (53.34)	2.250 (57.15)	3.219 (81.76)	3-16UN	3-16UN

## Cable Connecting Plug

MS3459

CV3459

Self-Locking Coupling Nut

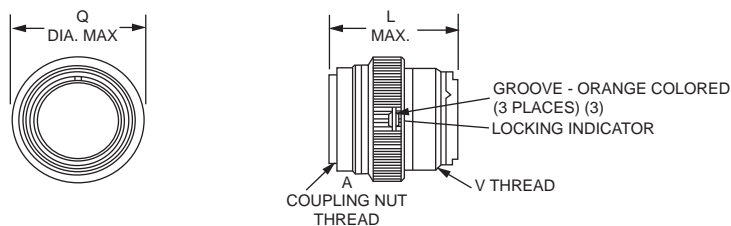
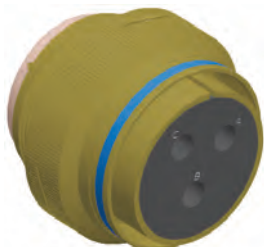

Shell Size	L Max.		Q Dia. Max.	A Thread Class 2B	V Thread Class 2A
	Contact #16, #12, #8, #4	Contact #0			
8S	1.750 (44.45)	--	.963 (24.46)	1/2-28UNEF	1/2-20UNEF
10S	1.750 (44.45)	--	1.088 (27.64)	5/8-24UNEF	5/8-24UNEF
10SL	1.750 (44.45)	--	1.088 (27.64)	5/8-24UNEF	5/8-24UNEF
12S	1.750 (44.45)	--	1.213 (30.8)	3/4-20UNEF	3/4-20UNEF
12	2.100 (53.34)	--	1.213 (30.8)	3/4-20UNEF	3/4-20UNEF
14S	1.750 (44.45)	--	1.358 (34.49)	7/8-20UNEF	7/8-20UNEF
14	2.100 (53.34)	--	1.358 (34.49)	7/8-20UNEF	7/8-20UNEF
16S	1.750 (44.45)	--	1.463 (37.16)	1-20UNEF	1-20UNEF

Shell Size	L Max.		Q Dia. Max.	A Thread Class 2B	V Thread Class 2A
	Contact #16, #12, #8, #4	Contact #0			
16	2.100 (53.34)	--	1.463 (37.16)	1-20UNEF	1-20UNEF
18	2.100 (53.34)	--	1.588 (40.34)	1-1/8-18UNEF	1-1/16-18UNEF
20	2.100 (53.34)	2.250 (57.15)	1.713 (43.51)	1-1/4-18UNEF	1-3/16-18UNEF
22	2.100 (53.34)	2.250 (57.15)	1.788 (45.42)	1-3/8-18UNEF	1-5/16-18UNEF
24	2.100 (53.34)	2.250 (57.15)	1.963 (49.86)	1-1/2-18UNEF	1-7/16-18UNEF
28	2.100 (53.34)	2.250 (57.15)	2.213 (56.21)	1-3/4-18UNS	1-3/4-18UNS
32	2.100 (53.34)	2.250 (57.15)	2.463 (62.56)	2-18UNS	2-18UNS
36	2.100 (53.34)	2.250 (57.15)	2.713 (68.91)	2-1/4-16UN	2-1/4-16UN
40	2.100 (53.34)	2.250 (57.15)	2.963 (75.26)	2-1/2-16UN	2-1/2-16UN



Dimensions shown in inches (mm)  
Specifications and dimensions subject to change

www.ittcannon.com



A

Circular

Contact Arrangements

Face view, Pin insert

Shell Size	8S-1	10S-2	10SL-4	10SL-3	12-5	12S-3	14S-9	14S-7
No. of Contacts	1 #16	1 #16	2 #16	3 #16	1 #12	2 #16	2 #16	3 #16
Service Rating	A	A	A	A	D	A	A	A

Shell Size	14S-2	14S-5	14S-6	16S-4	16-11	16-7	16-10	16-9
No. of Contacts	4 #16	5 #16	6 #16	2 #16	2 #12	2 #16 (A,B) 1 #8 (C)	3 #12 (A-C)	2 #16 (B,D) 2 #12 (A,C)
Service Rating	Inst.	Inst.	Inst.	D	A	A	A	A

Socket Only

Shell Size	16S-8	16S-1	18-22	18-4	18-10	18-11	18-12	18-9
No. of Contacts	5 #16	7 #16	3 #16	4 #16	4 #12	5 #12	6 #16	5 #16 (B,C,E-G) 2 #12 (A,D)
Service Rating	A	A	D	D	A	A	A	Inst.
					For new MIL equip. design, use 18-11		For new MIL equip. design, use 16S-1	

Shell Size	18-8	18-1	20-2	20-4	20-14	20-15	20-7	20-16
No. of Contacts	7 #16 (A-G) 1 #12 (H)	10 #16	1 #0	4 #12	3 #12 (C,D,E) 2 #8 (A,B)	7 #12	8 #16	7 #16 (A-G) 2 #12 (H,I)
Service Rating	A	A (B, C, F, G) Inst. (all others)	D	D	A	A	A (C-F) D (A,B,G,H)	A

Pin Only

Shell Size	20-18	20-27	20-29	22-2	22-22	22-13	22-5	22-18
No. of Contacts	6 #16 (A,C-E,G,H) 3 #12 (B,F,I)	14 #16	17 #16	3 #8	4 #8	1 #16 (E) 4 #12 (A-D)	4 #16 (A,C,D,F) 2 #12 (B,E)	8 #16
Service Rating	A	A	A	D	A	A (A-D), D (E)	D	A (C-E) D (all others)

Socket Only

Shell Size	22-16	22-19	22-14	24-4	24-22	24-10	24-11	24-20
No. of Contacts	6 #16 (A,B,F,J) 3 #12 (C-E)	14 #16	19 #16	3 #16 (B,C,D) 1 #0 (A)	4 #8	7 #8	6 #12 (A-C,G-I) 3 #8 (D-F)	9 #16 (A-D,G-L) 2 #12 (E-F)
Service Rating	A	A	A	D	D	A	A	D

Dimensions shown in inches (mm)  
Specifications and dimensions subject to change

MS/CV345\*  
MIL-C-5015 Rear Release Connectors

Contact Arrangements

Face view, Pin insert

A

Circular

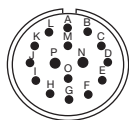

24-7  
14 #16(A-M, O)  
2 #12(P, N)  
A

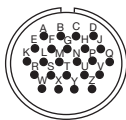

24-28  
24 #16  
Inst.

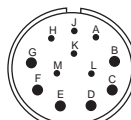

28-9  
6 #16(A, H-M)  
6 #12(B-G)  
D

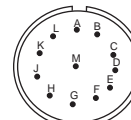

28-18  
12 #16  
A (A, B) C (M)  
D (G-L)  
Inst. (C-F)

Shell Size  
No. of Contacts  
Service Rating

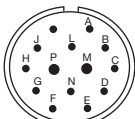

28-2  
12 #16(A, L, N)  
2 #12(M, P)  
D

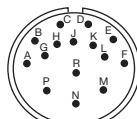

28-17  
15 #16  
A(A-L), B(R), D(M-P)

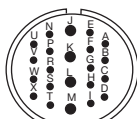

28-11  
18 #16(A-I, N-X)  
4 #12(J-M)  
A

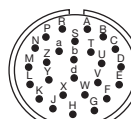

28-12  
26 #16  
A

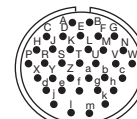

28-15  
35 #16  
A  
For MIL equip  
design, use 28-21

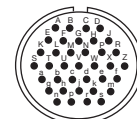

28-21  
37 #16  
A

Shell Size  
No. of Contacts  
Service Rating

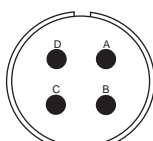

32-17  
4 #4  
D

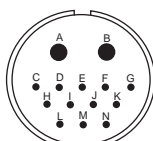

32-9  
12 #16(C-N)  
2 #4(A, B)  
D

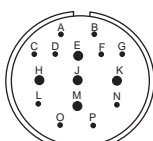

32-12  
10 #16(A-D, F, G, L, N-P)  
5 #12(E, H, J, K, M)  
A (C-G), D (all others)

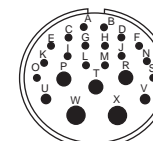

32-6  
16 #16(A-O, S) 2 #12(U, V)  
3 #8(P, R, T) 2 #4(W, X)  
A

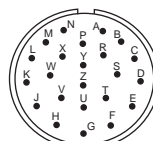

32-13  
18 #16(A-D, K-Z)  
5 #12(E-J)  
D

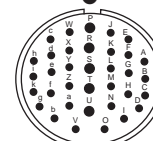

32-7  
28 #16(A-N, W-Z, a-k)  
7 #12(O-V)  
Inst. (A, B, h, i)  
A (all others)

Shell Size  
No. of Contacts  
Service Rating

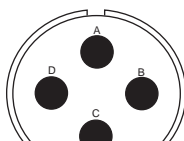

36-5  
4 #10  
36-5  
4 #5

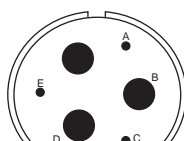

36-3  
3 #12(A, C, E)  
3 #0(B, D, F)  
D

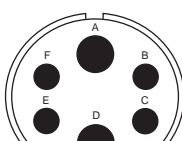

36-6  
4 #4(B, C, E, F)  
2 #0(A, D)  
A

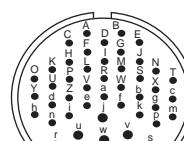

36-7  
40 #16(A-Z, a-s)  
7 #12(t-z)  
A

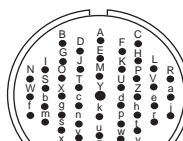

36-8  
46 #16(A-X, Z-z)  
1 #12(Y)  
A

Shell Size  
No. of Contacts  
Service Rating

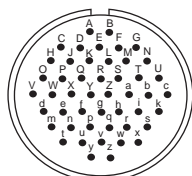

36-10  
48 #16  
A

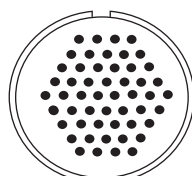

36-52  
52 #16  
A

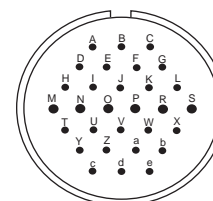

40-1  
24 #16(A-L, T-e)  
6 #12(M-S)  
D

Shell Size  
No. of Contacts  
Service Rating



Dimensions shown in inches (mm)  
Specifications and dimensions subject to change

www.ittcannon.com





A

Circular

## Contacts



### Pin, MIL-C-39029/29

BIN Code	Military Part Number	Color Bands			Mating End Size	Wire Barrel Size	ITT Cannon Part Number
		1st	2nd	3rd			
212	M39029/29-212	Red	Brown	Red	16	16	980-0009-501
213	M39029/29-213	Red	Brown	Orange	12	12	980-0009-502
214	M39029/29-214	Red	Brown	Yellow	8	8	980-0009-503
215	M39029/29-215	Red	Brown	Green	4	4	980-0009-504
216	M39029/29-216	Red	Brown	Blue	0	0	980-0009-505

### Socket, MIL-C-39029/30

BIN Code	Military Part Number	Color Bands			Mating End Size	Wire Barrel Size	ITT Cannon Part Number
		1st	2nd	3rd			
217	M39029/30-217	Red	Brown	Violet	16S	16	980-0009-495
218	M39029/30-218	Red	Brown	Gray	16	16	980-0009-496
219	M39029/30-219	Red	Brown	White	12	12	980-0009-497
220	M39029/30-220	Red	Red	Black	8	8	980-0009-498
221	M39029/30-221	Red	Red	Brown	4	4	980-0009-452
222	M39029/30-222	Red	Red	Red	0	0	980-0009-500

### Wire Hole Fillers

Contact Size	ITT Cannon Part Number	Part Number	Color Code
16	225-0071-000	MS27488-16-3	Blue
12	225-0072-000	MS27488-12-3	Yellow
*8	225-1009-000	MS27488-8-3	Red
*4	225-1008-000	MS27488-4-3	Blue
*0	225-1007-000	MS27488-0-3	Yellow

\* Consult factory for availability

### Thermocouple

Contact Size	Alumel			Chromel	
	Pin	Socket		Pin	Socket
16S*	030-3196-015	031-3113-011		030-3196-016	031-3113-012
16	030-3196-015	031-3114-014		030-3196-016	031-3114-015
12	030-3197-011	031-3115-009		030-3197-012	031-3115-010

\* 16S type socket contacts are for use in 8S, 10S, 10SL, 12S, 14S, and 16S shell size connectors.

## Tooling

A complete line of crimp, insertion and extraction tools is provided for MIL-C-5015 connectors. Crimp tools are made from high quality metal and are designed for long life and trouble-free service. Insertion and extraction tools are made of a durable plastic and are inexpensive and expendable.

Contact Size	Insertion/Extraction Tools							
	MS No.	Plastic Part Number	ITT Cannon No.	MS No.	ITT Cannon No.	Crimp Tool	Unwired Contact	
16	M8 1969/14-03	274-7002-000	CIET-16-03	-	-	M22520/01 with M22520/1-02 Turret	274-7008-000	
12	M8 1969/14-04	274-7003-000	CIET-12-04	-	-	CBT 520/530	274-7009-000	
8	MS3165-8 M83723/32-8		CET 8-2	MS3483-1	CET-CVR-8	CBT 600B Power Unit CCH-8-1 Crimp Head CCHP-8-6 Locator	- - -	
4	MS3165-4 M83723/32-4		CET 4-8	MS3483-2	CET-CVR-4	CBT 600B Power Unit CCH-4-1 Crimp Head CCHP-4-8 Locator	- - -	
0	MS3165-0 M83723/32-0		CET 0-1	MS3483-3	CET-00-CV	CBT 600B Power Unit CCH-0-1 Crimp Head CCHP-0-8 Locator	- - -	

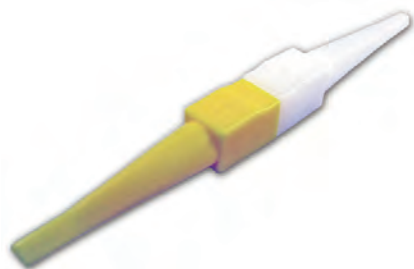

CIET-16



CBT-520/530



M22520/1-01

Dimensions shown in inches (mm)  
Specifications and dimensions subject to change

www.ittcannon.com

