

- Interchangeable with MIL-C-26482 Series 1
- Operating temperature - 55°C to + 200°C

The PV connector is designed to meet the rugged requirements of MIL-C-26482, Series 2/MIL-C-83723 Series 1\*, the specification which delineates the critical requirements of space-age applications. PV connectors have been used extensively on major aerospace programs requiring general-purpose, miniature cylindrical bayonet coupling connectors such as Space Shuttle, Apollo, ATM, OWS Minuteman, Skylab, Thor-Delta, Titan IIIC, and Viking.

The PV series is an important member of the Universal Interconnect System (UIS) - the only system that can perform all interconnection missions. This system is adaptable for use with connectors of all shapes and sizes, including circular and rectangular configurations, standard, miniature and subminiature sizes. UIS is a rear servicing system that evolved from the LITTLE CAESAR® rear release contact retention assembly, pioneered and developed by ITT Cannon. Since this time, ITT Cannon, and its licensees, have supplied to industry over 250 million interconnections utilizing this system.

PV7 connectors are available under numerous industrial specifications, some of which are listed below:

- CS512089 Jet Propulsion Laboratory
- 40M39569 NASA, George C. Marshall Space Flight Center
- 81D52 Martin Marietta, Denver Division
- MG414-0365 Rockwell International Space Division
- AC414-0013 Rockwell International Autonetics Division
- STS0003 McDonnell Douglas Astronautics

This connector series is manufactured to accommodate the following backshells: M85049/31 (MS3416), M85049/51 (MS3418) and M85049/52 (MS3417). Backshells are not included with connector and must be ordered separately. Backshells on page 161 are Non-MS type.

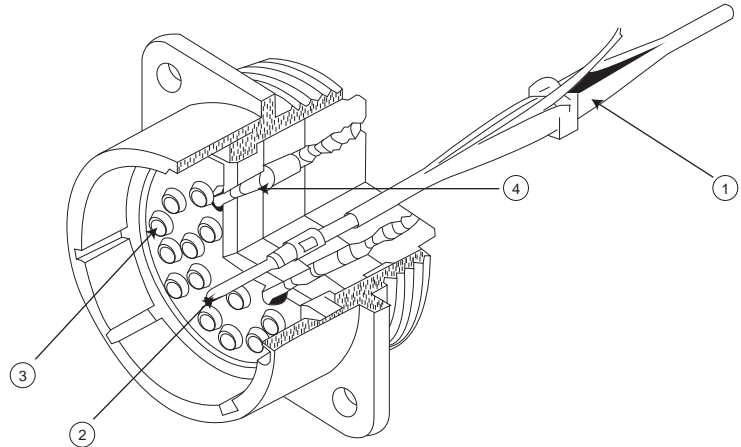

**Universal Insertion / Extraction Tool Style** - A single, expendable plastic tool is used for insertion and extraction of both pins and sockets.

**Simple, Strong Contact Design** - One basic configuration eliminates undercuts and maximizes bend resistance for positive contact mating.

**Closed-Entry Socket Insert** - Hard dielectric socket face of mating connector has lead-in chamfers for positive alignment of pins and sockets.



**Interfacial Pin Insert Seal** - Universal interconnect permits design of raised moisture barriers around each pin which mate into lead-in chambers of hard face sockets insert for individual contact sealing. Interfacial sealing is never touched by service tools.

**Superior Contact Stability** - Rear Contact Release System (LITTLE CAESAR contact assembly) features a stamped metal retaining clip captivated by molded-in shoulders of each contact cavity in the insulator. A rear-inserted plastic tool expands the tines beyond the contact shoulder, releasing the contact.

**Polarized Backshells** - Interlocking teeth on the front of the backshell and rear portion of the shell allow endbells to be positioned as desired, eliminating chafing of wire during assembly.

## Military Specification Cross Reference

PV7 and MIL-C-26482 (Series 2) Replacement for	MS Standards	ITT Cannon Prefix	MIL-C-83723*		Description
		Commercial Design	Socket	Pin	
<b>MIL-C-26482 (Series 1)</b>		<b>MIL-C-26482</b>	<b>Socket</b>	<b>Pin</b>	
MS3110,MS3120	MS3470	PV70	/1	/2	Narrow Flange Receptacle
MS3111,MS3121	MS3471	PV71	/7	/8	Cable Connecting Receptacle
MS3112,MS3122	MS3470	PV70	/1	/12	Narrow Flange Receptacle
MS3114,MS3124	MS3474	PV74	/5	/6	Jam Nut Receptacle
MS3116,MS3126	MS3476	PV76	/13	/14	Straight Plug
	MS3472	PV72	/3	/4	Wide Flange Receptacle
	MS3475	PV75	/43	/42	Straight Plug, RFI Shielded
<b>NAS1599</b>					
NAS1650,NAS1699	MS3470		/1	/2	Narrow Flange Receptacle
NAS1651,NAS1700	MS3472		/3	/4	Wide Flange Receptacle
NAS1652,NAS1701	MS3474		/5	/6	Jam Nut Receptacle
NAS1653,NAS1702	MS3476		/13	/14	Straight Plug

\*NOTE: M83723 series has been superseded by MIL-C-26482 Series 2.

## Performance and Material Specifications

### MATERIALS AND FINISHES

Description	Material	Finish
Shell	Aluminum alloy per QQ-A-367, QQ-A-591 or QQ-A-225	Electroless nickel per MIL-C-26074, anodized per MIL-A-8625 or olive drab cadmium over nickel
Insulators	Rigid dielectric	None
Elastomers (grommets, interfacial and O ring seals)	Silicone rubber (ITT Cannon blend) or Fluorosilicone rubber (ITT Cannon blen)	None None
Contacts	Copper alloy	Gold page per MIL-G-45204
Coupling Nut	Aluminum alloy per QQ-A-591	Electroless nickel per MIL-C-26074, anodized per MIL-A-8625 or olive drab cadmium over nickel
Jam Nut (on PV74)	Aluminum alloy per QQ-A-225	Electroless nickel per MIL-C-26074, anodized per MIL-A-8625 or olive drab cadmium over nickel

### ELECTRICAL

Contact Size	Wire Size	Insulation O.D. Limits, inch (mm)		Max Current for Test (amps)	Potential Drop (Millivolts at 25°C)
		min.	max.		
12	12	.097 (2.46)	.158 (4.01)	23	50
	14				
16	16	.053 (1.53)	.103 (2.62)	13	50
	20				
20	20	.040 (1.02)	.083 (2.11)	7.5	55
	24				

Service Rating	Dielectric Withstanding Voltage (Test Volatge)		
	Sea Level	70,000 ft. Altitude	(25°C)
I	1500 Vac rms	375 Vac rms	5000 megohms minimum
II	2300 Vac rms	500 Vac rms	5000 megohms minimum

### How to Order

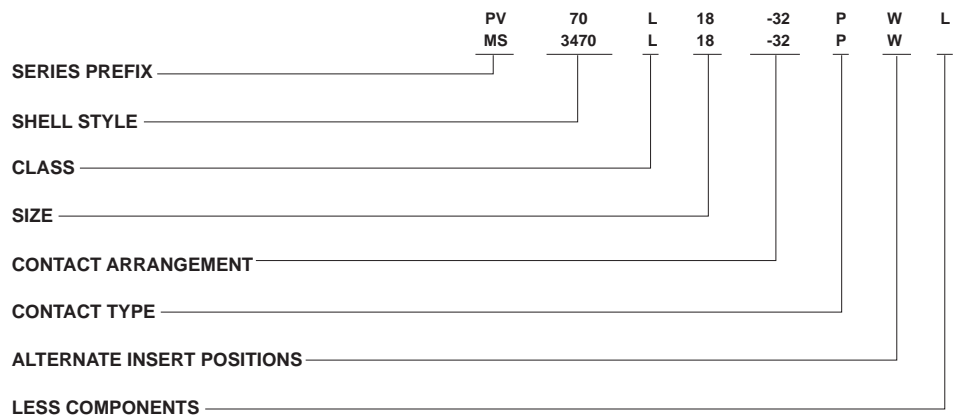

#### SERIES PREFIX

MS - Complies with MIL-C-26482 Series 2  
 PV - ITT Cannon Interchangeable with MIL-C-26482, Series 2

#### SHELL STYLE

ITT Cannon Part No.	Military No.	Description
PV70	MS3470	- Narrow Flange Receptacle
PV71	MS3471	- Cable Connecting Receptacle
PV72	MS3472	- Wide Flange Receptacle
PV74	MS3474	- Jam Nut Receptacle
PV75	MS3475	- Straight Plug, RFI Shielded
PV76	MS3476	- Straight Plug

#### CLASS

(PV Series and MS Series)  
 \*A - Fluid resistant, 200°C, non-conductive (anodized)  
 L - Fluid resistant, 200°C, conductive, finish (nickely)  
 W - Corrosive and fluid resistant, 175°C (cadmium over nickel)

#### SHELL SIZE

8, 10, 12, 14, 16, 18, 20, 22 and 24  
 (Size 8 available in PV70 & 76 only)

#### CONTACT ARRANGEMENTS

See page 162.

#### CONTACT TYPE

P - Pin contact  
 S - Socket contact  
 A - Less pin contact\* (MS only)  
 B - Less socket contacts\* (MS only)  
 \* The "A" and "B" designators are used only when other than power contacts are ato be installed (i.e. shielded, coaxial and thermocouple contacts).

#### ALTERNATE INSERT POSITIONS

No designation required for normal position.  
 Standard MS alternate positions available.

#### LESS COMPONENTS

Use "L" if PV connectors are ordered less contacts, sealing plugs and insertion/extraction tool ("L" is not stamped on connectors). To order MS connectors less contacts, purchase order must state less contacts.

\*Consult factory for availability.

## Narrow Flange Receptacle

MS3470

PV70

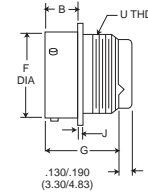
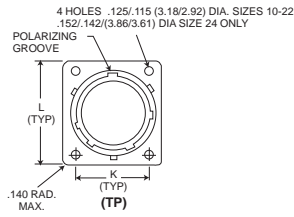

Shell Size*	B Max	F Max	G Max	J Max	K	L	U Thread UNEF Class 2A
8	.462 (11.73)	.474 (12.04)	1.215 (30.85)	.078 (1.98)	.594 (15.09)	.828 (21.03)	1/2-20
10	.462 (11.73)	.594 (15.01)	1.215 (30.85)	.078 (1.98)	.719 (18.26)	.954 (24.23)	5/8-24
12	.462 (11.73)	.751 (19.08)	1.215 (30.85)	.078 (1.98)	.812 (20.62)	1.047 (26.59)	3/4-20
14	.462 (11.73)	.876 (22.25)	1.215 (30.85)	.078 (1.98)	.906 (23.01)	1.141 (28.98)	7/8-20
16	.462 (11.73)	1.001 (25.43)	1.215 (30.85)	.078 (1.98)	.969 (24.61)	1.234 (31.34)	1-20
18	.462 (11.73)	1.126 (28.60)	1.215 (30.85)	.078 (1.98)	1.062 (26.97)	1.328 (33.73)	1-1/16-18
20	.587 (14.91)	1.251 (31.78)	1.275 (32.40)	.110 (2.79)	1.156 (29.36)	1.453 (36.91)	1-3/16-18
22	.587 (14.91)	1.376 (34.95)	1.275 (32.40)	.110 (2.79)	1.250 (31.75)	1.578 (40.08)	1-5/16-18
24	.620 (15.75)	1.501 (38.13)	1.275 (32.40)	.110 (2.79)	1.375 (34.93)	1.703 (43.26)	1-7/16-18

## Cable Connecting Receptacle

MS3471

PV71

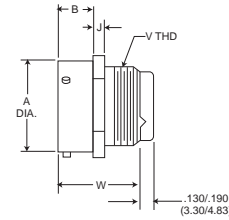
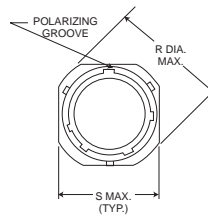

Shell Size*	A Max	B Max	J Max	R Dia. Max	S Max	W Max	U Thread UNEF Class 2A
10	.591 (15.01)	.462 (11.73)	.078 (1.98)	1.082 (27.48)	.954 (24.23)	1.215 (30.86)	5/8-24
12	.751 (19.08)	.462 (11.73)	.078 (1.98)	1.176 (29.87)	1.047 (26.59)	1.215 (30.86)	3/4-20
14	.876 (22.25)	.462 (11.73)	.078 (1.98)	1.270 (32.26)	1.141 (28.98)	1.215 (30.86)	7/8-20
16	1.001 (25.43)	.462 (11.73)	.078 (1.98)	1.364 (34.64)	1.234 (31.34)	1.215 (30.86)	1-20
18	1.126 (28.60)	.462 (11.73)	.078 (1.98)	1.458 (37.03)	1.328 (33.73)	1.215 (30.86)	1-1/16-18
20	1.251 (31.78)	.587 (14.91)	.110 (2.79)	1.708 (43.38)	1.578 (40.08)	1.275 (32.38)	1-5/16-18
22	1.376 (34.95)	.587 (14.91)	.110 (2.79)	1.708 (43.38)	1.578 (40.08)	1.275 (32.38)	1-5/16-18
24	1.501 (38.13)	.620 (15.75)	.110 (2.79)	1.832 (46.53)	1.703 (43.26)	1.275 (32.38)	1-7/16-18

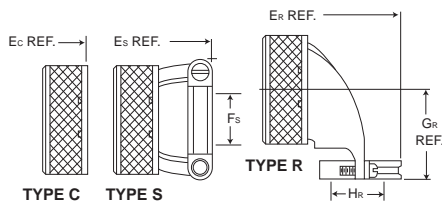

Backshell Assemblies not supplied with MS connectors.

Performance Specifications - Page 158

Contacts, Sealing Plugs, Assembly Tools - Pages 163, 165

Contacts Arrangements - Page 162

### Receptacle Assembly With Backshell†

Shell Size*	TYPE C		TYPE S		TYPE R		
	Ec Max.	Fs Max.	Es Max.	Gr Max.	Hr Max.	Er Max.	
10	1.492 (37.90)	.286 (7.26)	1.842 (46.79)	.880 (23.35)	.286 (7.26)	2.115 (53.72)	
12	1.492 (37.90)	.416 (10.57)	1.842 (46.79)	.950 (24.13)	.416 (10.57)	2.250 (57.15)	
14	1.492 (37.90)	.476 (12.09)	2.077 (52.76)	1.010 (25.65)	.476 (12.09)	2.340 (59.44)	
16	1.492 (37.90)	.626 (15.90)	2.077 (52.76)	1.070 (27.18)	.626 (15.90)	2.475 (62.87)	
18	1.492 (37.90)	.706 (17.93)	2.077 (52.76)	1.130 (28.70)	.706 (17.93)	2.574 (65.38)	
20	1.552 (39.42)	.831 (21.11)	2.137 (54.28)	1.190 (30.23)	.831 (21.11)	2.767 (70.28)	
22	1.552 (39.42)	.956 (24.28)	2.137 (54.28)	1.260 (32.00)	.956 (24.28)	2.890 (73.41)	
24	1.552 (39.42)	1.081 (27.46)	2.137 (54.28)	1.320 (33.53)	1.081 (27.46)	3.012 (76.50)	

\*See page 158 for part numbers.† To order backshell assemblies separately, see page 161.

## Wide Flange Receptacle

MS3472

PV72

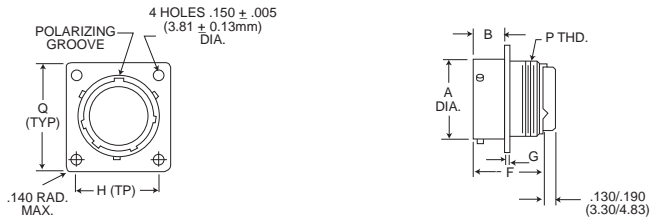

Shell Size*	A Max.	B Max.	F Max.	G Max.	H Max.	Q Max.	P Thread UNEF Class A
10	.591 (15.01)	.493 (12.52)	1.215 (30.85)	.078 (1.98)	.812 (20.62)	1.141 (28.98)	5/8-24
12	.751 (19.08)	.493 (12.52)	1.215 (30.85)	.078 (1.98)	.938 (23.83)	1.266 (32.16)	3/4-20
14	.876 (22.25)	.493 (12.52)	1.215 (30.85)	.078 (1.98)	1.031 (26.19)	1.360 (34.54)	7/8-20
16	1.001 (25.43)	.493 (12.52)	1.215 (30.85)	.078 (1.98)	1.125 (28.58)	1.453 (36.91)	1-20
18	1.126 (28.60)	.493 (12.52)	1.215 (30.85)	.078 (1.98)	1.203 (30.56)	1.532 (38.91)	1-1/16-18
20	1.251 (31.78)	.587 (14.91)	1.275 (32.40)	.110 (1.98)	1.297 (32.94)	1.688 (42.88)	1-3/16-18
22	1.376 (34.95)	.587 (14.91)	1.275 (32.40)	.110 (1.98)	1.375 (34.93)	1.766 (44.86)	1-5/16-18
24	1.501 (38.13)	.620 (15.75)	1.275 (32.40)	.110 (1.98)	1.500 (38.10)	1.891 (48.03)	1-7/16-18

## Jam Nut Receptacle

MS3474

PV74

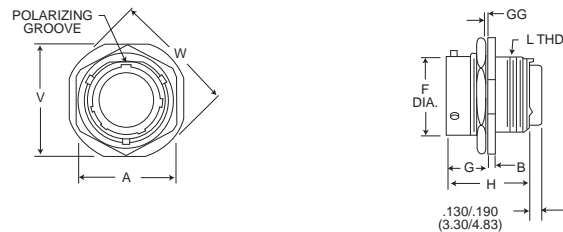

Shell Size*	V Max.	A Max.	B Max.	F Max.	G Max.	GG Panel Thickness	H Max.	W Dia. Max.	L Thread UNEF Class 2
8	.954 (24.23)	.767 (19.48)	.113 (2.87)	.474 (12.04)	.707 (17.96)	.187/.062 (4.75/1.57)	1.215 (30.86)	1.078 (27.38)	1/2-20
10	1.078 (27.38)	.892 (22.66)	.113 (2.87)	.591 (15.01)	.707 (17.96)	.187/.062 (4.75/1.57)	1.215 (30.85)	1.203 (30.56)	5/8-24
12	1.266 (32.16)	1.079 (27.41)	.113 (2.87)	.751 (19.08)	.707 (17.96)	.187/.062 (4.75/1.57)	1.215 (30.85)	1.391 (35.33)	3/4-20
14	1.391 (35.33)	1.205 (30.61)	.113 (2.87)	.876 (22.25)	.707 (17.96)	.187/.062 (4.75/1.57)	1.215 (30.85)	1.516 (38.51)	7/8-20
16	1.516 (38.51)	1.329 (33.76)	.113 (2.87)	1.001 (25.43)	.707 (17.96)	.187/.062 (4.75/1.57)	1.215 (30.85)	1.641 (41.68)	1-20
18	1.641 (41.68)	1.455 (36.96)	.113 (2.87)	1.126 (28.60)	.707 (17.96)	.187/.062 (4.75/1.57)	1.215 (30.85)	1.766 (44.86)	1-1/16-18
20	1.828 (46.43)	1.579 (40.11)	.148 (3.76)	1.251 (31.78)	.772 (19.61)	.250/.062 (6.35/1.57)	1.275 (32.40)	1.954 (49.63)	1-3/16-18
22	1.954 (49.63)	1.705 (40.11)	.148 (3.76)	1.376 (34.95)	.772 (19.61)	.250/.062 (6.35/1.57)	1.275 (32.40)	2.078 (52.78)	1-5/16-18
24	2.078 (52.78)	1.829 (46.46)	.148 (3.76)	1.501 (38.13)	.772 (19.61)	.219/.062 (5.56/1.57)	1.275 (32.40)	2.203 (55.96)	1-7/16-18

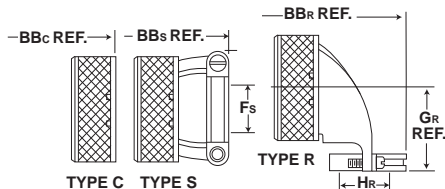

Backshell Assemblies not supplied with MS connectors.

Performance Specifications - Page 158

Contacts, Sealing Plugs, Assembly Tools - Pages 163, 165

Contact Arrangements - Page 162

### Receptacle Assembly With Backshell†

Shell Size*	TYPE C			TYPE S		TYPE R	
	BBc Max.	BBs Max.	Fs Max.	BBr Max.	Gr Max.	Hr Max.	
10	1.492 (37.90)	1.842 (46.79)	.286 (7.26)	2.115 (53.72)	.880 (22.35)	.286 (7.26)	
12	1.492 (37.90)	1.842 (46.79)	.416 (10.57)	2.250 (57.15)	.950 (24.13)	.416 (10.57)	
14	1.492 (37.90)	2.077 (52.76)	.476 (12.09)	2.340 (59.44)	1.010 (25.65)	.476 (12.09)	
16	1.492 (37.90)	2.077 (52.76)	.626 (15.90)	2.475 (62.87)	1.070 (27.18)	.626 (15.90)	
18	1.492 (37.90)	2.077 (52.76)	.706 (17.93)	2.574 (65.38)	1.130 (28.70)	.706 (17.93)	
20	1.552 (39.42)	2.137 (54.28)	.831 (21.11)	2.767 (70.28)	1.190 (30.23)	.831 (21.11)	
22	1.552 (39.42)	2.137 (54.28)	.956 (24.28)	2.890 (73.41)	1.260 (32.00)	.956 (24.28)	
24	1.552 (39.42)	2.137 (54.28)	1.081 (27.46)	3.012 (76.50)	1.320 (33.53)	1.081 (27.46)	

\* See page 158 for part numbers. † To order backshell assemblies separately, see page 161.

## Straight Plug

MS3476

PV76

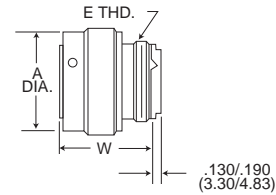
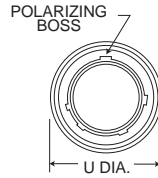

Shell Size*	A Dia. Max.	U Max.	W Max.	E Thread UNEF Class 2A
8	.765 (19.43)	.782 (19.86)	1.230 (31.24)	1/2-20
10	.840 (21.34)	.926 (23.52)	1.230 (31.24)	5/8-24
12	.999 (25.37)	1.043 (26.49)	1.230 (31.24)	3/4-20
14	1.139 (28.93)	1.183 (30.05)	1.230 (31.24)	7/8-20
16	1.261 (32.03)	1.305 (33.15)	1.230 (31.24)	1-20
18	1.337 (33.96)	1.391 (35.33)	1.230 (31.24)	1-1/16-18
20	1.477 (37.52)	1.531 (38.89)	1.230 (31.24)	1-3/16-18
22	1.602 (40.69)	1.656 (42.06)	1.230 (31.24)	1-5/16-18
24	1.723 (43.76)	1.777 (45.14)	1.230 (31.24)	1-7/16-18

MS34745

PV75

Straight Plug, RFI Shielded



Shell Size*	E Thread UNEF Class 2A	A Dia. Max.	U Max.	W Max.
10	5/8-24	.840 (21.34)	.926 (21.72)	1.230 (31.24)
12	3/4-20	.999 (25.37)	1.043 (26.42)	1.230 (31.24)
14	7/8-20	1.139 (28.93)	1.183 (29.97)	1.230 (31.24)
16	1-20	1.261 (32.03)	1.305 (33.15)	1.230 (31.24)
18	1-1/16-18	1.337 (33.96)	1.391 (35.33)	1.230 (31.24)
20	1-3/16-18	1.477 (37.52)	1.531 (38.89)	1.230 (31.24)
22	1-5/16-18	1.602 (40.69)	1.656 (42.06)	1.230 (31.24)
24	1-7/16-18	1.723 (43.76)	1.777 (45.14)	1.230 (31.24)

\* See page 158 for part numbers.

## Plug Assemblies with Backshell †

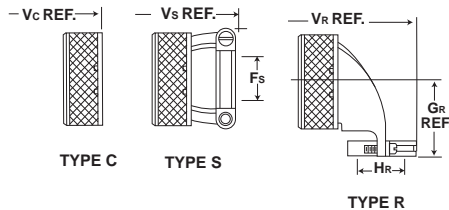

Backshell Assemblies not supplied with MS connectors.

Performance Specifications - Page 158

Contacts, Sealing Plugs, Assembly Tools - Pages 163, 165

Contact Arrangements - Page 162

Shell Size*	TYPE C	TYPE S		TYPE R		
	Vc Max.	Fs Max.	Vs Max.	Gr Max.	Hr Max.	Vr Max.
8						
10	1.507 (38.28)	.286 (7.26)	1.857 (47.17)	.880 (22.35)	.286 (7.26)	2.130 (54.10)
12	1.507 (38.28)	.416 (10.57)	1.857 (47.17)	.950 (24.13)	.416 (10.57)	2.265 (57.53)
14	1.507 (38.28)	.476 (12.09)	2.092 (53.14)	1.010 (25.65)	.476 (12.09)	2.355 (59.82)
16	1.507 (38.28)	.626 (15.90)	2.092 (53.14)	1.070 (27.18)	.626 (15.90)	2.490 (63.25)
18	1.507 (38.28)	.706 (17.93)	2.092 (53.14)	1.130 (28.70)	.706 (17.93)	2.589 (65.76)
20	1.507 (38.28)	.831 (21.11)	2.092 (53.14)	1.190 (30.23)	.831 (21.11)	2.722 (69.14)
22	1.507 (38.28)	.956 (24.28)	2.092 (53.14)	1.260 (32.00)	.956 (24.28)	2.845 (72.26)
24	1.507 (38.28)	1.081 (27.46)	2.092 (52.14)	1.320 (33.53)	1.081 (27.46)	2.967 (75.36)

\* See page 158 for part numbers. † To order backshell assemblies separately, see page 161.

## Backshells (Non-MS)

(Not supplied with MS Connectors)

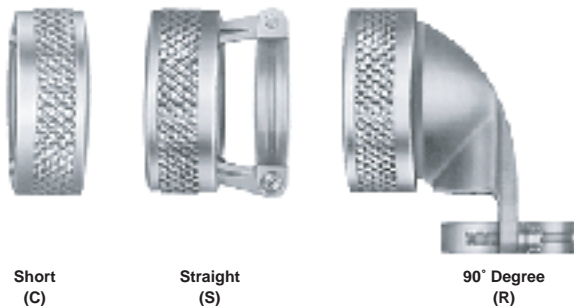

	TYPE C (SHORT)	TYPE S (Straight)	TYPE R (90°)
Shell Size*	ITT CANNON Conductive (Nickel finish)	ITT CANNON Conductive (Nickel finish)	ITT CANNON Conductive (Nickel finish)
10	057-0716-002	057-0683-002	057-0704-001
12	057-0717-002	057-0684-002	057-0705-001
14	057-0718-002	057-0685-002	057-0706-001
16	057-0719-002	057-0686-002	057-0707-001
18	057-0720-002	057-0687-002	057-0708-001
20	057-0721-002	057-0688-002	057-0709-001
22	057-0722-002	057-0689-002	057-0710-001
24	057-0723-002	057-0731-002	057-0711-001

## Contact Arrangements

Face view, pin insert

Shell Size  
No. of Contacts  
Service Rating

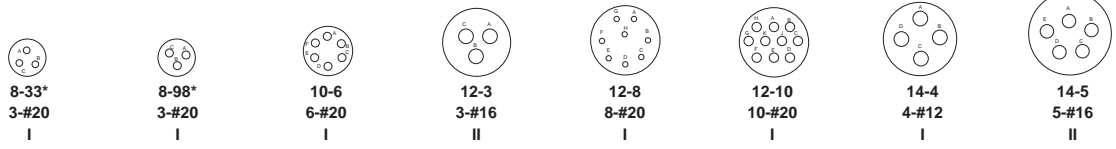

Shell Size  
No. of Contacts  
Service Rating

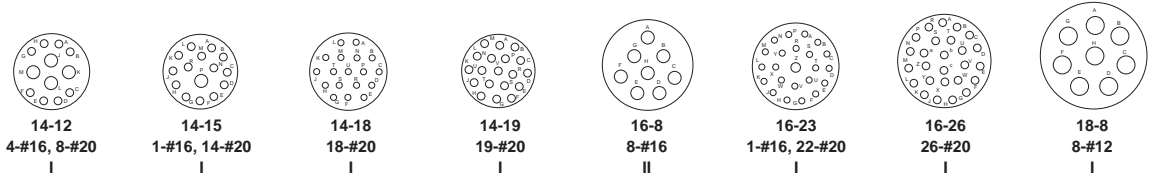

Shell Size  
No. of Contacts  
Service Rating

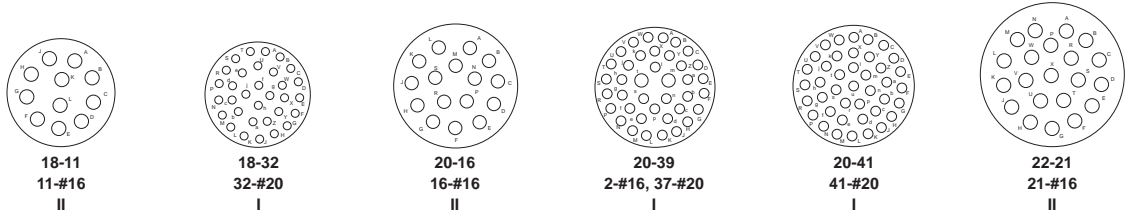

Shell Size  
No. of Contacts  
Service Rating

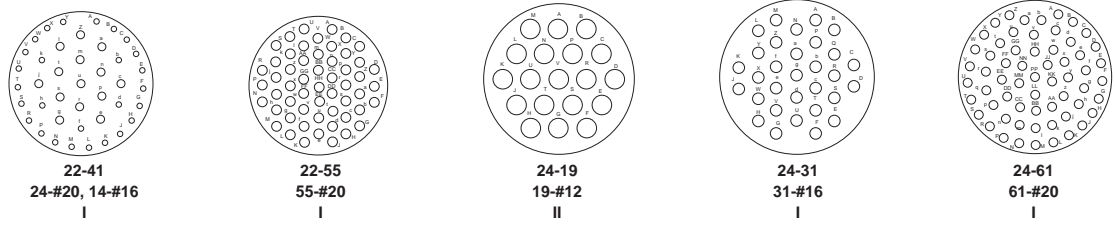

\* Layouts are available in shell styles MS3470 and MS3476 only.

## Alternate Insert Positions

Face view, pin insert

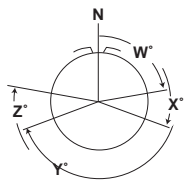

Contact arrangements requiring reduced diameter for lead-in chamfer on outer row of contact cavities as indicated below.

Shell	Contact Arrangements	Contact Cavities
8	33, 38	A, B, C
12	10	C, G
14	12	A, B, C, D, E, F, G, and H
14	18	A, C, E, G, J, and L
14	19	B, D, F, H, K, and M
16	26	A, B, C, D, E, F, G, H, J, K, L, M, N, P, and R)
18	32	A, B, C, D, E, F, G, H, J, K, L, M, N, P, R, S, and T
22	41	A, B, C, D, E, F, G, H, J, K, L, M, N, P, R, S, T, U, V, W, X, and Y

SHELL SIZE	ARRANGEMENT	POS CODE				
		N	W	X	Y	Z
8	33	0°	90°	-	-	-
	98	0°	-	-	-	-
10	6	0°	90°	-	-	-
	3	0°	-	-	180°	-
12	8	0°	90°	112°	203°	292°
	10	0°	60°	155°	270°	295°
14	4	0°	45°	-	-	-
	5	0°	40°	92°	184°	273°
	12	0°	43°	90°	-	-
	15	0°	17°	110°	155°	234°
	18	0°	15°	90°	180°	270°
16	19	0°	30°	165°	315°	-
	8	0°	54°	152°	180°	331°
	23	0°	158°	270°	-	-
	26	0°	60°	-	275°	338°
18	8	0°	180°	-	-	-
	11	0°	62°	119°	241°	340°
20	32	0°	85°	138°	222°	265°
	16	0°	238°	318°	333°	347°
	39	0°	63°	144°	252°	333°
22	41	0°	45°	126°	225°	-
	21	0°	16°	135°	175°	349°
24	41	0°	39°	135°	264°	-
	55	0°	30°	142°	226°	314°
24	19	0°	30°	165°	315°	-
	31	0°	90°	225°	225°	-
	61	0°	90°	180°	270°	324°

## Thru-Bulkhead Receptacle

PV-TBF

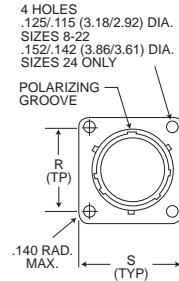
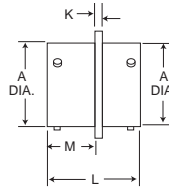
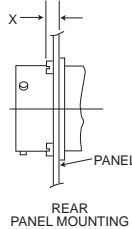
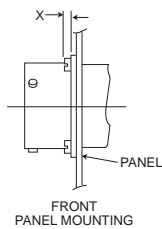

Shell Size	A Dia $\pm .003$ (0.08)	K $\pm .016$ (0.41)	L Max.	M $\pm .016$ (0.41)	R (TP)	S Max.	X Max.
8	.471 (11.96)	.062 (1.57)	1.125 (28.58)	.577 (14.66)	.594 (15.09)	.828 (21.03)	.218 (5.54)
10	.588 (14.94)	.062 (1.57)	1.125 (28.58)	.577 (14.66)	.719 (18.26)	.954 (24.23)	.218 (5.54)
12	.748 (19.00)	.062 (1.57)	1.125 (28.58)	.577 (14.66)	.812 (20.62)	1.047 (26.59)	.218 (5.54)
14	.873 (22.17)	.062 (1.57)	1.125 (28.58)	.577 (14.66)	.906 (23.01)	1.141 (28.98)	.218 (5.54)
16	.998 (25.35)	.062 (1.57)	1.125 (28.58)	.577 (14.66)	.969 (24.61)	1.234 (31.34)	.218 (5.54)
18	1.123 (28.52)	.062 (1.57)	1.125 (28.58)	.577 (14.66)	1.062 (26.97)	1.328 (33.73)	.218 (5.54)
20	1.248 (31.70)	.094 (2.39)	1.406 (35.71)	.703 (17.86)	1.156 (29.36)	1.453 (36.91)	.344 (8.74)
22	1.373 (34.87)	.094 (2.39)	1.406 (35.71)	.703 (17.86)	1.250 (31.75)	1.578 (40.08)	.344 (8.74)
24	1.498 (38.05)	.094 (2.39)	1.406 (35.71)	.703 (17.86)	1.375 (34.92)	1.703 (43.26)	.311 (7.90)

Notes: 1) Shell available in conductive (nickel finish) only. 2) Contacts are nonremovable.

## How to Order - PV-TBF

### SERIES PREFIX

PV-TBF - ITT Cannon prefix

### SHELL SIZE

8 through 24

### INSERT ARRANGEMENTS

10-6, 14-19, 16-8, 16-26, 18-32, 20-39, 20-41, 22-41, 22-55, 24-61.

SERIES PREFIX

SHELL SIZE

INSERT ARRANGEMENTS

CONTACT STYLE

ALTERNATE POLARIZING POSITION

CONTACT STYLE

Pin and socket

ALTERNATE POLARIZING POSITION

No designation required for normal. Standard MS alternate positions available.

Notes: 1) Shell available in conductive (nickel finish) only.  
2) Contacts are nonremovable.  
3) Designed to MS3119 configuration and meets the performance requirements of MIL-C-26482 Series 2.

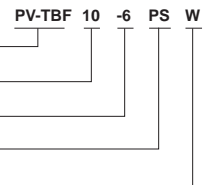

## Tooling



**Crimp Tool**  
M22520/1-01 Crimp Tool  
with M22520/1-02 Turret



**Insertion/Extraction Tools**



**CBT 520/530**

Contact Size	Wire Contact Tools					Unwired Contact Tools Cannon Pt. No.
	Cannon Part Number	M81969 Part Number	Insertion Color Tip	Extraction Color Tip	Superseded Mil. Pt. No.	
20	CIET-20-11 (274-7001-006)	M81969/14-11	Red	White	MS27534-20, MS3447-20, NAS1664-20	274-7007-000
16	CIET-16-03 (274-7002-000)	M81969/14-03	Blue	White	MS27534-16, MS3447-16, NAS1664-16	274-7008-000
12	CIET-12-04 (274-7003-000)	M81969/14-04	Yellow	White	MS27534-12, MS3447-12, NAS1664-12	274-7009-000

## Panel Cutouts

### Jam Nut Receptacle

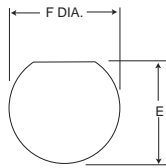

### Narrow Flange and Thru-Bulkhead/Wide Flange

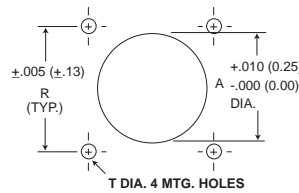

Shell Size	E ±.005 (0.13)	F Dia. ±.005 (0.13)
10	.661 (16.79)	.697 (17.70)
12	.824 (20.93)	.895 (22.73)
14	.948 (24.08)	1.010 (25.65)
16	1.072 (27.23)	1.135 (28.33)
18	1.197 (30.40)	1.260 (32.00)
20	1.322 (33.58)	1.385 (35.18)
22	1.447 (36.75)	1.510 (38.35)
24	1.572 (39.93)	1.635 (41.53)

Shell Size	Flange Front and Rear Mounting		Mounting Hole	
	A Dia.	R	T Dia.	Screw Size
8	.620 (15.75)	.594 (18.26)	.125 (3.14)	#4
10	.740 (18.80)	.719 (18.26)	.125 (3.17)	#4
12	.864 (21.95)	.812 (20.62)	.125 (3.17)	#4
14	.990 (25.15)	.906 (23.01)	.125 (3.17)	#4
16	1.118 (28.40)	.969 (24.61)	.125 (3.17)	#4
18	1.240 (31.50)	1.062 (26.97)	.125 (3.17)	#4
20	1.366 (34.70)	1.156 (29.36)	.125 (3.17)	#4
22	1.490 (37.85)	1.250 (31.75)	.125 (3.17)	#4
24	1.616 (41.05)	1.375 (34.92)	.155 (3.97)	#6

Shell Size	Flange Front and Rear Mounting		Mounting Hole	
	A Dia.	R	T Dia.	Screw Size
10	.740 (18.80)	.812 (20.62)	.155 (3.97)	#6
12	.864 (21.95)	.938 (23.93)	.155 (3.97)	#6
14	.990 (25.15)	1.031 (26.19)	.155 (3.97)	#6
16	1.118 (28.40)	1.125 (28.58)	.155 (3.97)	#6
18	1.240 (31.50)	1.203 (30.56)	.155 (3.97)	#6
20	1.366 (34.70)	1.297 (32.94)	.155 (3.97)	#6
22	1.490 (37.85)	1.375 (34.92)	.155 (3.97)	#6
24	1.616 (41.05)	1.500 (38.10)	.155 (3.97)	#6

## Panel Thickness

Shown here are the maximum panel thickness including screw head height allowable to ensure complete connector operation.

### Narrow Flange Receptacle

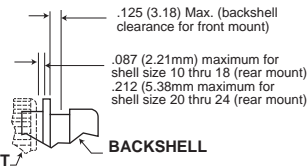

### Wide Flange Receptacle

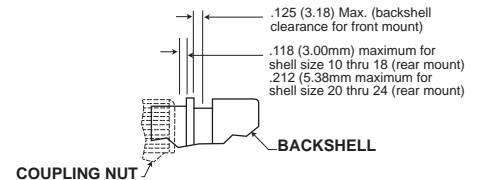

## Dummy Stowage Receptacles

### How to Order

#### PV DESCRIPTION

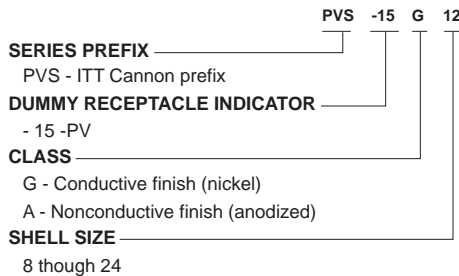

#### MS DESCRIPTION

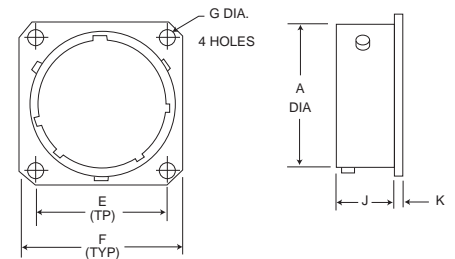
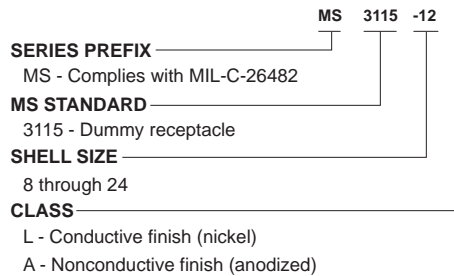

NOTE: Usable on KPT/KPSE series also.

Shell Size	A Dia. Max.	E (TYP)	F Max.	G Max.	J Max.	K Max.
8	.474 (12.04)	.594 (15.09)	.828 (21.03)	.125 (3.18)	.493 (12.52)	.078 (1.98)
10	.591 (15.01)	.719 (18.26)	.954 (24.23)	.125 (3.18)	.493 (12.52)	.078 (1.98)
12	.751 (19.08)	.812 (20.62)	1.047 (26.59)	.125 (3.18)	.493 (12.52)	.078 (1.98)
14	.876 (22.25)	.906 (23.01)	1.141 (28.98)	.125 (3.18)	.493 (12.52)	.078 (1.98)
16	1.001 (25.43)	.969 (24.61)	1.234 (31.34)	.125 (3.18)	.493 (12.52)	.078 (1.98)
18	1.126 (28.60)	1.062 (26.97)	1.328 (33.73)	.125 (3.18)	.493 (12.52)	.078 (1.98)
20	1.251 (31.78)	1.156 (29.36)	1.453 (36.91)	.125 (3.16)	.587 (14.91)	.110 (2.79)
22	1.376 (34.95)	1.250 (31.75)	1.578 (40.08)	.125 (3.18)	.587 (14.91)	.110 (2.79)
24	1.501 (38.13)	1.375 (34.92)	1.703 (43.26)	.152 (3.86)	.620 (15.75)	.110 (2.79)



## Protective Metal Caps

### Plugs

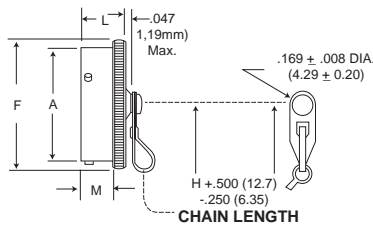

### Receptacles

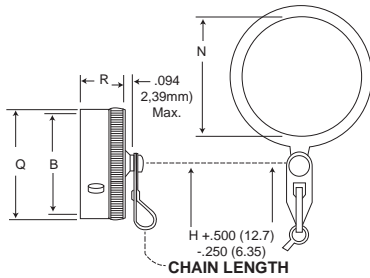

### SERIES PREFIX

PVS - ITT Cannon Prefix  
MS - Military approved version (Preferred)

### TYPE

80 or 3180 - Plug Cap  
81 or 3181 - Receptacle Cap

### SHELL SIZE

8 thru 24

### TERMINATION STYLE

C - Sash chain (MS approved)  
N - Sash chain with large ring for jam nut receptacle (81 or 3181 type only) (MS approved)

### FINISH

Blank - Cadmium plate, olive drab (MS approved)  
A - Hard anodic, non-conductive (MS approved)  
G - Nickel, conductive (not MS approved) (PVS only)

NOTE: Usable on Mil-C-26482 series 1 & 2  
N style used primarily on Jam Nut Receptacle.

PVS 80 -12 C A  
MS 3180 -12 C A

Shell Size	A Max. Dia.	B Max.	F Max. Dia.	H	L Max.	M Max.	N Min. Dia.	Q Max.	R Max.
8	.474 (12.04)	.486 (12.34)	.719 (18.26)	3.000 (76.20)	.562 (14.27)	.399 (10.13)	.578 (14.68)	.734 (18.64)	.562 (14.27)
10	.591 (15.01)	.607 (15.42)	.844 (21.44)	3.000 (76.20)	.562 (14.27)	.399 (10.13)	.703 (17.86)	.859 (21.82)	.562 (14.27)
12	.751 (19.08)	.766 (19.46)	1.000 (25.40)	3.500 (76.20)	.562 (14.27)	.399 (10.13)	.891 (22.63)	1.000 (25.40)	.562 (14.27)
14	.876 (22.25)	.890 (22.60)	1.125 (28.58)	3.500 (88.90)	.562 (14.27)	.399 (10.13)	1.016 (25.81)	1.125 (28.58)	.562 (14.27)
16	1.001 (25.43)	1.015 (25.78)	1.250 (31.75)	3.500 (88.90)	.562 (14.27)	.399 (10.13)	1.141 (28.98)	1.250 (31.75)	.562 (14.27)
18	1.126 (28.60)	1.141 (28.98)	1.375 (34.93)	3.500 (88.90)	.562 (14.27)	.399 (10.13)	1.266 (32.16)	1.375 (34.93)	.562 (14.27)
20	1.251 (31.78)	1.265 (32.13)	1.500 (38.10)	4.000 (101.60)	.625 (15.88)	.461 (11.71)	1.391 (35.33)	1.500 (38.10)	.562 (14.27)
22	1.376 (34.96)	1.390 (35.31)	1.625 (41.26)	4.000 (101.60)	.625 (15.88)	.461 (11.71)	1.516 (38.51)	1.625 (41.26)	.562 (14.27)
24	1.501 (38.13)	1.515 (38.48)	1.750 (44.45)	4.000 (101.60)	.658 (16.71)	.494 (12.55)	1.641 (41.68)	1.750 (44.45)	.602 (15.29)

## Contacts

Contact Size	Type	M39029 Number	Color Brands			ITT Cannon
			1st	2nd	3rd	
20	Socket	M39029/5-115	Brown	Brown	Green	031-9174-004
20	Pin	M39029/4-110	Brown	Brown	Black	030-9173-006
16	Socket	M39029/5-116	Brown	Brown	Blue	031-9206-006
16	Pin	M39029/4-111	Brown	Brown	Brown	030-9205-007
12	Socket	M39029/5-118	Brown	Brown	Grey	031-9186-003
12	Pin	M39029/4-113	Brown	Brown	Orange	030-9185-003

### Thermocouple Contacts

Contact Size	Alumel	Chromal
20 Pin	030-1831-000	030-1832-000
20 Socket	031-1013-000	031-1014-000

Contacts for printed circuit applications are also available. Consult factory.

## Wire Hole Fillers



Contact Size	Part Number		Superseded Mil. Pt. No.	Color Code
	Cannon	Military		
20	225-0070-000	MS27488-20	MS3187-20 M83723/28-20	Red
16	225-0071-000	MS27488-16	MS3187-16 M83723/28-16	Blue
12	225-0072-000	MS27488-12	MS3187-12 M83723/28-12	Yellow

## Assembly Procedures

### STRIPPING AND CRIMPING

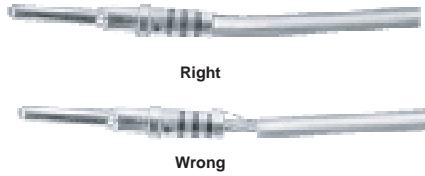

1. Strip wires according to contact size: 3/16" for #20 and 9/32" for #16 and #12. #20 contacts accommodate AWG wire sizes 20, 22, or 24; #16 accommodates 16, 18 or 20; and #12 accommodates 12 or 14.

2. Insert wire into rear of contact. Wire insulation must butt against rear of contact. Wire must be visible thru inspection hole.

3. Use M22520/1-01 crimp tool with proper crimp locator M22520/1-02. The color code hand on the contact (red for #20, blue for #16 and yellow for #12) must match the color code of the locator and the insertion tool throughout the crimping and assembly operations.



### CONTACT INSERTION



### OPENING

### COLORED END FOR INSERTION

4. Insert contact and wire into tool jaws. To crimp, squeeze handles together fully until ratchet release and allows handles to expand; otherwise, contact cannot be extracted from tool jaws. Maintain slight insertion pressure on wire while crimping contact to wire.

1. Remove backshell and put wired contacts thru cable clamp opening.

2. Used colored end of CIET tool for insertion. Place wire into tool at large opening. To facilitate contact insertion, a 6-in. min. free length of wire is recommended.

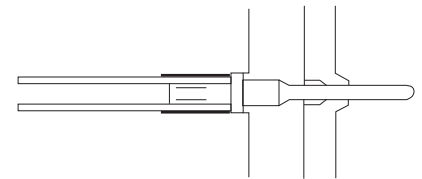

3. Slide back tool on wire while holding thumb against wire at opening. Wire will slip into tool.

**NOTE: Socket contacts should be inserted partially into grommet by hand before using insertion tool.**

4. With tool pressed against shoulder of contact, starting at the center cavity, insert wired contact and tool into properly identified cavity at rear of plug with firm, even pressure. Do not use excessive pressure.

5. When contact bottoms, a slight click can be heard as tines of metal retaining clip snaps into place behind contact shoulder.



### CONTACT EXTRACTION



6. Withdraw tool from rear of plug. To be sure that contact is locked, pull back lightly on wire. Then remove tool from wire and proceed with other contacts.

7. After all contacts are inserted, fill unwired cavities with sealing plugs (insert head last and leave end protruding for ease of removal), assemble backshell on rear of connector.

1. Remove backshell and slide back along wires to allow access. To extract a contact, use white end of CIET tool. Place wire into tool at large opening. Slide back tool on wire while holding thumb against wire at opening. Wire will slip into tool.

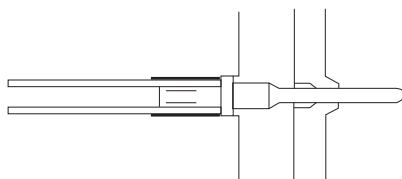

2. Push tool into rear of plug until it bottoms. At this point, tool releases tines on retaining clip so that contact can be extracted.

3. While maintaining slight insertion force on tool, firmly hold wire against serrated shoulder at center of tool and extract both wired contact and tool from plug.

### COMPLETION

### BROKEN CIRCLE

### BREAK

4. Check face of plug or receptacle for proper contact installation. In socket inserts with a large number of contact, cavities are identified in a spiral pattern. A projecting line from the spiral indicates omission of a letter; a broken circle around a cavity indicates transition between capitals and lower case and double letters.