

cannon

Microminiature Connectors Catalog



ITT

ENGINEERED FOR LIFE



Amazing Things Happen

When Great Things Connect

More than a Century of Connections

ITT Cannon is a leading global manufacturer of interconnect solutions serving international customers in the aerospace and defense, industrial, transportation and medical end markets. Whether delivering critical specs to aircraft pilots, streaming data through communications satellites, or enabling ultrasound equipment to give expectant parents a first look at their unborn child, ITT Cannon connects the world's most important information with those who need it. Since 1915, Cannon products have been used in a history of "firsts." From the first "talking" movie to the first man on the moon, Cannon has set the standard for reliable, harsh environment interconnect solutions. Today we proudly continue our legacy of innovation with a goal to connect the world and inspire the successes of the next century—because amazing things happen when great things connect.

The ITT Cannon Difference

- World-class design, engineering & manufacturing capabilities
- A commitment to quality at every touch point
- Global product reach with local customer service & support
- Unrivaled customization experience
- An innovative & trusted business partner

About ITT

ITT is a diversified leading manufacturer of highly engineered critical components and customized technology solutions for the energy, transportation and industrial markets. Building on its heritage of innovation, ITT partners with its customers to deliver enduring solutions to the key industries that underpin our modern way of life. ITT is headquartered in White Plains, N.Y., with employees in more than 35 countries and sales in approximately 125 countries. For more information, visit ITT.com





ITT Cannon's portfolio
of high performance interconnects is one of the most extensive in the industry, offering a wide range of custom and off-the-shelf connectors and cable assemblies for applications in the Commercial Aerospace, Military & Defense, Transportation, Industrial and Medical end markets. For more details, visit ITTCannon.com.

Microminiature Interconnect Solutions

Ultra lightweight, space-saving connectors and cable assemblies for unmatched performance & reliability in the harshest environments

ITT Cannon is your one-stop source for the design and manufacture of Microminiature solutions for the high performance connector market.

Offering one of the broadest selections of standard and custom Microminiature products available, our versatile portfolio includes a wide range of shell styles and configurations including rectangular, circular, quick disconnect, high speed signal, filter, hermetic, mixed signal packages and strip-style.

Each one features our Cannon-engineered Micro Twist Pin Contact System for maximum performance, as well as unique mechanical engagement and locking mechanisms to ensure reliability in the harshest environments.

Ideally suited for markets and applications that require extremely small, lightweight and reliable interconnects, our Microminiature Connectors feature higher density contact configurations than traditional rectangular solutions—without sacrificing quality or performance.

Key Benefits

- Ultra small, lightweight & high performance form factor
- Available in 8 shell sizes that accommodate from 9 to 100 contacts, plus special power and coaxial contact arrangements
- Exceptional bandwidth performance
- Durability to withstand high shock and vibration
- Unique mechanical engagement & locking mechanisms
- Custom & turnkey cable assemblies
- RoHS compliant part numbers & plating options

Key Features

- Micro Twist Pin Contact System recessed into plug insulators
- Positions: 9, 15, 21, 25, 31, 27, 51, 100
- Wire size: AWG 24 thru AWG 32
- Micro socket: Free standing used in receptacle side
- Current rating: 3A
- Durability: 500 mating cycles
- Contacts: Copper alloy; gold plated
- Low profile configurations available
- Designed to MIL-DTL-83513 specifications
- Operating temperatures:
 - Micro MDM Standard: -55°C to +150°C
 - High Temp Micro MDM: -55°C to +200°C
 - Ultra-High Temp Micro MDM: -55°C to +230°C



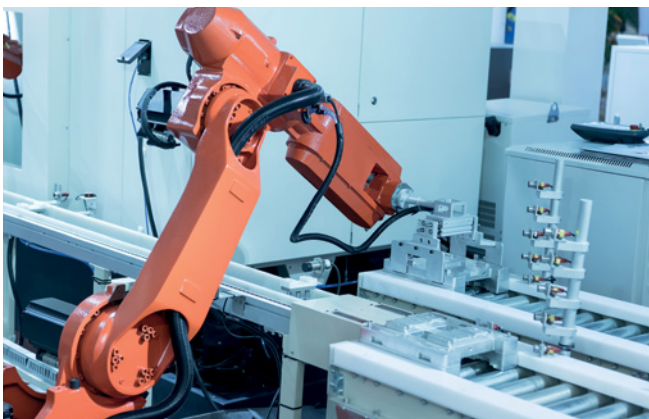
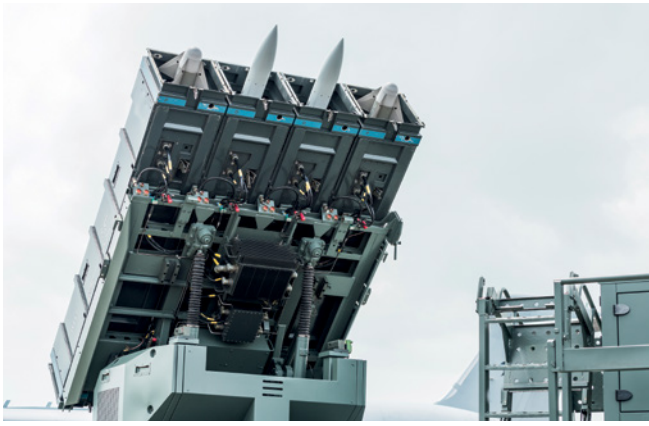

Markets & Applications

From automated space vehicles roving the surface of Mars, to oil & gas exploration in remote locations the world over, ITT Cannon's versatile, high performance Microminiature Connectors transmit data, power and signal when it matters most.

Twist Pin Technology

At the heart of our Microminiature Connector Series is the Twist Pin Contact System, which Cannon engineers first developed & licensed in the 1960s. Highly reliable Twist Pin Technology allows continuity in very dense areas and under severe shock and vibration, requiring low engagement and separation forces. It is superior technology that outperforms traditional machined or stamped electrical contract systems. To read more about this pioneering Cannon technology, please see page 7.

Cable Assemblies

Our extensive expertise in designing and manufacturing Microminiature Connectors translates into our ability to design and deliver both Turnkey and Custom Cable Assemblies. For more information, please see page 76.

Microminiature Product Line

- MDM Micro-D (MIL-DTL-83513)
- MDM PCB (MIL-DTL-83513)
- MDLM Micro-D Metal Shell, Low Profile
- MDM F222 High Temp Micro
- MDM F300 Ultra-High Temp Micro
- MCM C/P Coaxial Power Micro
- MDMH Hermetic Micro
- TMDM Filter Micro
- MD*Plastic Micro-D
- MDB Coaxial Micro
- MJS Micro Center Jacksrew
- MIK Micro Circular
- MIKM Micro Circular
- MIKQ Micro Circular
- MT* Strip-Style
- ME Micro Edgeboard
- Customs & Specials

For more details, see our Product Selection Guide on pp 8-9.

Table of Contents

| | |
|--|-------|
| Cannon Brand & Portfolio Overview..... | 2-3 |
| Microminiature Interconnect Solutions Overview | 4-5 |
| Table of Contents | 6 |
| Cannon Twist Pin Contact System | 7 |
| Product Selection Guide | 8-9 |
| Micro-D Metal Shell - .050" Contact Spacing (MDM)..... | 10-18 |
| Micro-D Coaxial/Power - .050" Contact Spacing (MDM-C/P)..... | 19-20 |
| Micro-D PCB - .050" Contact Spacing (MDM-PCB)..... | 21-24 |
| Micro-D Metal Shell Low Profile - 0.50" Contact Spacing (MDLM)..... | 25-29 |
| 200°C High-Temp Micro (MDM-F222) | 30-31 |
| 230°C Ultra-High Temp Micro (MDM-F300)..... | 32 |
| Accessories | 33 |
| Micro-D Metal Shell - .050" Contact Spacing (MIL-DTL-83513)..... | 34-35 |
| Hermetic (MDMH)..... | 36-37 |
| Filter (TMDM)..... | 38-40 |
| Micro-D Plastic Shell - .050" Contact Spacing (MD/MDB/MDB-PCB, MDV)..... | 41-52 |
| Micro Center Jackscrew (MJS)..... | 53-57 |
| Microminiature Circular - .050" Contact Spacing (MIK, MIKM, MIKQ) | 58-64 |
| Microstrips .050" Contact Spacing (MT) | 65-68 |
| Microminiature Strip - .100/.050" Contact Spacing (MT)..... | 69-70 |
| Micro Edgeboard - .050" Contact Spacing (MEB) | 71-75 |
| Cable Assemblies..... | 76 |
| Flex Circuit Cable Assembly..... | 77 |
| Custom Back Shells | 78 |
| Appendix | |
| Standard Wire Termination "L" Code Chart..... | 79 |
| Standard Wire Termination "H" Code Chart | 80 |
| Wire Color Code Chart..... | 81 |
| Micro-D Accessories Dust Caps | 82 |
| About ITT Cannon..... | 83 |
| Product Safety Information..... | 84 |
| We Connect When It Matters Most | 85-86 |

Cannon Twist Pin Contact System

At the heart of our Microminiature Connector Solutions is Cannon's proven Twist Pin Contact System, which features superior electrical and mechanical technology that outperforms traditional machined or stamped electrical contact systems. Highly reliable twist pin technology allows continuity in very dense areas and under severe shock and vibration, requiring low engagement and separation forces. Termination can consist of uninsulated pigtails or insulated wire all pre-harnessed at our factory to customer specifications. Cannon engineers developed and introduced Twist Pin Contact Technology in the 1960s, and have used it in the Cannon MDM Series Microminiature Connectors for decades. ITT Cannon's Twist Pin System consists of the Micro Socket and the Micro Pin or Twist Pin.



Advantages of Cannon's Twist Pin Contact System

- Seven points of electrical contact (Micro 0.050 inch interconnect)
- Contact and crimp sleeve materials carefully optimized for extremely reliable crimps; no design tradeoffs
- Seamless crimp sleeves
- Multiple 4-indent wire crimps standard & smaller bore micro socket contacts
- Standard integral tail & thru bundle MicroPin contacts (high density packaging)
- High mating cycles
- High current handling capabilities
- System qualification in numerous aerospace, defense, electronic & high temperature geophysical applications
- Wide array of wire terminations

How It Works: POS-A-Line Contact Alignment*

The flexible Twist Pin is recessed into the insulator and the rigid socket is exposed, reversing the traditional positions of pin and socket. During mating, the socket is guided into the pin insulator by the lead-in chamfer. The pin is kept from flexing beyond the socket capture radius by the walls of the cavity. The hemispherical weld of controlled radius at the tip of the pin combines with the lead-in chamfers of the socket contact and the pin insulator to cam the pin into alignment. By controlling the welding process and the dimensions of the socket contact and the insulators, it is impossible for the recessed pin to escape the socket capture radius.

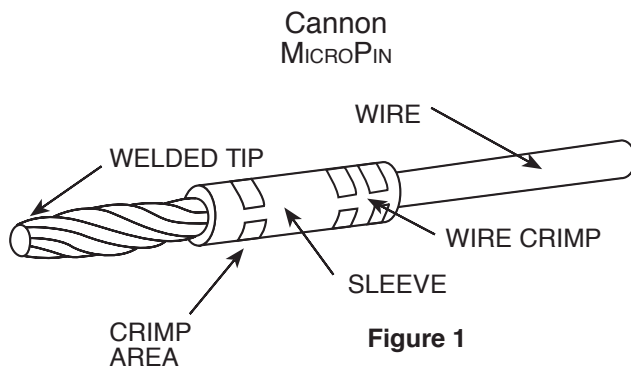

Figure 1

*Figure 1 - The Twist Pin Contact System consists of several stranded cores making up the wire bundle. The strands are subsequently heat treated and a weld is performed on the tip of each contact. Crimp sleeves are then inserted over the contact and crimp areas are defined to produce a seamless crimp system. The Twist Pin Contact System is referred to by ITT Cannon as a Pos-A-Line contact alignment system. Our reference to this system identifies that the flexible Twist Pin is recessed into the insulator and the rigid socket is exposed thus reversing the traditional positions of the pin and socket. During the mating sequence, the socket is guided into the pin insulator by the lead-in chamfer. The pin is kept from flexing beyond the socket capture radius by the walls of the cavity. The hemispherical weld of controlled radius at the tip of the pin combines with the lead-in chamfer of the socket contact and the pin insulator to cam the pin in alignment. ITT Cannon has developed a very robust Six Sigma manufacturing process that controls the welding process as well as the dimensions of the socket contact and insulator material. The net result is a contact system that makes it impossible for the recessed pin to escape the socket capture radius.

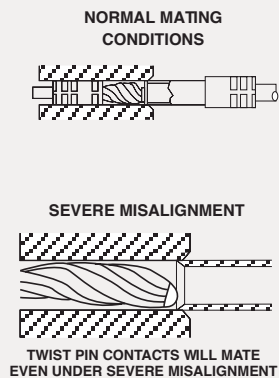









Figure 2

Figure 2 - Illustrates the Twist Pin features, as well as mating & severe misalignment conditions.

Cannon Microminiature Connectors | Product Selection Guide









| | MDM | MDM PCB | MDLM | MDM Coaxial/Power Combo | High Temp Micro MDM F222 | Ultra-High Temp Micro MDM F300 | MIL-DTL-83513 | MDMH Hermetics |
|---------------------------|---|--|--|---|---|--|--|---|
| |  |  |  |  |  |  |  |  |
| Applications | MDM Connectors are highly reliable, extremely small and lightweight with higher density contact configurations than traditional rectangular connectors. | MDM-PCB Metal Shell High Density Connectors are designed for use with flex circuitry, flat cable and printed circuit boards. | MDLM Connectors offer are ideally suited for harsh environment Aerospace & Defense, Industrial and Transportation applications that require a thinner, lower profile design package. | MDM C/P Connectors have been tooled in several coaxial layouts and offer versatility by combining coaxial and signal lines in the same connector. | MDM F222 High Temp Series is tested to withstand 200°C continuous operating temperature for 500 hours and meets the harsh environment requirements of the Oil and Gas exploration industries. | MDM F300 High Temp Series is tested to withstand 230° continuous operating temperature for 500 hours and meets the harsh environment requirements of the Oil and Gas exploration industries. | MIL-DTL-83513 Connectors provide high density, lightweight, field-proven twist pin contact design used in avionics gear, communications equipment and satellites, as well as medical applications. | Hermetically-sealed MDMH Connectors are designed for applications where a vacuum, inert gas or a constant controlled pressure are required to eliminate adverse effects created by atmospheric changes. |
| Available Layouts | Plug and Socket | Plug and Socket | Plug and Socket | Plug and Socket | Plug and Socket | Plug and Socket | Plug and Socket | Plug and Socket |
| Current Rating | 3A max. | 3A max. | 3A max. | 3A max. | 3A max. | 3A max. | 3A max. | 3A max. |
| Contact Resistance | 8 milliohms max. | 8 milliohms max. | 8 milliohms max. | 8 milliohms max. | 8 milliohms max. | 8 milliohms max. | 8 milliohms max. | 24 milliohms max. |
| Contact Material | gold plated copper alloy | gold plated copper alloy | gold plated copper alloy | gold plated copper alloy | gold plated copper alloy | gold plated copper alloy | gold plated copper alloy | gold plated copper and steel |
| Shell | Metal | Metal | Metal | Metal | Metal | Metal | Metal | Metal |
| Shell Material | Aluminum | Aluminum | Aluminum | Aluminum | Steel | Stainless Steel | Aluminum | Steel |
| Available Layouts | 9, 15, 21, 25, 31, 37, 51 & 100 | 9, 15, 21, 25, 31, 37, 51 & 100 | 9, 15, 21, 25, 31, 37, 51 | 7C/P2, 24C/P4, 27C/P5 & 10C/P10 | 9, 15, 21, 25, 31, 37 & 51 | 9, 15, 21, 25, 31 & 37 | 9, 15, 21, 25, 31, 37, 51 & 100 | 9, 15, 21, 25, 31, 37 & 51 |
| Configuration | Polarized D | Polarized D | Polarized D | Polarized D | Polarized D | Polarized D | Polarized D | Polarized D |
| RoHS Plating | Available | Available | Available | Available | Not Available | Not Available | Available | Available |
| Factory Terminated | Yes* | Yes | Yes | Yes | Yes | Yes | Yes | Yes* |
| Space Applications | Available | Available | Available | Available | Yes | No | Available | Yes |

* Solderpot versions available for end user termination



Dimensions shown in mm
Specifications and dimensions subject to change

www.ittcannon.com

| | TMDM Filter | MD** | MJS | MIK | MIKM | MIKQ | MT* | MEB |
|---------------------------|--|---|---|---|---|---|---|---|
| |  |  |  |  |  |  |  |  |
| Applications | MDM Filter Connectors are designed for use in commercial avionics and equipment, with increasing emphasis on EMI, RFI and EMP shielding. | MD** Microminiature Connectors are used in applications requiring highly reliable, extremely small, lightweight plastic connectors. | MJS Jackscrew Series provides a reliable interconnect for board-to-board, board-to-cable and cable-to-cable applications. | MIK Micro Circular Series are rugged yet lightweight and meet or exceed the applicable requirements of MIL-DTL-83513. Applications include biomedical, instrumentation and miniature black boxes. | MIKM Micro Circular Series are rugged yet lightweight and meet or exceed the applicable requirements of MIL-DTL-83513. Application include biomedical, instrumentation and miniature black boxes. | MIKQ Micro Circular Series are rugged yet lightweight and meet or exceed the applicable requirements of MIL-DTL-83513. Application include biomedical, instrumentation and miniature black boxes. | MT Microstrips provide an extremely dense and reliable interconnection solution in a minimum profile package, offering exceptional board-to-wire application flexibility. | Micro Edgeboard (MEB) Series provides a combination of high density and reliability for applications in airborne and space systems, computers and peripherals, and industrial/commercial control systems. |
| Available Layouts | Plug and Socket | Plug and Socket | Plug and Socket | Plug and Socket | Plug and Socket | Plug and Socket | Plug and Socket | Plug and Socket |
| Current Rating | 3A max. | 3A max. | 3A max. | 3A max. | 3A max. | 3A max. | 3A max. | 3A max. |
| Contact Resistance | 15 milliohms max. | 8 milliohms max. | 8 milliohms max. | 8 milliohms max. | 8 milliohms max. | 8 milliohms max. | 8 milliohms max. | 8 milliohms max. |
| Contact Material | gold plated copper alloy | gold plated copper alloy | gold plated copper alloy | gold plated copper alloy | gold plated copper alloy | gold plated copper alloy | gold plated copper alloy | gold plated copper alloy |
| Shell | Metal | Plastic | Plastic | Plastic | Metal | Metal | Plastic | Plastic |
| Shell Material | Aluminum | Thermoplastic & Thermoset | Thermoplastic & Thermoset | Thermoplastic | Steel | Steel | Thermoplastic | Thermoset |
| Available Layouts | 9, 15, 21, 25, 31, 37 & 51 | 9, 15, 21, 25, 31, 37 & 51 | 10, 26, 51 & 66 Rect/unshrouded 16, 28 & 35 - Rect/shrouded 26, 38, 42 & 76 - Polarized D | 7 & 55 | 7, 55 & 85 | 7, 19 & 37 | MTV - 1 thru 120 MTB - 1 thru 80 | 64, 128, 92 & 184 |
| Configuration | Polarized D | Polarized D | Rectangular & Polarized D | Circular | Circular | Circular | | |
| RoHS Plating | No | Available | Available | Available | Available | Available | Available | Available |
| Factory Terminated | Yes | Yes* | Yes* | Yes | Yes | Yes | Yes | Yes |
| Space Applications | Yes | Available | Available | Yes | Yes | Yes | Yes | Yes |

Dimensions shown in mm
Specifications and dimensions subject to change

Micro-D Metal Shell - .050" Contact Spacing

MDM



Cannon MDM Series Microminiature Connectors are used in applications requiring highly reliable, extremely small and lightweight solutions with higher density contact configurations. They are available in eight shell sizes that accommodate from 9 to 100 contacts, as well as special arrangements with power and coaxial contacts. Cannon MDM Series Microminiature Connectors employ size 24 Micro-Pin / Micro-Socket Contacts on .050 (1.27) centers in a contact density identical to the standard Micro-D connector series, but with Aluminum shells to increase strength, prevent chipping, cracking or breaking and provide electromagnetic (EMI and RFI) shielding. They also feature a silicone elastomer compression interfacial seal to provide a moisture and humidity seal between each contact and between the contacts and shell.

Specifications

STANDARD MATERIALS AND FINISHES

| | |
|-------------------------|---|
| Shell | - 6061-T6 Aluminum alloy per QQ-A-200/8, yellow chromate/cadmium, Type II, Class 3 over electroless nickel per SAE AMS-C-26074, Class 4. |
| Insulator | - Liquid Crystal Polymer per MIL-M-24519, Type GLCP-30F (9-100) - Glass filled diallyl phthalate per MIL-M-14, Type SDGF (7*2 and 24*4) - Polyphenylene sulfide per MIL-M-24519, Type GST-40F (16*5) - Polyester per MIL-M-24519, Type GPT-30F (10*10) |
| Contacts | - Copper alloy, gold plate |
| Mounting Hardware | - 300 Series stainless steel, passivate |
| Kit, Jackpost (3) items | - 300 Series stainless steel, passivate |
| Washer | - 400 Series stainless steel, passivate |
| Standard Epoxy | - Hysol EE4215/HD3561, color black - Hysol EE4198/HD3561, color green - Hysol MG40FS molding compound |

MECHANICAL FEATURES

| | |
|-------------------------|---|
| Coupling | - Friction/jackscrews |
| Polarization | - Keystone-shaped shells |
| Contact Spacing Centers | - .050 (1.27) |
| Shell Styles | - Plug and receptacle |
| No. of Contacts | - 9 thru 100 signal; 5 signal/2 coaxial; 5 signal/2 power; 11 signal/5 coaxial; 11 signal/5 power; 0 signal/10 coaxial; 0 signal/10 power; 20 signal/4 coaxial; 20 signal/4 power |
| Coaxial Cable | - RG - 178/U |
| Wire Size | - #24 thru #32 AWG |
| Contact Termination | - Multiple indent crimp |

Performance Data

| Test | Method | Criteria of Acceptance |
|----------------------------------|---|---|
| Dielectric Withstanding Voltage | Method 3001: 600 VAC at sea level 150 VAC at 70,00' altitude | No breakdown No breakdown |
| Insulation Resistance | Method 3003 | 5,000 megohms minimum |
| Thermal Shock | Method 1003. Condition A: - 55°C to + 125°C | No physical damage |
| Physical Shock | Method 2004, Condition E: 50 G's, 3 axes, 6 millisecond duration sawtooth pulse | No physical damage No loss of continuity > 1 μsec |
| Vibration | Method 2005, Condition IV: 20 G's, 10-20,000 Hz. 12 hrs | No physical damage No loss of continuity > 1 μsec |
| Durability | 500 cycles of mating and unmating, 500 CPH max. | No mechanical or electrical defects |
| Moisture Resistance | Method 1002, Type II, omit steps 7a & 7b | Insulation resistance > 100 megohms |
| Salt Spray | Method 1001, Condition B: 48 hours | Shall be capable of mating and unmating, and meet contact resistance requirements |
| Contact Resistance (MIL-STD-202) | Method 1001, Condition B: At 3 amps At 1 milliamp | 8 milliohms maximum 10 milliohms maximum |
| Contact Retention | Per MIL-DTL-83513 | 5 lb. minimum axial load |



Dimensions shown in mm
Specifications and dimensions subject to change

www.ittcannon.com

Micro-D Metal Shell - .050" Contact Spacing

MDM

How to Order (For MIL-DTL-83513 ordering information, see pp. 29-30)

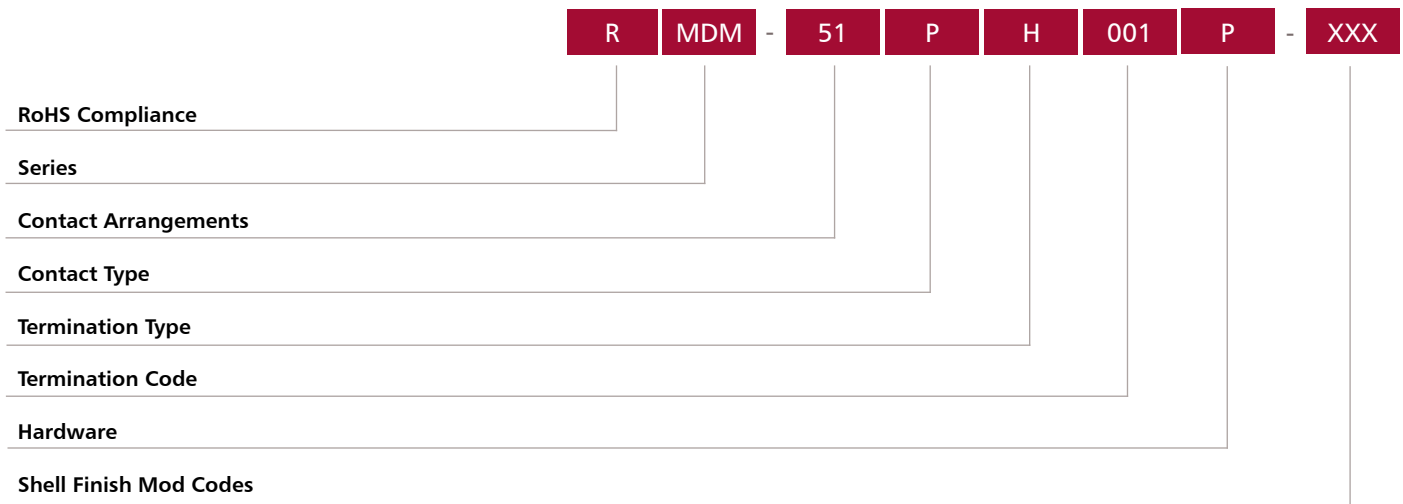

Series

MDM: (Size 9-100) Liquid Crystal Polymer (LCP)
MDM: (Combo Layout) Diallyl Phthalate (DAP)

Contact Arrangements

9-15-21-25-31-37-51-100 (standard)
16C5, 10C10, 7C2, 24C4 (coaxial) } or combination of
16P5, 10P10, 7P2, 24P4 (power) } coax and power

Contact Type

P - Pin
S - Socket

Termination Type

H - Harness-insulated wire.
L - Solid-uninsulated wire.
S - Solder pot to accept #26 AWG MAX. harness wire. (Not available with power contact arrangements.)

Termination code*

(H) 001 - 18", 7/34 strand, #26 AWG, MIL-W-16878/4, Type E Teflon, yellow.
(H) 003 - 18", 7/34 strand, #26 AWG, MIL-W-16878/4, Type E Teflon, color coded to MIL-STD-681 System I.
(L) 1 - 1/2" uninsulated solid #25 AWG gold plated copper.
(L) 2 - 1" uninsulated solid #25 AWG gold plated copper.

Hardware

M - Military specification hardware, see page 16 for military hardware codes.
P - Jackpost
K - Jackscrew-standard profile
L - Jackscrew-low profile
F - Float mount
B - No hardware standard.091 (2.31) dia. hole for sizes 9-51; .120 (3.05) dia. hole for size 100.
A - .125 (3.18) dia. mounting holes for sizes 9-51; .166 (4.22) dia. hole for size 100.
B1 - .1475 (3.75) dia. hole for size 100 (Per MIL-DTL-83513)

Shell Finish Modification Codes

No Number - (Standard cadmium/yellow chromate over nickel)
A174 - Electroless nickel
A172 - Gold over nickel
A141 - Irridite/alodine
A30 - Black anodize

Modification Codes

F222 - High Temp (200°C)
F234 - 24 AWG Wire
A295 - Non-Magnetic
K135 - F222 and A295
A214 - Hot tin dip
K139 - F222 High (200°C) and F234 (24 AWG Wire)

For additional termination codes, please see pages 79-81.



Micro-D Metal Shell - .050" Contact Spacing

MDM

Contact Arrangements

Face View of Pin insert - Use Reverse Order for Socket Side

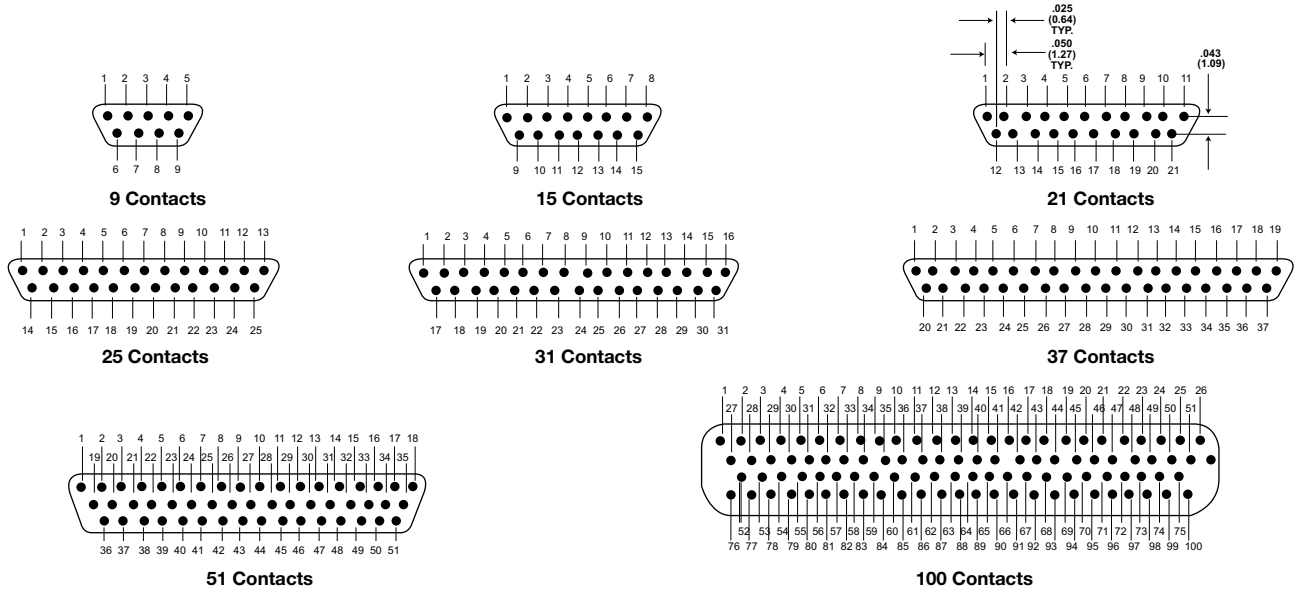

Contact identification numbers are for reference only and do not appear on insulation or connector body.

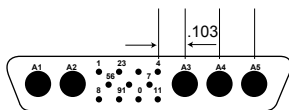

Size 51 Shell
11 Micro contact
5 Coax or 5 Power
16P5
16C5

Coaxial

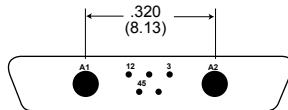

Size 25 Shell
5 Micro contact
2 Coax or 2 Power
7P2
7C2

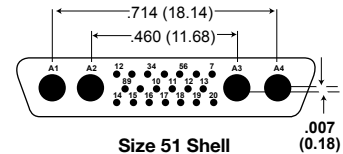

Size 51 Shell
20 Micro contacts
4 Coax or 4 Power
(Not MS)
25P4
25C4

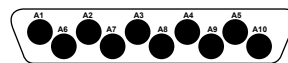

Size 100 Shell
0 Micro contact
10 Coax or 10 Power
10P10
10C10

Micro-D Metal Shell - .050" Contact Spacing

MDM

(Conforms to MIL-DTL-83513)

Plug

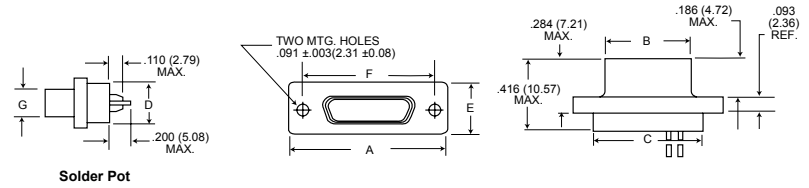

Receptacle

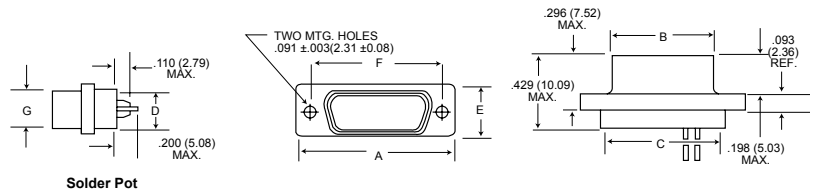

Receptacle (MDM-100 only)

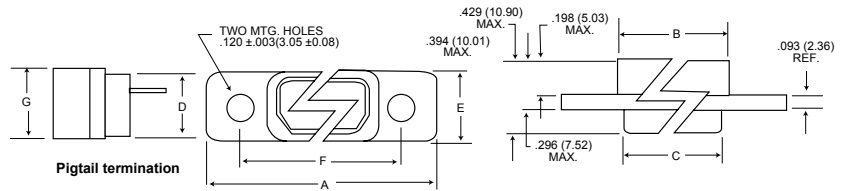

| Part Number By Shell Size | A Max. | B Max. | C Max. | D Max. | E Max. | F + .005 (0.13) | G Max. | Average Weights** oz. (gm.) ±5% |
|---------------------------|---------------|---------------|---------------|-------------|--------------|-----------------|--------------|---------------------------------|
| MDM-9P* | .785 (19.94) | .334 (8.48) | .400 (10.16) | .270 (6.86) | .308 (7.82) | .565 (14.35) | .185 (4.70) | .063 (1.79) |
| MDM-9S* | .785 (19.94) | .402 (10.21) | .400 (10.16) | .270 (6.86) | .308 (7.82) | .565 (14.35) | .253 (6.43) | .063 (1.79) |
| MDM-15P* | .935 (23.75) | .484 (12.29) | .550 (13.97) | .270 (6.86) | .308 (7.82) | .715 (18.16) | .185 (4.70) | .084 (2.39) |
| MDM-15S* | .935 (23.75) | .552 (13.97) | .550 (13.97) | .270 (6.86) | .308 (7.82) | .715 (18.16) | .253 (6.43) | .083 (2.37) |
| MDM-21P* | 1.085 (27.56) | .634 (16.10) | .700 (17.78) | .270 (6.86) | .308 (7.82) | .865 (21.97) | .185 (4.70) | .105 (2.99) |
| MDM-21P* | 1.085 (27.56) | .702 (17.83) | .700 (17.78) | .270 (6.86) | .308 (7.82) | .865 (21.97) | .253 (6.43) | .104 (2.97) |
| MDM-25P* | 1.185 (30.10) | .734 (18.64) | .800 (20.32) | .270 (6.86) | .308 (7.82) | .965 (24.51) | .185 (4.70) | .119 (3.39) |
| MDM-25S* | 1.185 (30.10) | .802 (20.37) | .800 (20.32) | .270 (6.86) | .308 (7.82) | .965 (24.51) | .253 (6.43) | .118 (3.36) |
| MDM-31P* | 1.335 (33.91) | .884 (22.45) | .950 (24.13) | .270 (6.86) | .308 (7.82) | 1.115 (28.32) | .185 (4.70) | .140 (3.99) |
| MDM-31S* | 1.335 (33.91) | .952 (24.18) | .950 (24.13) | .270 (6.86) | .308 (7.82) | 1.115 (28.32) | .245 (6.43) | .139 (3.96) |
| MDM-37P* | 1.485 (37.72) | 1.034 (26.26) | 1.100 (27.94) | .270 (6.86) | .308 (7.82) | 1.265 (32.13) | .185 (4.70) | .161 (4.59) |
| MDM-37S* | 1.485 (37.72) | 1.102 (27.99) | 1.100 (27.94) | .270 (6.86) | .308 (7.82) | 1.265 (32.13) | .253 (6.43) | .160 (4.56) |
| MDM-51P* | 1.435 (36.45) | .984 (24.99) | 1.050 (26.67) | .310 (7.87) | .351 (8.92) | 1.215 (30.86) | .228 (5.79) | .193 (5.50) |
| MDM-51S* | 1.435 (36.45) | 1.052 (26.72) | 1.050 (26.67) | .310 (7.87) | .351 (8.92) | 1.215 (30.86) | .296 (7.52) | .188 (5.35) |
| MDM-100P* | 2.170 (55.12) | 1.384 (35.15) | 1.442 (36.63) | .360 (9.14) | .394 (10.01) | 1.800 (45.72) | .271 (6.88) | .500 (14.3) |
| MDM-100S* | 2.170 (55.12) | 1.508 (38.10) | 1.442 (36.63) | .360 (9.14) | .394 (10.01) | 1.800 (45.72) | .394 (10.01) | 1.040 (29.5) |

*Add lead type and length; see How To Order.

***Weight given is 1/2" uninsulated, solid, #25 AWG gold plated copper pigtails.

Panel Mounting Dimensions (Sizes 9 - 100)

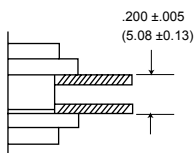

Plug and Receptacle Rear Mounted

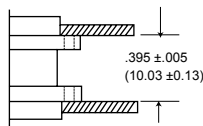

Plug and Receptacle Front Mounted

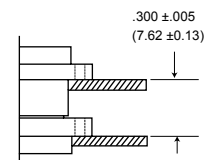

Plug Front Mounted Receptacle Rear Mounted

Dimensions shown in mm
Specifications and dimensions subject to change

www.ittcannon.com



Micro-D Metal Shell - .050" Contact Spacing

MDM

Connector Saver



Save wear and tear on your equipment and system connectors with Cannon's MDM Connector Saver. Eliminate multiple mating and de-mating during testing and final checkout by simply mating the "Connector Saver" to your unit and using the opposite side for your testing interface. This result is less wear, less tear and less chance of damage. Our MDM Connector Saver is available in all eight standard MDM layouts. Mating hardware is also available and can be included with the original order, or it may be ordered separately.

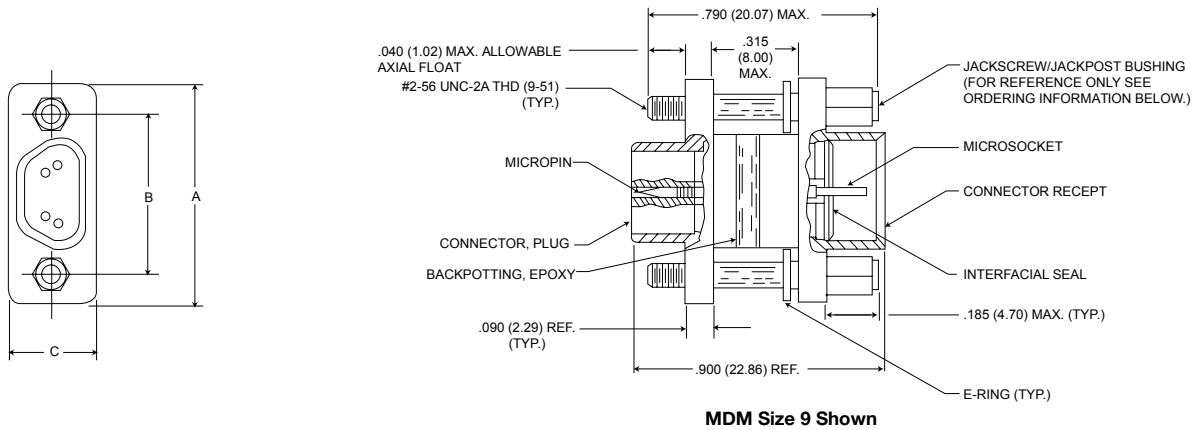

| Size | Electroless Nickel (A174) Plated | | Cadmium over Nickel (A101) Plated | | *Hardware Kits | A Max. | B ± .005 (0.13) | C Max. |
|------|----------------------------------|--------------|-----------------------------------|---------------|----------------|---------------|-----------------|--------------|
| | With Hardware | W/O Hardware | With Hardware | W/O Hardware | | | | |
| 9 | MDM98479-86 | MDM98479-18 | MDM98479-78 | MDM-97294-371 | 320-9505-014** | .785 (19.94) | .565 (14.35) | .308 (7.82) |
| 15 | MDM98479-87 | MDM98479-19 | MDM98479-79 | MDM-97294-372 | 320-9505-014** | .935 (23.75) | .715 (18.16) | .308 (7.82) |
| 21 | MDM98479-88 | MDM98479-20 | MDM98479-80 | MDM-97294-373 | 320-9505-014** | 1.085 (27.56) | .865 (21.97) | .308 (7.82) |
| 25 | MDM98479-89 | MDM98479-21 | MDM98479-81 | MDM-97294-374 | 320-9505-014** | 1.185 (30.10) | .965 (24.51) | .308 (7.82) |
| 31 | MDM98479-90 | MDM98479-14 | MDM98479-82 | MDM-97294-375 | 320-9505-014** | 1.335 (33.91) | 1.115 (28.32) | .308 (7.82) |
| 37 | MDM98479-91 | MDM98479-15 | MDM98479-83 | MDM-97294-376 | 320-9505-014** | 1.485 (37.72) | 1.265 (32.13) | .308 (7.82) |
| 51 | MDM98479-92 | MDM98479-16 | MDM98479-84 | MDM-97294-377 | 320-9505-014** | 1.435 (36.45) | 1.215 (30.86) | .351 (8.91) |
| 100 | MDM98479-93 | MDM98479-17 | MDM98479-85 | MDM-97294-717 | 320-9508-014** | 2.170 (55.12) | 1.800 (45.72) | .394 (10.01) |

* Kit contains 2 jackpost/jackscrew bushings and 2 E-Rings.
 ** Size 9-51-#2-56 UNC-2B Thread
 *** Size 100-#4-40 UNC-2B Thread



Dimensions shown in mm
 Specifications and dimensions subject to change

www.ittcannon.com

Micro-D Metal Shell - .050" Contact Spacing

MDM

Panel Cutouts

Shell Sizes 9 thru 51

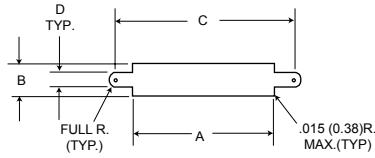

Figure 1
Front Mounting

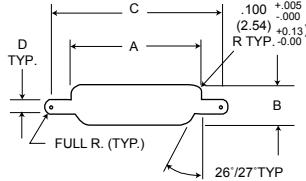

Figure 2
Rear Mounting

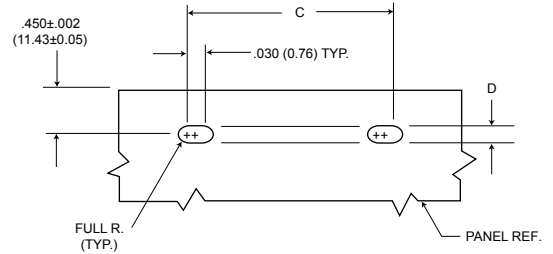

Figure 3
Edgeboard Mounting

Shell Size 100

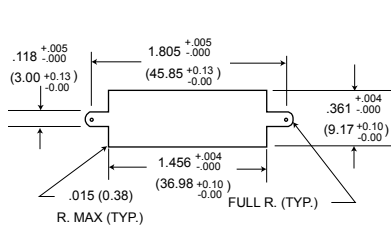

Figure 1
Front Mounting

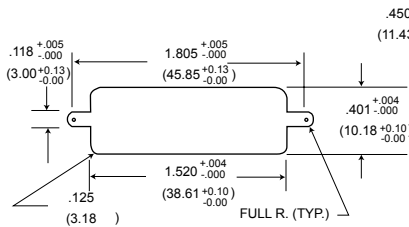

Figure 2
Rear Mounting

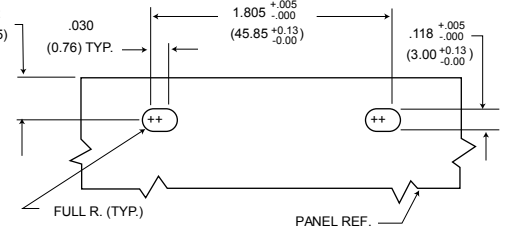

Figure 3
Edgeboard Mounting

For 9-51 Shell Sizes

NOTES:

1. Front panel mounting is the preferred mounting method. Front panel mounting dimensions (figure 1) will accommodate either #2-56 screws or jackpost hardware.
2. Rear panel mount dimensions (figure 2) will accommodate #2-56 screw hardware only. When mounting the connector with rear panel mount jackpost see the panel cut-out dimensions.
3. Edgeboard mounting bracket (figure 3) uses #2-56 screws. Dimension .450±.002 (11.43±0.05) locates the MDM receptacle flush with the end of the board.

For 100 Shell Size

NOTES:

1. Front mounting is the preferred mounting method. Front panel mounting dimensions (figure 1) will accommodate either #4-40 screws or jackpost hardware.
2. Rear panel mount dimensions (figure 2) will accommodate #4-40 screw hardware only see the panel cut-out dimensions.
3. Edgeboard mounting bracket (figure 3) uses #4-40 screws. Dimension .450±.002 (11.43±0.05) locates the MDM receptacle flush with the end of the board.

| Shell Size | Cutout Figure | A +.004 -.000 | B +.004 -.000 | C +.005 -.000 | D +.005 -.000 |
|------------|---------------|---------------------|---------------------|---------------------|---------------------|
| 9 | 1 | .408 | .271 | .570 | .089 |
| | 2 | .401 | .252 | .570 | .089 |
| | 3 | - | - | .570 | .089 |
| 15 | 1 | .558 | .271 | .720 | .089 |
| | 2 | .551 | .252 | .720 | .089 |
| | 3 | - | - | .720 | .089 |
| 21 | 1 | .708 | .271 | .870 | .089 |
| | 2 | .701 | .252 | .870 | .089 |
| | 3 | - | - | .870 | .089 |
| 25 | 1 | .808 | .271 | .970 | .089 |
| | 2 | .801 | .252 | .970 | .089 |
| | 3 | - | - | .970 | .089 |
| 31 | 1 | .958 | .271 | 1.120 | .089 |
| | 2 | .951 | .252 | 1.120 | .089 |
| | 3 | - | - | 1.120 | .089 |
| 37 | 1 | 1.108 | .271 | 1.270 | .089 |
| | 2 | 1.101 | .248 | 1.270 | .089 |
| | 3 | - | - | 1.270 | .089 |
| 51 | 1 | 1.058 | .315 | 1.220 | .089 |
| | 2 | 1.051 | .295 | 1.220 | .089 |
| | 3 | - | - | 1.220 | .089 |

Dimensions shown in mm

Specifications and dimensions subject to change

www.itccannon.com

Micro-D Metal Shell - .050" Contact Spacing

MDM

Mounting Hardware Views (sizes 9-51)

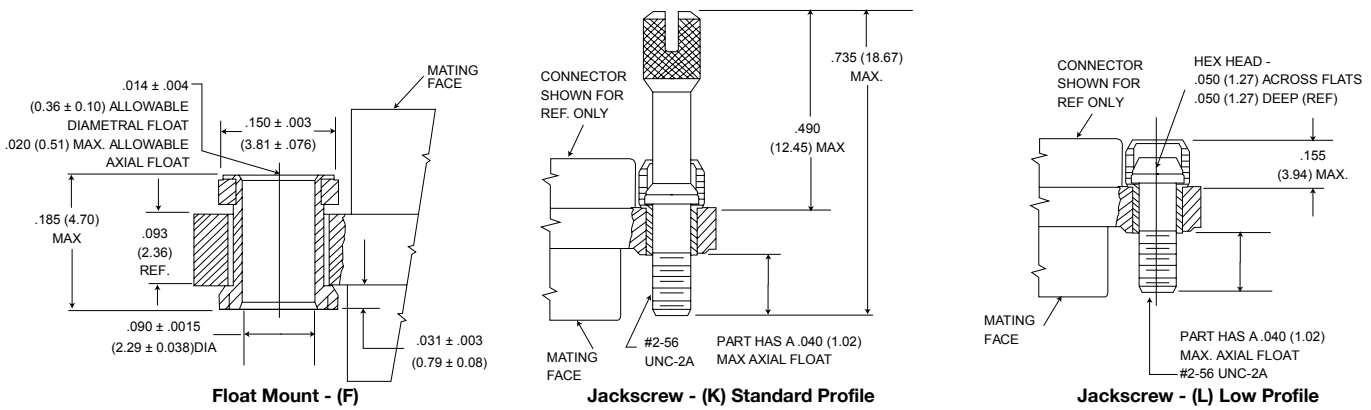

Shown here is a cutaway view of the float mount for the MDM connector. The basic shell dimensions are the same for the float mount and the screw mounting hole configurations. View shown is for standard float mount front panel mounting. Reverse mounting is available on request.

* NOTE: Torque values are as follows:
 Low Profile Jackscrew (L)-2.5 in-lbs
 Standard Jackscrew (K)-2.5 in-lbs

Mounting Hardware to Military Specification (for sizes 9 - 51) per MIL-DTL-83513/5

This hardware supplied in kits unassembled (2 pieces of each item).

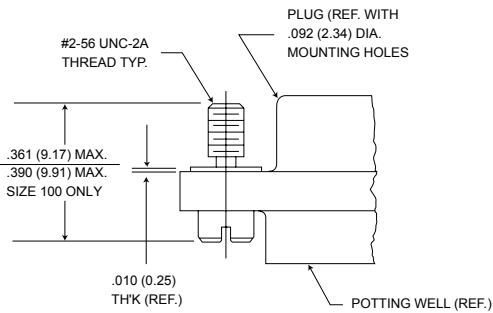

Figure 1. Jackscrew - Low profile Slotted Head Size 9-51 Size 100*

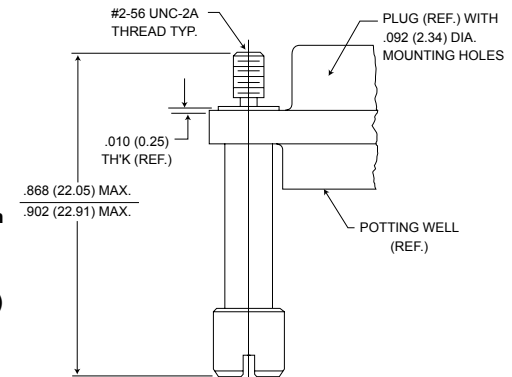
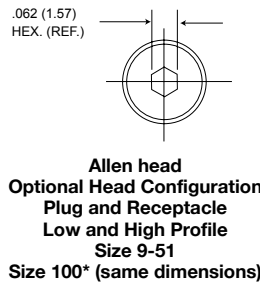

Figure 2. Jackscrew - High Profile Slotted Head Size 9-51 Size 100*

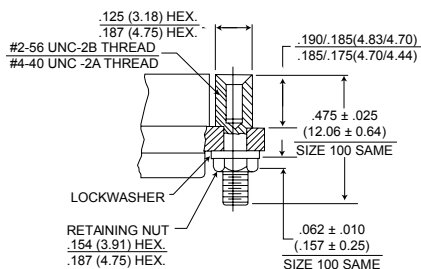

Figure 3. Jackpost Assembly Size 9-51 Size 100*

To order hardware kits separately, order either by M83513/5-** or by 320-950X-XXX.

| Description | Size 9-51 Mod Code Part Number | ** | Size 100* Mod Code Part Number | ** |
|--|--------------------------------|----|--------------------------------|----|
| Slotted Head Jackscrew Assy Low Profile (Figure 1) | M5 320-9508-025 | 05 | M15 320-9508-021 | 15 |
| Slotted Head Jackscrew Assy Low Profile (Figure 2) | M6 320-9508-027 | 06 | M16 320-9508-023 | 16 |
| Allen Head Jackscrew Assy Low Profile (Figure 1) | M2 320-9508-026 | 02 | M12 320-9508-022 | 12 |
| Allen Head Jackscrew Assy High Profile (Figure 2) | M3 320-9508-028 | 03 | M13 320-9508-024 | 13 |
| Jackpost Assy (Figure 3) | M7 320-9505-033 | 07 | M17 320-9505-030 | 17 |

*Size 100 requires B1 size mounting holes for Mil-Spec hardware

Note: Torque values as follows:
 Size 9-51 4.0 in-lbs
 Size 100 6.0 in-lbs



Dimensions shown in mm
 Specifications and dimensions subject to change

www.ittcannon.com

Micro-D Metal Shell - .050" Contact Spacing

MDM

Mounting Hardware Views for Front Panel Mount (for sizes 9-51)

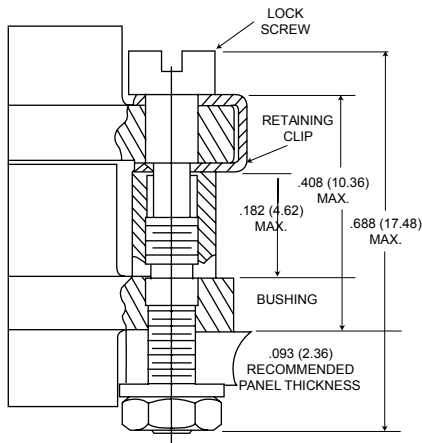

Screw Lock Assembly*
*NOTE Torque value is 2.5 in/lbs max.

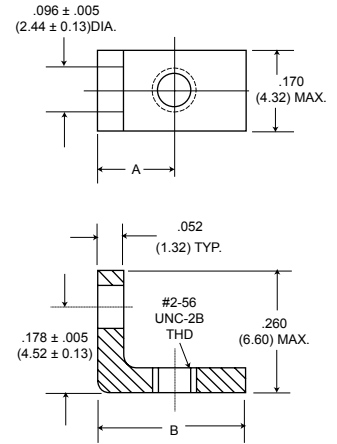
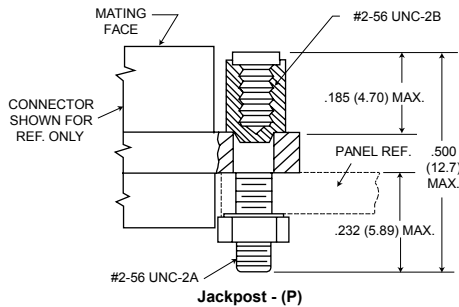

90° Angle Mounting Bracket

| Description | Part Number | A +/- .005 (±0.13) | B +/- .010 |
|--|--------------|-----------------------|---------------|
| Screw | 322-9500-000 | | N/A |
| Jackpost kit | 320-9505-000 | | N/A |
| Mounting Bracket 90° MDM for 9 thru 37 Shell Sizes | 015-9516-002 | .147 (3.73) | .277 (7.82) |
| Mounting Bracket 90° MDM for 51 Shell Size | 015-9516-003 | .169 (4.29) | .350 (8.89) |

NOTES: Screw lock assembly (322-9500-000) can be used for front mounting only. Jackpost kit (320-9505-000) consists of two assemblies, shipped unassembled.

Jackpost Bushing (for rear panel mounting-for sizes 9-51)

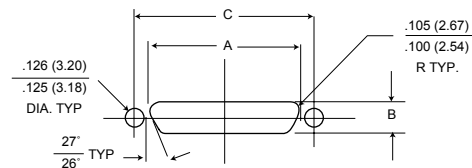
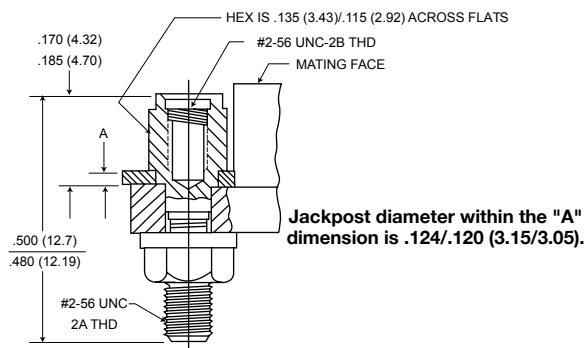

Plug and Receptacle Dimensions

| Panel A Thickness | A +.005 (0.13) -.000 (0.00) | Jackpost Kit Number* |
|-------------------|-----------------------------------|----------------------|
| 3/32 (2.4) | .087 (2.21) | 320-9505-007 |
| 1/16 (1.6) | .056 (1.42) | 320-9505-006 |
| 3/64 (1.2) | .042 (1.07) | 320-9505-005 |
| 1/32 (0.8) | .025 (0.64) | 320-9505-004 |

| Shell Size | A +.004 (0.10) -.000 (0.00) | B +.004 (0.10) -.000 (0.00) | C + .005 (0.13) |
|------------|-----------------------------------|-----------------------------------|--------------------|
| 9 | .401 (10.19) | .252 (6.40) | .565 (14.35) |
| 15 | .551 (14.00) | .252 (6.40) | .715 (18.16) |
| 21 | .701 (17.81) | .252 (6.40) | .865 (21.97) |
| 25 | .801 (20.34) | .252 (6.40) | .965 (24.51) |
| 31 | .951 (24.16) | .252 (6.40) | 1.115 (28.34) |
| 37 | 1.101 (27.97) | .252 (6.40) | 1.265 (32.13) |
| 51 | 1.051 (26.70) | .295 (7.49) | 1.215 (30.86) |

*A kit consists of 2 jackpost, 2 nuts, 2 washers.

Dimensions shown in mm
Specifications and dimensions subject to change

www.itccannon.com



Micro-D Metal Shell - .050" Contact Spacing

MDM

Mounting Hardware Views (for size 100)

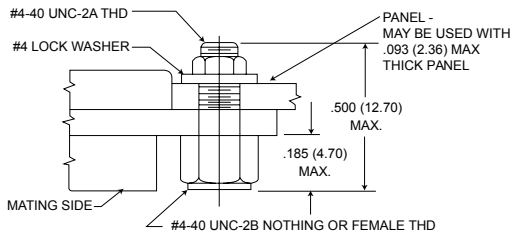

Jackpost - (P)

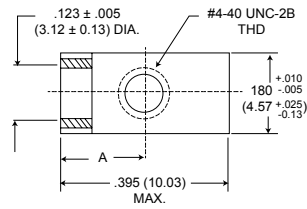

90° Angle Mounting Bracket

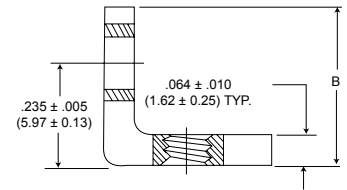

| Description | Part Number | A +/- .005 (±0.13) | B Max. |
|--|--------------|-----------------------|-------------|
| Screw | 322-9500-000 | | N/A |
| Jackpost kit | 320-9505-000 | | N/A |
| Mounting Bracket 90° MDM for 9 thru 37 Shell Sizes | 015-9516-002 | .147 (3.73) | .308 (7.82) |
| Mounting Bracket 90° MDM for 51 Shell Size | 015-9516-003 | .169 (4.29) | .350 (8.89) |

This hardware is factory installed.

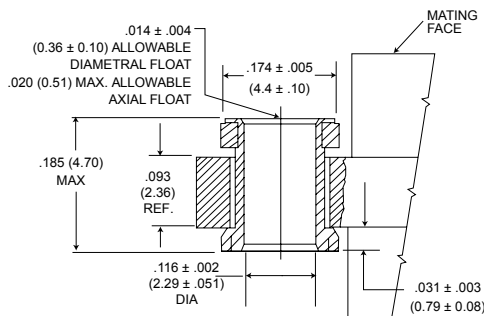

Float Mount - (F) Std.

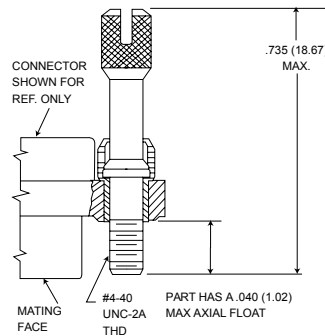

Jackscrew - (K) Standard

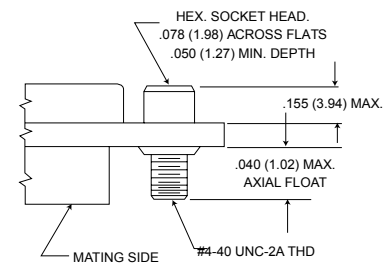

Jackscrew - (L) (Low Profile)

*NOTE: Torque values are as follows:
Low Profile Jackscrew (L)-4.0 in-lbs
Standard Profile Jackscrew (K)-4.0 in-lbs

Jackpost Bushing (for Rear Panel Mounting)

| Panel Thickness | A + .005 (0.13) - .000 (0.00) | Jackpost Kit Number* |
|-----------------|-------------------------------------|----------------------|
| 3/32 (2.4) | .087 (2.21) | 320-9505-013 |
| 1/16 (1.6) | .058 (1.42) | 320-9505-012 |
| 1/32 (0.8) | .025 (0.64) | 320-9505-010 |
| 3/64 (1.2) | .042 (1.07) | 320-9505-011 |

*2 jackposts, 2 nuts, 2 washers

Torque value for size 100

Note: Size 100 requires B mounting hole shell size when using rear panel mount jackposts

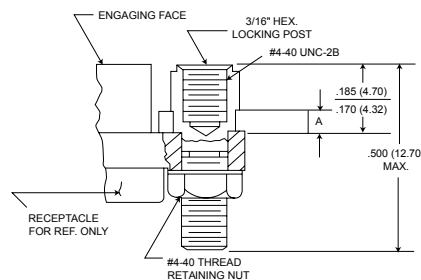

Dimensions for Rear Panel Mounting

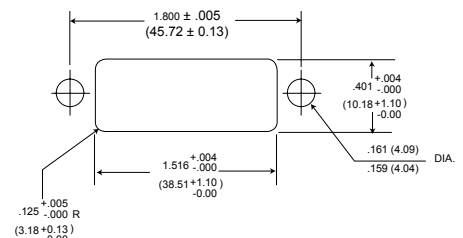

Dimensions shown in mm
Specifications and dimensions subject to change

www.ittcannon.com

Micro-D Coaxial/Power Combo - .050" Contact Spacing MDM



Cannon offers three options of the MDM Coaxial/Power Microminiature Connector:

MDM Coaxial: The MDM Metal Shell Connectors have been tooled in several coaxial layouts, offering the versatility of combining coaxial & signal lines in the same connector.

MDM Power: The same insulator used with coaxial contacts is available with power contacts, offering the versatility of combining power and signal lines in the same connector.

MDM Coaxial/Power: Power and coaxial contacts can be interchanged as desired.

How to Order (For MIL-DTL-83513 ordering information, see page 34 - 35)

R **MDM** - **51** **P** **H** **001** **P** - **XXX**

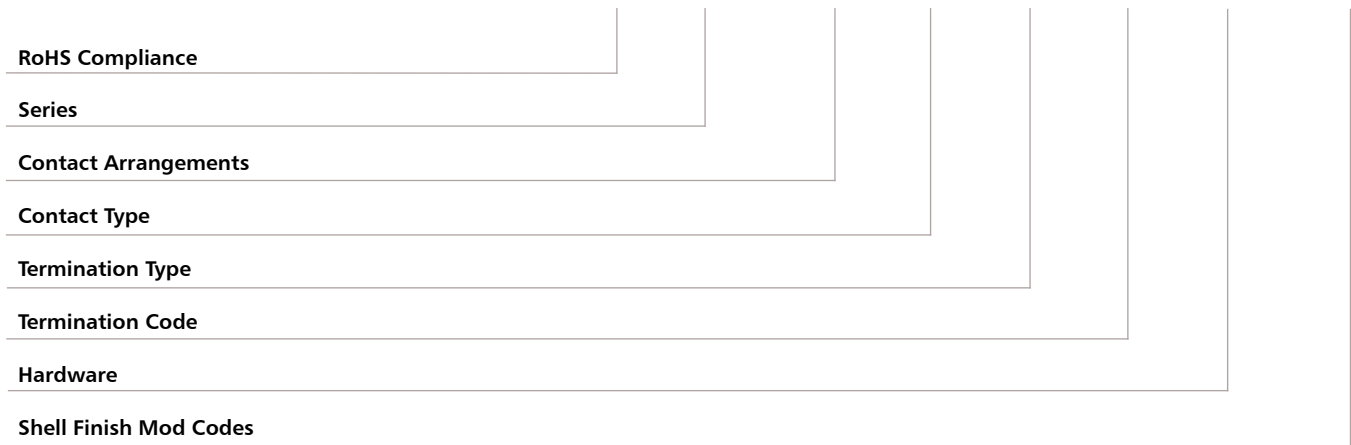

Series

MDM: (Size 9-100) Liquid Crystal Polymer (LCP)

Contact Arrangements

9-15-21-25-31-37-51-100 (standard)
 16C5, 10C10, 7C2, 24C4 (coaxial) } or combination of
 16P5, 10P10, 7P2, 24P4 (power) } coax and power

Contact Type

P - Pin S - Socket

Termination Type

H - Harness-insulated wire.
 L - Solid-uninsulated wire.
 S - Solder pot to accept #26 AWG MAX. harness wire.
 (Not available with power contact arrangements)

Hardware

M - Military specification hardware, see page 16
 for military hardware codes.
 P - Jackpost
 K - Jackscrew-standard profile
 L - Jackscrew-low profile
 F - Float mount
 B - No hardware standard.091 (2.31) dia. hole for
 sizes 9-51; .120 (3.05) dia. hole for size 100.
 A - .125 (3.18) dia. mounting holes for sizes 9-51; .166 (4.22) dia.
 hole for size 100.
 B1 - .1475 (3.75) dia. hole for size 100 (Per MIL-DTL-83513)

Termination code*

(H) 001 - 18", 7/34 strand, #26 AWG, MIL-W-16878/4,
 Type E Teflon, yellow.
 (H) 003 - 18", 7/34 strand, #26 AWG, MIL-W-16878/4,
 Type E Teflon, color
 coded to MIL-STD-681 System I.
 (L) 1 - 1/2" uninsulated solid #25 AWG gold plated copper.
 (L) 2 - 1" uninsulated solid #25 AWG gold plated copper.

Shell Finish Modification Codes

No Number - (Standard cadmium/yellow chromate over nickel)
 A174 - Electroless nickel
 A172 - Gold over nickel
 A141 - Irridite/alodine
 A30 - Black anodize



*See pp. 79-80 for additional termination codes.

Dimensions shown in mm
 Specifications and dimensions subject to change

www.ittcannon.com



Micro-D Coaxial/Power Combo - .050" Contact Spacing MDM-C/P

7C2/7P2

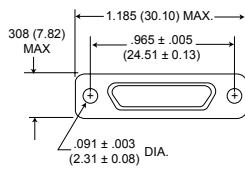

Plug

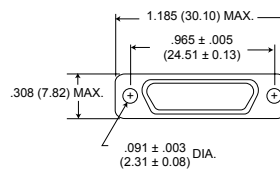
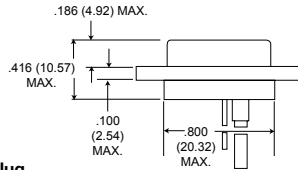

Receptacle

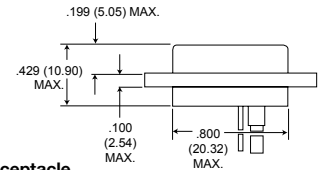

24C4/24P4

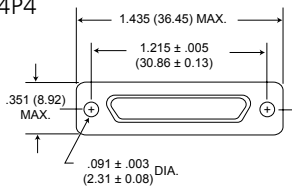

Plug

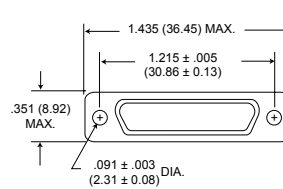
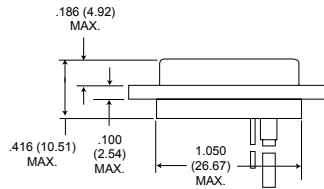

Receptacle

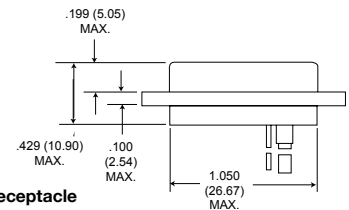

Power Contacts

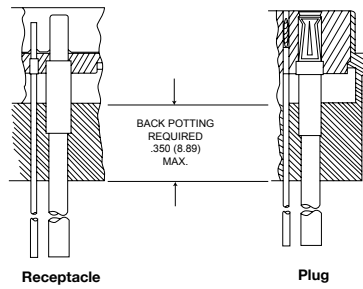

Coaxial Contacts

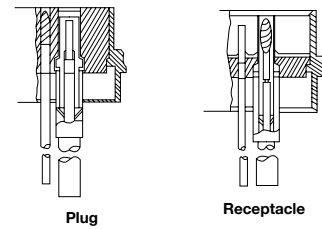

Micro-D PCB - .050" Contact Spacing

MDM-PCB



Our MDM-PCB Microminiature Connectors are designed for use with flex circuitry, flat cable and printed circuit boards or multi-layer boards. These interconnects use a standard MDM metal shell and provide high density and high reliability in board-to-board, board-to-cable and cable-to-cable applications. MDM PCB micro connectors are available in 8 shell sizes with 9 to 100 contacts. Terminations may be straight (BS) or at 90° right angle (BR, CBR) board thickness. Jackpost mounting for use with locking hardware is also available.

How to Order - MDM-PCB Series

| | | | | | | | | | | | | |
|---|---|-----|---|---|----|---|----|---|---|---|-----|------|
| | R | MDM | * | - | 25 | P | BS | P | - | T | L39 | A174 |
| RoHS Compliance | | | | | | | | | | | | |
| Series | | | | | | | | | | | | |
| Insulator Material | | | | | | | | | | | | |
| Contact Arrangements | | | | | | | | | | | | |
| Contact Type | | | | | | | | | | | | |
| Termination Type | | | | | | | | | | | | |
| Mounting Hardware (Shell Flange) | | | | | | | | | | | | |
| Mounting Hardware for PDB | | | | | | | | | | | | |
| Termination Tail Length Modification Code | | | | | | | | | | | | |
| Shell Finish Modification Codes | | | | | | | | | | | | |

Series

MDM - Micro "D" Metal Shell

Insulator Material

Liquid Crystal Polymer (LCP)

Contact Arrangements

9, 15, 21, 25, 31, 37, 51, and 100

Contact Type

P - Pin (Plug)

S - Socket (Receptacle)

Termination Type

BS - H Straight PCB Termination

BR - Right Angle PCB Termination

CBR - Right Angle Narrow

Profile PCB Terminations

CBS - Straight Narrow Profile

Mounting Hardware (Shell Flange)

P - Jackpost

R - Rear Panel Mount Jackpost

R1 - .032

R2 - .047

R3 - .062

R4 - .093

R5 - .125

M7 - Jackposts M83513/5-07 (Sizes 9-51)

M17 - Jackposts M83513/5-17 (Size 100)

No letter - none

Mounting Hardware for PCB

T - Threaded Insert (metal)

#2-56 Thd for Shell Sizes 9 thru 51

#4-40 Thd for Shell Size 100

No letter - none

Termination Tail Length Modification Code

None - .109 (2.77) ±.015 (0.38) Standard (solder dipped)

L61 - .125 (3.18)

L67 - .140

L56 - .150 (3.81)

L66 - .171

L57 - .190 (4.83)

L39 - .250 (6.35)

L58 - .375 (9.52)

Shell Finish Modification Codes

None - Yellow Chromate/Cadmium over Nickel

A174 - Electroless Nickel

A172 - Gold over Nickel

A141 - Irridite/Alodine

A30 - Black Anodize

(For special modification codes, consult customer service.)

NOTE: Back molding material – Epoxy Hysol #MG40FS



Micro-D PCB - .050" Contact Spacing

MDM-PCB

BS (Board Straight) Series

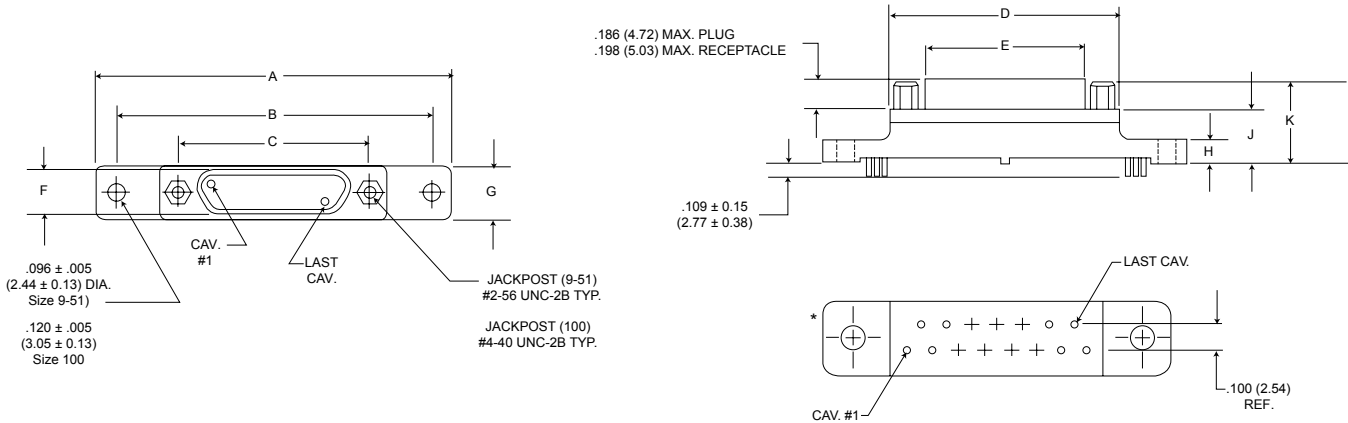

PCB Termination Arrangements* (Viewed from PCB solder side)

Identification number shown for plug connector, use reverse order for socket connector.

NOTE: Dimensions shown are for reference only-consult factory for final design dimensions.

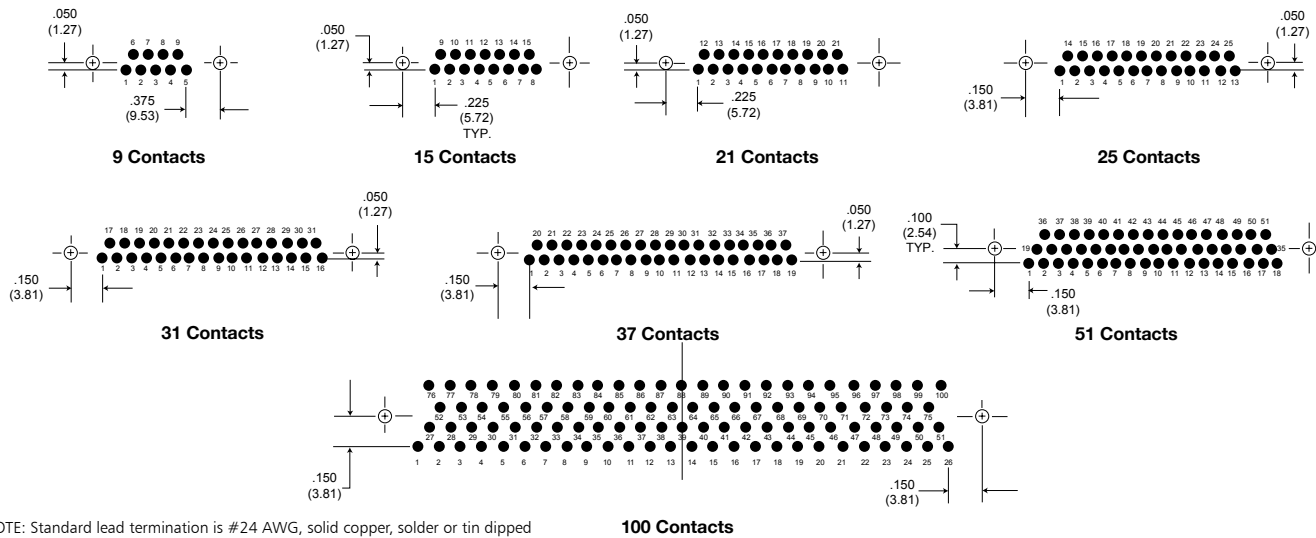

NOTE: Standard lead termination is #24 AWG, solid copper, solder or tin dipped
All Termination Configurations .100 (2.54) x .100 (2.54) Grid Pattern, Offset .050 (1.27)

| Part Number By Shell Size | A Max. | B ±.007 (.18) | C ±.005 (.13) | D Max. | E Max. | F Max. | G Max. | H Max. | J Max. | K Max. |
|------------------------------|---------------|------------------|------------------|---------------|---------------|--------------|--------------|-------------|--------------|--------------|
| MDM-9PBS* | 1.390 (35.31) | 1.150 (29.21) | .565 (14.35) | .785 (19.94) | .334 (8.48) | .185 (4.70) | .308 (7.82) | .165 (4.19) | .355 (9.02) | .555 (14.10) |
| MDM-9SBS* | 1.390 (35.31) | 1.150 (29.21) | .565 (14.35) | .785 (19.94) | .402 (10.21) | .253 (6.43) | .308 (7.82) | .165 (4.19) | .355 (9.02) | .555 (14.10) |
| MDM-15PBS* | 1.390 (35.31) | 1.150 (29.21) | .715 (18.16) | .935 (23.75) | .484 (12.29) | .185 (4.70) | .308 (7.82) | .165 (4.19) | .355 (9.02) | .555 (14.10) |
| MDM-15SBS* | 1.390 (35.31) | 1.150 (29.21) | .715 (18.16) | .935 (23.75) | .552 (13.97) | .253 (6.43) | .308 (7.82) | .165 (4.19) | .355 (9.02) | .555 (14.10) |
| MDM-21PBS* | 1.690 (43.93) | 1.450 (36.83) | .865 (21.97) | 1.085 (27.56) | .634 (16.10) | .185 (4.70) | .308 (7.82) | .165 (4.19) | .355 (9.02) | .555 (14.10) |
| MDM-21SBS* | 1.690 (43.93) | 1.450 (36.83) | .865 (21.97) | 1.085 (27.56) | .702 (17.83) | .253 (6.43) | .308 (7.82) | .165 (4.19) | .355 (9.02) | .555 (14.10) |
| MDM-25PBS | 1.740 (44.20) | 1.500 (38.10) | .965 (24.51) | 1.185 (30.10) | .734 (18.64) | .185 (4.70) | .308 (7.82) | .165 (4.19) | .355 (9.02) | .555 (14.10) |
| MDM-25SBS* | 1.740 (44.20) | 1.500 (38.10) | .965 (24.51) | 1.185 (30.10) | .802 (20.37) | .253 (6.43) | .308 (7.82) | .165 (4.19) | .355 (9.02) | .555 (14.10) |
| MDM-31PBS* | 2.040 (51.82) | 1.800 (45.72) | 1.115 (28.32) | 1.335 (33.91) | .884 (22.45) | .185 (4.70) | .308 (7.82) | .165 (4.19) | .355 (9.02) | .555 (14.10) |
| MDM-31SBS* | 2.040 (51.82) | 1.800 (45.72) | 1.115 (28.32) | 1.335 (33.91) | .952 (24.18) | .253 (6.43) | .308 (7.82) | .165 (4.19) | .355 (9.02) | .555 (14.10) |
| MDM-37PBS* | 2.340 (59.44) | 2.100 (53.34) | 1.265 (32.13) | 1.485 (37.72) | 1.034 (26.26) | .185 (4.70) | .308 (7.82) | .165 (4.19) | .355 (9.02) | .555 (14.10) |
| MDM-37SBS* | 2.340 (59.44) | 2.100 (53.34) | 1.265 (32.13) | 1.485 (37.72) | 1.102 (27.99) | .253 (6.43) | .308 (7.82) | .165 (4.19) | .355 (9.02) | .555 (14.10) |
| MDM-51PBS* | 2.270 (67.66) | 2.000 (50.80) | 1.215 (30.86) | 1.435 (36.45) | .984 (24.99) | .228 (5.79) | .351 (8.92) | .165 (4.19) | .355 (9.02) | .555 (14.10) |
| MDM-51SBS* | 2.270 (67.66) | 2.000 (50.80) | 1.215 (30.86) | 1.435 (36.45) | 1.052 (26.72) | .296 (7.52) | .351 (8.92) | .165 (4.19) | .355 (9.02) | .555 (14.10) |
| MDM-100PBS* | 3.070 (77.98) | 2.800 (71.12) | 1.800 (45.72) | 2.175 (55.24) | 1.384 (35.15) | .271 (6.88) | .460 (11.68) | .303 (7.70) | .550 (12.70) | .686 (17.42) |
| MDM-100SBS* | 3.070 (77.98) | 2.800 (71.12) | 1.800 (45.72) | 2.175 (55.24) | 1.508 (38.30) | .394 (10.01) | .460 (11.68) | .303 (7.70) | .550 (12.70) | .686 (17.42) |

*For jackpost, add letter "P" or "M7" for sizes 9-51, "M17" for size 100.



Dimensions shown in mm
Specifications and dimensions subject to change

www.ittcannon.com

Micro-D PCB - .050" Contact Spacing

MDM-PCB

BR (Board Right Angle) Series

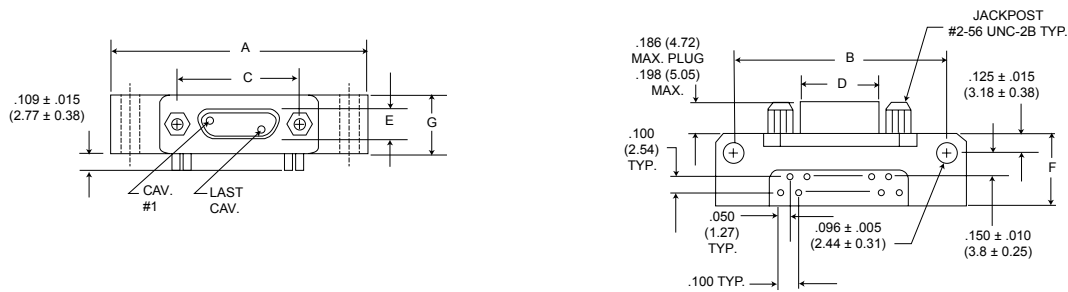

PCB Termination Arrangements (Viewed from bottom of connector, PCB solder side.)

Identification number shown for plug connector, use reverse order for socket connector.

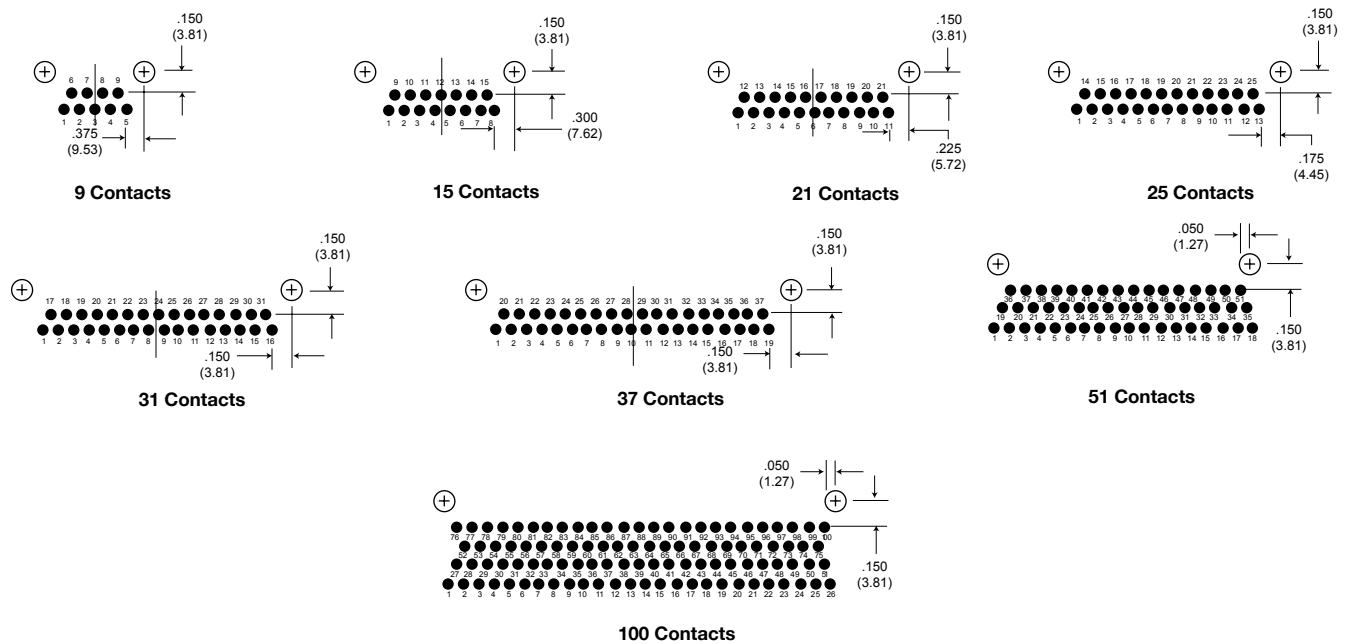

NOTE: Standard lead termination is #24 AWG, gold plated, solid copper, solder or tin dripped.

All Termination Configurations .100 (2.54) x .100 (2.54) Grid Pattern, Offset .050 (1.27).

| Part Number By Shell Size | A Max. | B ± .007 (.18) | C ± .005 (.13) | D Max. | E Max. | F Max. | G Max. |
|------------------------------|---------------|-------------------|-------------------|---------------|--------------|--------------|--------------|
| MDM-9PBR* | 1.390 (35.31) | 1.150 (29.21) | .565 (14.35) | .334 (8.48) | .185 (4.70) | .455 (11.56) | .308 (7.82) |
| MDM-9SBR* | 1.390 (35.31) | 1.150 (29.21) | .565 (14.35) | .402 (10.21) | .253 (6.43) | .455 (11.56) | .308 (7.82) |
| MDM-15PBR* | 1.540 (39.12) | 1.300 (33.02) | .715 (18.16) | .484 (12.29) | .185 (4.70) | .455 (11.56) | .308 (7.82) |
| MDM-15SBR* | 1.540 (39.12) | 1.300 (33.02) | .715 (18.16) | .552 (13.97) | .253 (6.43) | .455 (11.56) | .308 (7.82) |
| MDM-21PBR* | 1.690 (42.93) | 1.450 (36.83) | .865 (21.97) | .634 (16.10) | .185 (4.70) | .455 (11.56) | .308 (7.82) |
| MDM-21SBR* | 1.690 (42.93) | 1.450 (36.83) | .865 (21.97) | .702 (17.83) | .253 (6.43) | .455 (11.56) | .308 (7.82) |
| MDM-25PBR* | 1.790 (45.47) | 1.550 (39.37) | .965 (24.51) | .734 (18.64) | .185 (4.70) | .455 (11.56) | .308 (7.82) |
| MDM-25SBR* | 1.790 (45.47) | 1.550 (39.37) | .965 (24.51) | .802 (20.37) | .253 (6.43) | .455 (11.56) | .308 (7.82) |
| MDM-31PBR* | 2.040 (51.82) | 1.800 (45.72) | 1.115 (28.32) | .884 (22.45) | .185 (4.70) | .455 (11.56) | .308 (7.82) |
| MDM-31SBR* | 2.040 (51.52) | 1.800 (45.72) | 1.115 (28.32) | .952 (24.18) | .253 (6.43) | .455 (11.56) | .308 (7.82) |
| MDM-37PBR* | 2.340 (59.44) | 2.100 (53.34) | 1.265 (32.13) | 1.034 (26.26) | .185 (4.70) | .455 (11.56) | .308 (7.82) |
| MDM-37SBR* | 2.340 (59.44) | 2.100 (53.34) | 1.265 (32.13) | 1.102 (27.99) | .253 (6.43) | .455 (11.56) | .308 (7.82) |
| MDM-51PBR* | 1.875 (47.63) | 1.600 (40.64) | 1.215 (30.86) | .984 (24.99) | .228 (5.79) | .565 (14.35) | .351 (8.92) |
| MDM-51SBR* | 1.875 (47.63) | 1.600 (40.64) | 1.215 (30.86) | 1.052 (26.72) | .296 (7.52) | .565 (14.35) | .351 (8.92) |
| MDM-100PBR* | 2.74 (69.72) | 2.500 (63.50) | 1.800 (45.72) | 1.384 (35.15) | .271 (6.88) | .755 (19.18) | .394 (10.01) |
| MDM-100SBR* | 2.74 (69.72) | 2.500 (63.50) | 1.800 (45.72) | 1.508 (38.10) | .394 (10.01) | .755 (19.18) | .394 (10.01) |

*For jackpost, add letter "P" or "M7" for sizes 9-51, "M17" for size 100.

*Add lead type and length; see How To Order.

Dimensions shown in mm

Specifications and dimensions subject to change

www.itccannon.com



Micro-D PCB - .050" Contact Spacing

MDM-PCB

CBR (Condensed Board Right Angle) Series

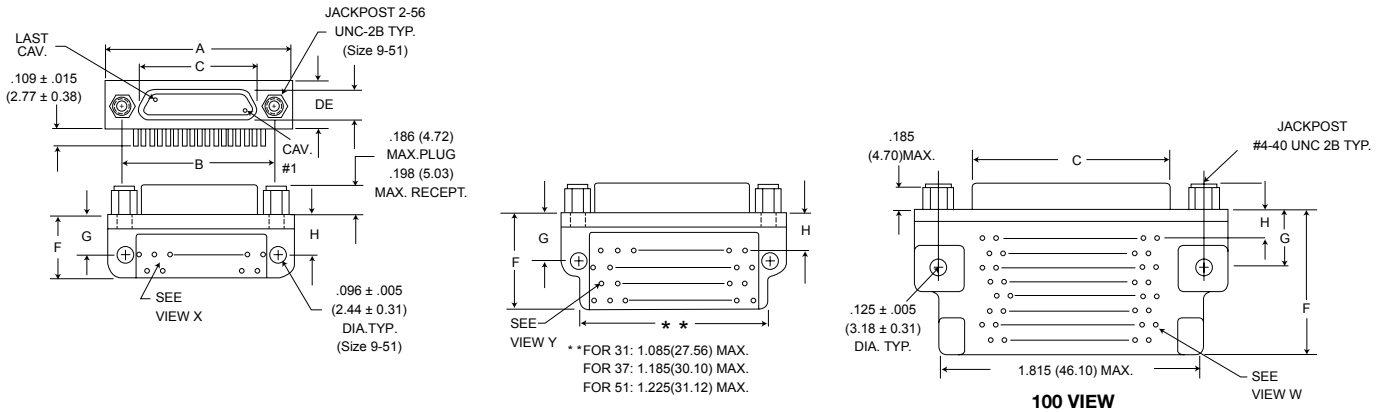

PCB Termination Arrangements (Viewed from bottom of connector, PCB solder side.)

Identification number shown for plug connector, use reverse order for socket connector.

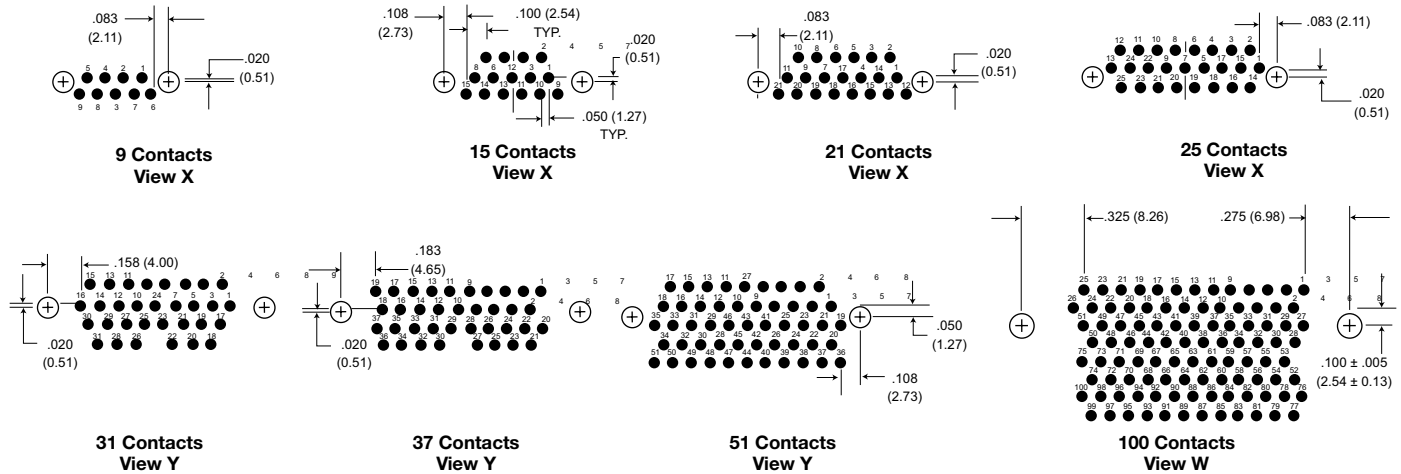

All Termination Configurations .100 (2.54) x .100 (2.54) Grid Pattern, Offset .050 (1.27).

NOTE: Standard lead termination is #24 AWG, solid copper, solder or tin dripped.

| Part Number By Shell Size | A Max. | B ± .005 (.13) | C Max. | D Max. | E Max. | F Max. | G ± .010 (.25) | H ± .010 (.25) |
|---------------------------|---------------|----------------|---------------|--------------|--------------|---------------|----------------|----------------|
| MDM-9PCBR* | .785 (19.94) | .565 (14.35) | 334 (8.48) | 308 (7.82) | .185 (4.70) | 420 (10.67) | .250 (6.35) | .230 (5.81) |
| MDM-9SCBR* | .785 (19.94) | .565 (14.35) | .402 (10.21) | .308 (7.82) | .253 (6.43) | .420 (10.67) | .250 (6.35) | .230 (5.81) |
| MDM-15PCBR* | .935 (23.75) | .715 (18.16) | .484 (12.29) | .308 (7.82) | .185 (4.70) | .420 (10.67) | .250 (6.35) | .130 (3.30) |
| MDM-15SCBR* | .935 (23.75) | .715 (18.16) | .552 (13.97) | .308 (7.82) | .253 (6.43) | .420 (10.67) | .250 (6.35) | .130 (3.30) |
| MDM-21PCBR* | 1.085 (27.56) | .865 (21.97) | .634 (16.10) | .308 (7.82) | .185 (4.70) | .420 (10.67) | .250 (6.35) | .130 (3.30) |
| MDM-21SCBR* | 1.085 (27.56) | .865 (21.97) | .702 (17.83) | .308 (7.82) | .253 (6.43) | .420 (10.67) | .250 (6.35) | .130 (3.30) |
| MDM-25PCBR* | 1.185 (30.10) | .965 (24.51) | .734 (18.64) | .308 (7.82) | .184 (4.70) | .420 (10.67) | .250 (6.35) | .130 (3.30) |
| MDM-25SCBR* | 1.185 (30.10) | .965 (24.51) | .802 (20.37) | .308 (7.82) | .253 (6.43) | .420 (10.67) | .250 (6.35) | .130 (3.30) |
| MDM-31PCBR* | 1.335 (33.91) | 1.115 (28.32) | .884 (22.45) | .308 (7.82) | .185 (4.70) | .520 (13.21) | .250 (6.35) | .130 (3.30) |
| MDM-31SCBR* | 1.335 (33.91) | 1.115 (28.32) | .952 (24.18) | .308 (7.82) | .253 (6.43) | .520 (13.21) | .250 (6.35) | .130 (3.30) |
| MDM-37PCBR* | 1.485 (37.72) | 1.265 (32.13) | 1.034 (26.26) | .308 (7.82) | .185 (4.70) | .520 (13.21) | .250 (6.35) | .130 (3.30) |
| MDM-37SCBR* | 1.485 (37.72) | 1.265 (32.13) | 1.102 (27.99) | .308 (7.82) | .253 (6.43) | .520 (13.21) | .250 (6.35) | .130 (3.30) |
| MDM-51PCBR* | 1.435 (36.45) | 1.215 (30.86) | .984 (24.99) | .351 (8.92) | .228 (5.79) | .650 (16.15) | .300 (7.62) | .150 (3.81) |
| MDM-51SCBR* | 1.435 (36.45) | 1.215 (30.86) | 1.052 (26.72) | .351 (8.92) | .296 (7.52) | .650 (16.15) | .300 (7.62) | .150 (3.81) |
| MDM-100PCBR* | 2.170 (55.12) | 1.800 (45.72) | 1.384 (35.15) | .394 (10.01) | .271 (6.88) | 1.000 (25.40) | .400 (10.16) | .200 (5.08) |
| MDM-100SCBR* | 2.170 (55.12) | 1.800 (45.72) | 1.508 (38.10) | .394 (10.01) | .394 (10.01) | 1.000 (25.40) | .400 (10.16) | .200 (5.08) |

*For jackpost, add letter "P" or "M7" for sizes 9-51, "M17" for size 100.



Dimensions shown in mm
Specifications and dimensions subject to change

www.ittcannon.com

Micro-D Metal Shell Low Profile 0.50" Spacing

MDLM



Our Micro-D Metal Shell Low Profile Connectors offer the flexibility and small profile that today's electronics systems demand. Using the dielectric footprint of Cannon's MD Series Connector and an aluminum shell designed to be a thinner, lower profile package, ITT Cannon engineers have developed a connector family that meets all of the performance criteria of the Cannon MDM and MIL-DTL-83513 Connectors. The Micro-D Metal Shell Low Profile Series is available in standard cable plugs and receptacles in contact sizes 9 through 51 positions. This family of connectors, like the original MDM series, features Cannon Twist Pin Contact Technology on 0.050 inch spacing.

Component Materials & Finishes

| | |
|---------------------------|--|
| Material | 6061-T6 Aluminum Alloy per QQ-A-200/8 |
| Finishes (-A174) | Electroless nickel plate per SAE-AMS-C-26074, Class 4m .001-.0015 inch thick |
| Insulators (9-51) | Liquid Crystalline Polymer per MIL-M-24519, Type GLCP-30F |
| Contacts | Gold Plate per MIL-DTL-45204 .000050 inch thick min over Copper Alloy per SAE-AMS-2418 .000010 inch thick min. |
| Hardware | 300 Series stainless steel, passivated |
| Float Mount Washer | 400 Series stainless steel, passivated |
| Standard Epoxy | Hysol EE4215/HD3561, color: black |

Mechanical Features

| | |
|--------------------------------|-----------------------------------|
| Coupling | Friction/Jackscrews |
| Polarization | Keystone-shaped shells |
| Contact Spacing Centers | .050 (1.27) |
| No. of Contacts | 9 thru 51 signal |
| Wire Size (Standard) | #25 Solid Wire, #26 Standard Wire |
| Contact Termination | Multiple indent crimp |

| Test | Method | Criteria of Acceptance |
|---------------------------------|--|---|
| Dielectric Withstanding Voltage | Method 3001: 600 VAC at sea level 150 VAC at 70,000 altitude | No breakdown No breakdown |
| Insulation Resistance | Method 3003 | 5,000 megaohms minimum |
| Thermal Shock | Method 1003, condition A: -55° C to +125° C | No physical damage |
| Physical Shock | Method 2004, Condition E: 50 G's, 3 axes, 6 milliseconds duration sawtooth pulse | No physical damage no loss of continuity > 1 μsec |
| Vibration | Method 2005, Condition IV: 20 G's, 10-2,000 Hz. 12 hrs. | No physical damage no loss of continuity > 1 μsec |
| Durability | 500 cycles of mating and unmating, 500 CPH max | No mechanical or electrical defects |
| Moisture Resistance | Method 1002, Type II, omit steps 7a and 7b | Insulation resistance > 100 megaohms |
| Salt Spray | Method 1001, Condition B: 48 Hours | Shall be capable of mating and unmating, and meet contact resistance requirements |
| Contact Resistance MIL-STD-202 | Method 1001, Condition B: at 3 amps at 1 milliamp | 8 milliohms maximum 10 milliohms maximum |
| Contact Retention | Per MIL-DTL-85313 | 5 lb. minimum axial load |

Dimensions shown in mm
Specifications and dimensions subject to change

www.ittcannon.com



Micro-D Metal Shell Low Profile 0.50" Spacing

MDLM

How to Order | Part Number Nomenclature – Slash Sheets 1-5, 10-27



MDLM - **25** **P** **6** **P** **Y** **18** **L** - **A174**

Series
MDLM - MDM Low Profile

Contact Arrangement
9, 15, 21, 25, 31, 37 & 51

Contract Type
P - Pin
S - Socket

Wire Gauge (AWG)
4 - #24 Gauge
6 - #26 Gauge (Standard)
8 - #28 Gauge
0 - #30 Gauge

Wire Type
P - Teflon(PTFE) Wire Per MIL-W-16878/4 (Standard)
T - Teflon(TFE) Wire Per MIL-W-22759/11
E - Cross-Linked Tefzel(ETFE) Wire Per MIL-W-22759/33
C - Custom Wiring

Wire Colour
W - White
Y - Yellow (Standard)
S - Color Coded per MIL-STD-681, System 1
T - Ten Color Repeat
C - Custom Wire Coloring

Overall Wire Length (Inches)
1 Inch Minimum and Must be Rounded to the Nearest Whole Inch
Examples:

- 5 - 5 inches
- 18 - 18 inches
- 50 - 50 inches
- 120 - 120 inches
- C - Custom Wire Lengths

Hardware

| | | |
|---|---------------------------|---|
| B | - No hardware, Ø.091 Hole | Military Specification Hardware |
| A | - No hardware, Ø.125 Hole | M2 - Jackscrew-low profile (Allen Head) |
| P | - Jackpost | M3 - Jackscrew-standard profile (Allen Head) |
| K | - Jackscrew-Standard | M5 - Jackscrew-low profile (Slotted Head) |
| L | - Jackscrew-Low Profile | M6 - Jackscrew-standard profile (Slotted Head) |
| F | - Float Mount | M7 - Jackpost |

Shell Finish/Mod Codes
No
Number- Electroless Nickel (RoHS Compliant)
A101 - Yellow Chromate/Cadmium over Nickel (Not RoHS Compliant)
A172 - Gold over Nickel (RoHS Compliant)
A141 - Irridite/Alodine (RoHS Compliant)
A30 - Black Anodize (RoHS Compliant)
(Consult Factory for all other Mod Codes)



Dimensions shown in mm
Specifications and dimensions subject to change

www.ittcannon.com

Micro-D Metal Shell Low Profile 0.50" Contact Spacing MDLM

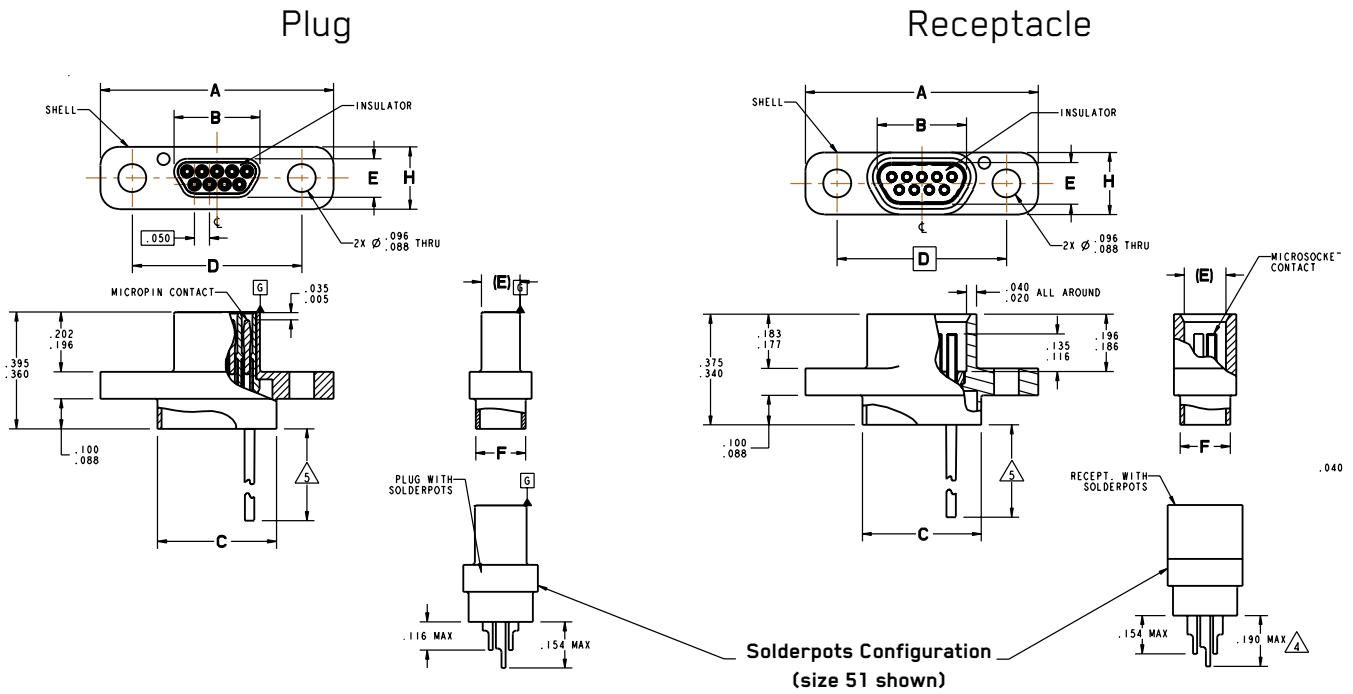

| Size | Plug Dimensions | | | | | | |
|------|-----------------|-----------|--------------|-------|-----------|-------------|-----------|
| | A ± .010 | B Max. | C +10/-18 | D | E Max. | F ± .010 | H Max. |
| -9P | .778 | .2918 | .398 | .565 | .1338 | .173 | .208 |
| -15P | .928 | .4418 | .548 | .715 | | | |
| -21P | 1.078 | .5918 | .698 | .865 | | | |
| -25P | 1.178 | .6918 | .798 | .965 | | | |
| -31P | 1.328 | .8418 | .948 | 1.115 | | | |
| -37P | 1.478 | .9918 | 1.098 | 1.265 | | | |
| -51P | 1.428 | .9418 | 1.048 | 1.215 | .1768 | .220 | .250 |

| Size | Receptacle Dimensions | | | | | | |
|------|-----------------------|-----------|--------------|-------|-----------|-------------|-----------|
| | A ± .010 | B Max. | C +10/-18 | D | E Max. | F ± .010 | H Max. |
| -9S | .778 | .2922 | .398 | .565 | .1342 | .173 | .208 |
| -15S | .928 | .4222 | .548 | .715 | | | |
| -21S | 1.078 | .5922 | .698 | .865 | | | |
| -25S | 1.178 | .6922 | .798 | .965 | | | |
| -31S | 1.328 | .8422 | .948 | 1.115 | | | |
| -37S | 1.478 | .9922 | 1.098 | 1.265 | | | |
| -51S | 1.428 | .9422 | 1.048 | 1.215 | .1772 | .220 | .250 |

Dimensions shown in mm
 Specifications and dimensions subject to change

Micro-D Metal Shell Low Profile 0.50" Contact Spacing MDLM

Standard Layouts

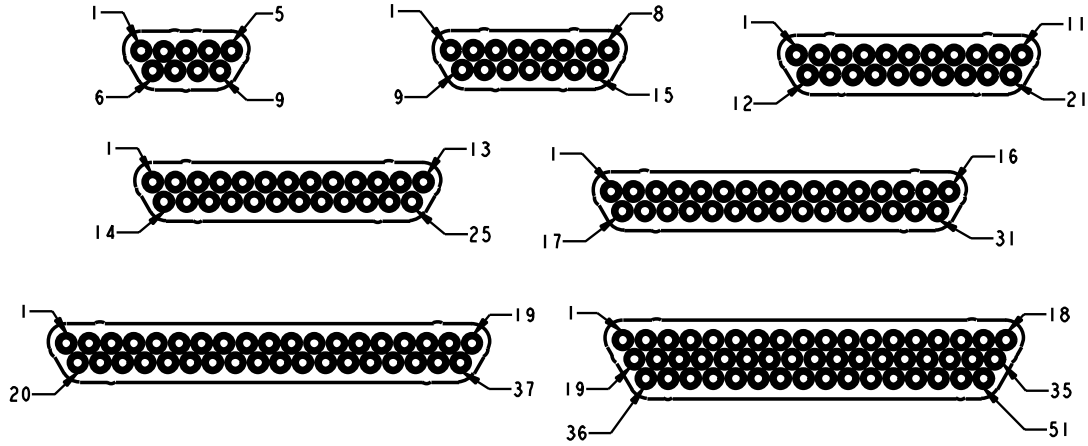

Panel Cutouts

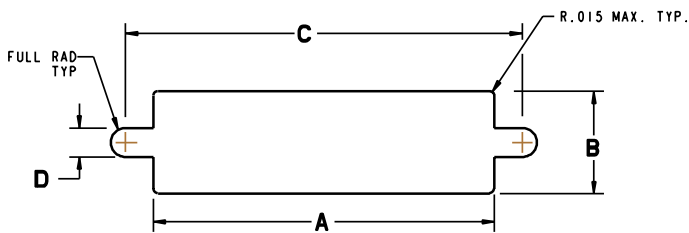

Front Mounting (Preferred)

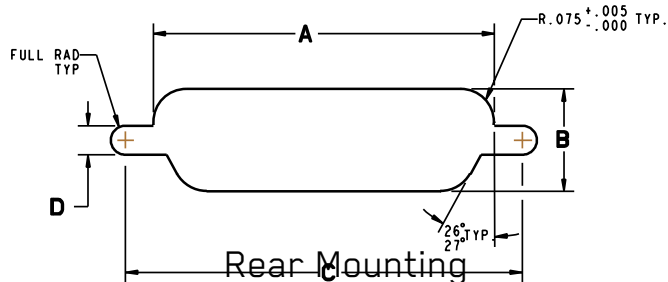

Rear Mounting

| Cutout Dimensions | | | | | |
|-------------------|----------------|-------|------|-------|------|
| Shell Size | Cutout Config. | A | B | C | D |
| -9 | Front | .409 | .172 | .570 | .089 |
| | Rear | .379 | .219 | | |
| -15 | Front | .559 | .172 | .720 | |
| | Rear | .529 | .219 | | |
| -21 | Front | .709 | .172 | .870 | |
| | Rear | .679 | .219 | | |
| -25 | Front | .809 | .172 | .970 | |
| | Rear | .779 | .219 | | |
| -31 | Front | .959 | .172 | 1.120 | |
| | Rear | .929 | .219 | | |
| -37 | Front | 1.109 | .172 | 1.270 | |
| | Rear | 1.079 | .219 | | |
| -51 | Front | 1.059 | .215 | 1.220 | |
| | Rear | 1.029 | .261 | | |

Micro-D Metal Shell Low Profile 0.50" Contact Spacing MDLM

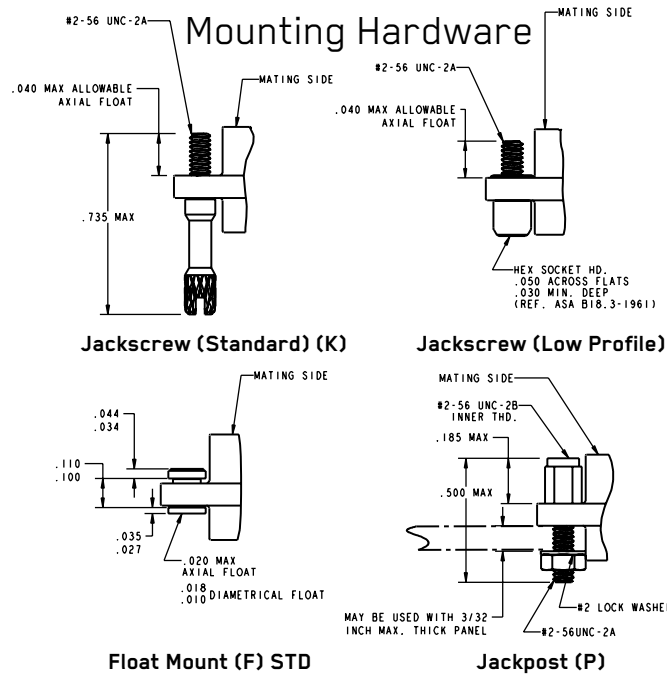

Recommended American Standard Machine Screws for Connector Float Mounting

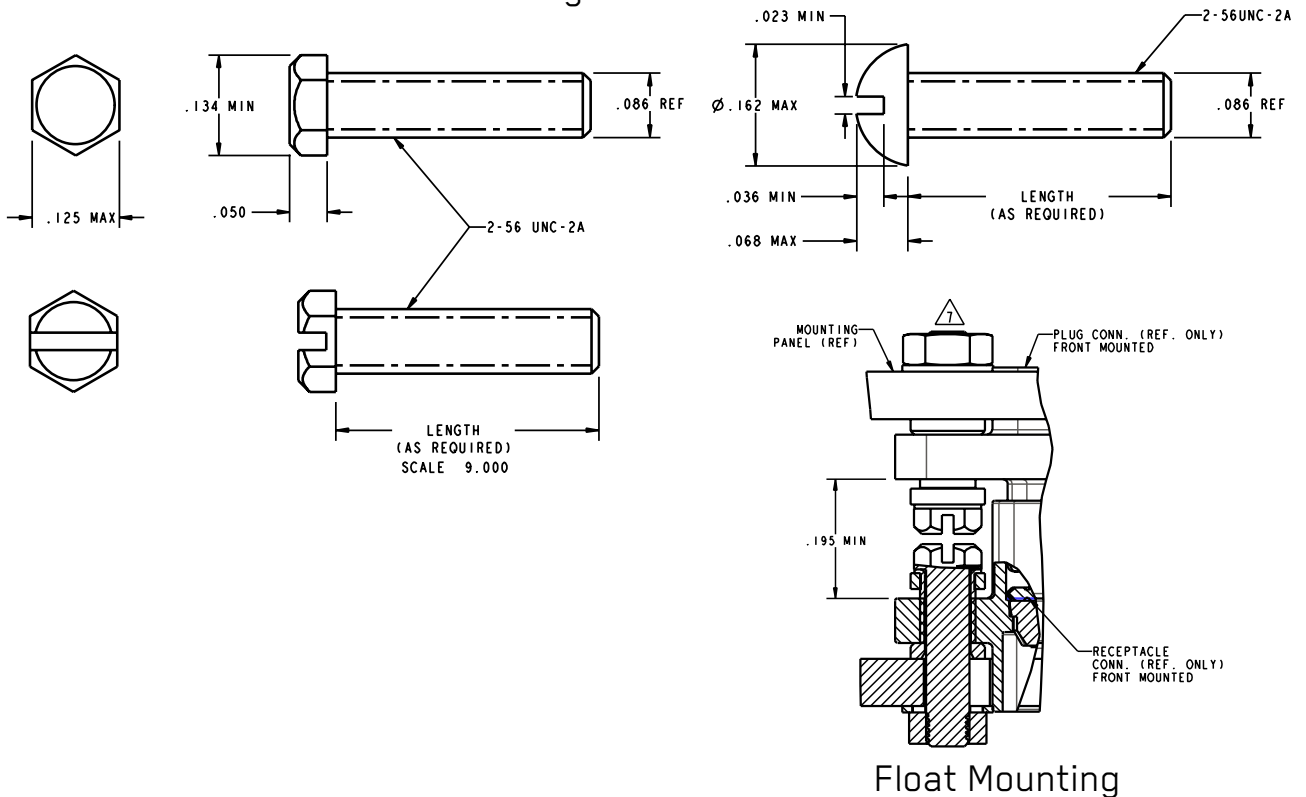

Dimensions shown in mm
Specifications and dimensions subject to change

www.ittcannon.com

200°C High Temp Micro-D

MDM-F222



With the increasing demand for more ruggedized interconnect solutions that can withstand extreme temperatures and operating conditions, our High Temp Micro-MDM F222 leads the industry with exceptional versatility and performance. This highly engineered, highly reliable microminiature interconnect features Cannon Micro Twist Pin Technology and is qualification tested to withstand 200°C continuous operating temperature for 500 hours.

Specifications & Options for 200°C High Temp Micro-MDM F222

Configurations

- Terminations
 - Stranded wire
 - Solid wire
 - Solder pots
 - PCB
- Straight
- Right angle
- Condensed right angle
- Signal contacts: 9, 15, 21, 25, 31, 37, 51, 100

Electrical Wire Size

- Stranded wire:
 - 24 AWG thru 32 AWG
- Solid wire:
 - 25 AWG
- Solder pots:
 - 26 AWG or smaller
- PC tails:
 - 24 AWG

Material and Finishes

- Shell material
 - Aluminum alloy
- Shell plating
 - Electroless nickel
 - Yellow chromate /cadmium over nickel
- Insulator
 - Liquid crystal polymer per MIL-M-24519, type GLCP-30F
- At temperatures above 175°C, yellow chromate over cadmium can cause shell discoloration and deterioration of the chromate conversion coating.

Hardware Configurations

| Commercial | | Per MIL-DTL-83513 | |
|------------|---|-------------------|---|
| Code | Description | Code | Description |
| A | No hardware (.125 dia. hole for sizes 9-51 & .166 dia. hole for size 100") | | Size 9-51 |
| B | No hardware (standard) (.091 dia. hole for size 9-51 & .120 dia. hole for size 100) | M2 | Jackscrew-low profile (allen head) |
| B1 | No hardware (.1475 dia. hole for size 100) | M3 | Jackscrew-standard profile (allen head) |
| F | Float mount | M5 | Jackscrew-low profile (slotted head) |
| K | Jackscrew-standard profile | M6 | Jackscrew-standard profile (slotted head) |
| L | Jackscrew-low profile | M7 | Jackpost |
| P | Jackpost | | Size 100 |
| S | Clinch Nut | M12 | Jackscrew-low profile (allen head) |
| | PCB Only | M13 | MDM-BT-25TE-SJS |
| R1 | Rear Panel Mount Jackpost, .032" Panel | M15 | |
| R2 | Rear Panel Mount Jackpost, .047" Panel | M16 | |
| R3 | Rear Panel Mount Jackpost, .062" Panel | M17 | Jackpost |
| R4 | Rear Panel Mount Jackpost, .093" Panel | | |
| R5 | Rear Panel Mount Jackpost, .125" Panel | | |

Termination Modification Codes

| Stranded Teflon® Wire per MIL-W-16878/4 (H) | | | Solid Uninsulated Wire (L) | |
|---|------------|-------------|----------------------------|---------------|
| Length | All Yellow | Color Coded | Termination Code | Length |
| 3 (76.2) | H020 | H027 | L61 | .125 (3.18) |
| 6 (152.4) | H019 | H016 | L56 | .150 (3.81) |
| 8 (203.2) | H026 | H034 | L57 | .190 (4.83) |
| 10 (254.0) | H029 | H025 | L39 | .250 (6.35) |
| 12 (304.8) | H028 | H002 | L58 | .375 (9.52) |
| 18 (457.2) | H001 | H003 | L1 | .500 (12.70) |
| 20 (508.0) | H038 | H023 | L14 | .750 (19.05) |
| 24 (609.6) | H009 | H004 | L2 | 1.000 (25.40) |
| 30 (762.0) | H010 | H005 | L7 | 1.500 (38.10) |
| 36 (914.4) | H011 | H006 | L6 | 2.000 (50.80) |
| 48 (1219.2) | H013 | H048 | L16 | 2.500 (63.50) |
| 72 (1828.8) | H017 | H046 | L10 | 3.000 (76.20) |
| 120 (3048.0) | H042 | H041 | | |

The above termination MODs are the most frequently ordered. For additional codes please see pp. 74-76

Dimensions shown in mm
Specifications and dimensions subject to change



200°C High Temp Micro MDM F222

MDM-F222

How to Order | Wired & Solder Pot

Wired & Solder Pot

R - MDM - 25 - P - H - 003 - M2 - A174 - F222

| | |
|----------------------------------|---|
| RoHS Compliance | |
| Series | MDM - Micro-D Metal Shell |
| Contact Arrangement | 9, 15, 21, 25, 31, 37, 51 & 100 |
| Contact Type | P - Pin / S - Socket |
| Termination Type | H - Insulated Stranded Wire, L - Uninsulated Stranded Wire, S - Solderpot |
| Termination Modified Code | See Termination Modification table for Harness Types (H) & Solid Uninsulated Types (L) |
| Hardware | Commercial A, B, B1, F, K, L, P, S Military M2, M3, M5, M6, M7, M12, M13, M15, M16, M17 |
| Shell Finish / MOD Codes* | *Blank - Yellow Chromate/Cadmium (Not RoHS Compliant), A174 - Electroless Nickel (RoHS Compliant) |
| High Temperature | F222 |

PCB

R - MDM - 25 - P - BR - P - T - L39 - A174 - F222

| | |
|----------------------------------|---|
| RoHS Compliance | |
| Series | MDM - Micro-D Metal Shell |
| Contact Arrangement | 9, 15, 21, 25, 31, 37, 51 & 100 |
| Contact Type | P - Pin / S - Socket |
| Termination Type | BS - Straight, BR - Right Angle, CBR - Condensed Right Angle |
| Hardware | Commercial A, B, B1, P, R1, R2, R3, R4, R5 Military M7, M17 |
| Mounting Hardware for PCB | T - Threaded Insert, No Letter - Thru-Hole |
| Length MOD Code | See Termination Modification table for Solid Uninsulated Types (L) |
| Shell Finish / MOD Codes* | *Blank - Yellow Chromate/Cadmium (Not RoHS Compliant), A174 - Electroless Nickel (RoHS Compliant) |
| High Temperature | F222 |

230°C Ultra-High Temp Micro MDM F300

MDM-F300

How to Order | Part Number Configurator



The Ultra-High Temp Micro-MDM series is qualification tested to withstand 230°C continuous operating temperature for 500 hours and meets the harsh requirements of the Oil and Gas exploration industries. Cannon's Ultra-High Temp Micro-MDM F300 connector is designated by an F300 modification code and uses high performance Micro Twist Pin Contacts, special insulating materials and high temperature wire.

MDM - **25** **P** **R** **003** **L** - **F300**

Series
MDM - MD Metal Shell

Contact Arrangement
9, 15, 21, 25, 31 & 37

Contact Type
P - Pin / S - Socket

Termination Type
R - Insulated Standards Wire / S - Solder Pot

Termination Modifier Code
(Consult Factory for all 'R', 'T' and 'U' Mod Codes for Lead Material and Length)

Hardware

| | | |
|---|--|--|
| P - Jackpost | K - Jackscrew-Standard Profile | Hardware per MIL-DTL-83513/5: Size 9-25: M2 - Jackscrew-low profile (Allen Head) M3 - Jackscrew-standard profile (Allen Head) M5 - Jackscrew-low profile (Slotted Head) M6 - Jackscrew-standard profile (Slotted Head) M7 - Jackpost |
| R1 - Rear Panel Mount Jackpost .032" Panel | L - Jackscrew-Low Profile | |
| R2 - Rear Panel Mount Jackpost .047" Panel | F - Float Mount | |
| R3 - Rear Panel Mount Jackpost .062" Panel | B - No hardware (Standard) .091 dia. hole for sizes 9-51 .120 dia. hole for size 100 | |
| R4 - Rear Panel Mount Jackpost .093" Panel | A - No hardware .125 dia. hole for sizes 9-51 .166 dia. hole for size 100 | |
| R5 - Rear Panel Mount Jackpost .125" Panel | B1 - No hardware .1475 dia. hole for size 100 (Per MIL-DTL-83513) | |
| K - Jackscrew-Standard Profile | S - Clinch Nut | |
| L - Jackscrew-Low Profile | | |

Shell Finish / MOD Codes
F300 - Stainless Steel Passivated Only

| High-Temp Wires Callouts | | | | |
|----------------------------|--------|-------|-----------------|----------|
| M22759/87-26-9 | | | | |
| Length | Yellow | White | 10-Color Repeat | System 1 |
| 1 | 030 | R30 | T30 | U30 |
| 2 | 024 | R24 | T24 | U24 |
| 3 | 020 | R20 | T20 | U20 |
| 4 | - | R33 | T33 | U33 |
| 5 | 031 | R31 | T31 | U31 |
| 6 | 019 | R65 | T19 | 072 |
| 8 | 026 | R26 | T26 | U26 |
| 9 | 015 | R15 | T15 | U15 |
| 10 | 029 | R29 | T29 | U29 |
| 12 | 028 | R66 | T28 | 073 |
| 16 | 029 | R39 | T39 | U39 |
| 17 | 036 | R36 | T36 | U36 |
| 18 | 001 | R67 | T01 | 074 |
| 20 | 038 | R38 | T38 | U38 |
| 21 | 055 | R55 | T55 | U55 |
| 24 | 009 | R68 | T09 | 075 |
| 30 | 010 | R10 | T10 | U10 |
| 35 | 018 | R18 | T18 | U18 |
| 36 | 011 | R69 | T11 | 076 |
| 40 | 037 | R37 | T37 | U37 |
| 42 | 012 | R12 | T12 | U12 |
| 48 | 013 | R70 | T13 | 077 |
| 50 | 040 | R40 | T40 | U40 |
| 60 | 014 | R14 | T14 | U14 |
| 72 | 017 | R71 | T17 | 078 |
| 80 | 032 | R32 | T32 | U32 |
| 92 | 022 | R22 | T22 | U22 |
| 96 | 035 | R35 | T35 | U35 |
| 120 | 042 | R42 | T42 | U42 |
| 180 | 043 | R43 | T43 | U43 |



Accessories

Shielded metal backshell

A single piece, machined aluminum shell for ITT Cannon MDM connectors. Cable braid can be fixed to the shell with the band-it strap (supplied with the backshell) to give a shielded termination. Stainless steel mounting hardware, either jackposts or low profile jack screws, comes with the backshell.

MATERIALS AND FINISHES

| | |
|--------------------|--|
| Backshell Material | Aluminum |
| Backshell Finish | Electroless Nickel or Yellow Chromate over Cadmium |
| Hardware Material | Stainless Steel |

Micro Metal Backshell for MDM Connectors

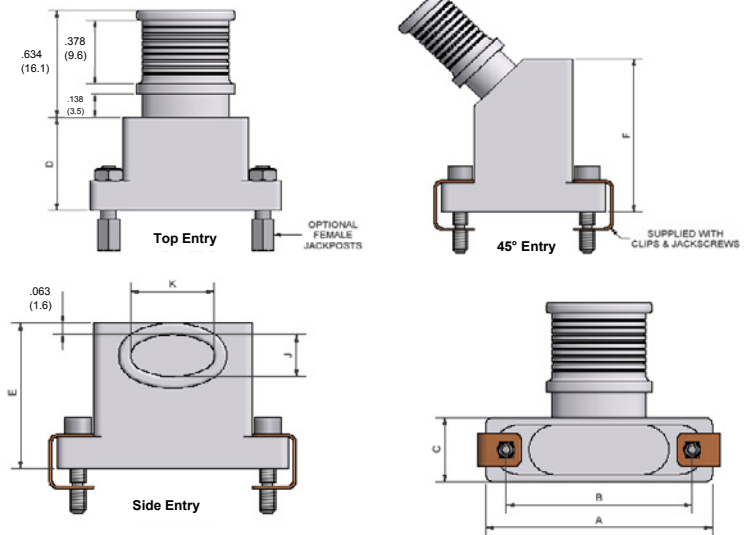

| Shell Size | A | B | C | D | E | F | Styles TE & SE | | Style AE | |
|------------|--------------|--------------|--------------|--------------|--------------|--------------|----------------|--------------|-------------|--------------|
| | | | | | | | J | K | J | K |
| 9 | 0.776 (19.7) | 0.565 (14.4) | 0.354 (9.0) | 0.394 (10.0) | 0.591 (15.0) | 0.827 (21.0) | 0.228 (5.8) | 0.276 (7.0) | 0.189 (4.8) | 0.189 (4.8) |
| 15 | 0.921 (23.4) | 0.715 (18.2) | 0.354 (9.0) | 0.472 (12.0) | 0.650 (16.5) | 0.906 (23.0) | 0.228 (5.8) | 0.425 (10.8) | 0.189 (4.8) | 0.189 (4.8) |
| 21 | 1.075 (27.3) | 0.865 (22.0) | 0.354 (9.0) | 0.551 (14.0) | 0.709 (18.0) | 0.984 (25.0) | 0.228 (5.8) | 0.425 (10.8) | 0.228 (5.8) | 0.276 (7.0) |
| 25 | 1.175 (29.9) | 0.965 (24.5) | 0.354 (9.0) | 0.630 (16.0) | 0.787 (20.0) | 1.063 (27.0) | 0.228 (5.8) | 0.598 (15.2) | 0.228 (5.8) | 0.425 (10.8) |
| 31 | 1.327 (33.7) | 1.115 (28.3) | 0.354 (9.0) | 0.669 (17.0) | 0.827 (21.0) | 1.102 (28.0) | 0.228 (5.8) | 0.598 (15.2) | 0.228 (5.8) | 0.425 (10.8) |
| 37 | 1.476 (37.5) | 1.265 (32.1) | 0.354 (9.0) | 0.709 (18.0) | 0.866 (22.0) | 1.142 (29.0) | 0.228 (5.8) | 0.791 (20.1) | 0.228 (5.8) | 0.598 (15.2) |
| 51 | 1.421 (36.1) | 1.215 (30.9) | 0.394 (10.0) | 0.748 (19.0) | 0.906 (23.0) | 1.181 (30.0) | 0.268 (6.8) | 0.898 (22.8) | 0.268 (6.8) | 0.697 (17.7) |
| 100 | 2.165 (55.0) | 1.800 (45.7) | 0.433 (11.0) | 0.827 (21.0) | 0.984 (25.0) | 1.496 (38.0) | 0.307 (7.8) | .024 (26.0) | 0.307 (7.8) | 1.024 (26.0) |

MDM-BT - 15 - TE - SJS - CAD - ***

Band Tied Backshell

Shell Size

Cable Entry

TE = Top entry

AE = Angles (45°) entry

SE = Side entry

Hardware

SJS = Spring clips and jackscrews

JP = jackposts

Planting

Blank - Electroless nickel

CAD - Yellow chromate over cadmium

Modification Code

Smaller cable entry - Consult factory

| Rev | Size | Part Number | Nomenclature | RoHS Code |
|-----|------|-------------|---------------------|-----------|
| - | 9 | 980-0011-38 | MDM-BT-9TE-SJS-CAD | NTC |
| - | 9 | 980-0011-39 | MDM-BT-9TE-SJS | ROH |
| - | 15 | 980-0011-40 | MDM-BT-15TE-SJS-CAD | NTC |
| - | 15 | 980-0011-36 | MDM-BT-15TE-SJS | ROH |
| - | 21 | 980-0011-41 | MDM-BT-21TE-SJS-CAD | NTC |
| - | 21 | 980-0011-42 | MDM-BT-21TE-SJS | ROH |
| - | 21 | 980-0011-53 | MDM-BT-21SE-SJS-CAD | NTC |
| - | 25 | 980-0011-48 | MDM-BT-25TE-SJS-CAD | NTC |
| - | 25 | 980-0011-37 | MDM-BT-25TE-SJS | ROH |
| - | 25 | 980-0011-54 | MDM-BT-25SE-SJS-CAD | NTC |

| Rev | Size | Part Number | Nomenclature | RoHS Code |
|-----|------|-------------|---------------------|-----------|
| - | 31 | 980-0011-55 | MDM-BT-31SE-SJS-CAD | NTC |
| - | 31 | 980-0011-44 | MDM-BT-31TE-SJS-CAD | NTC |
| - | 31 | 980-0011-45 | MDM-BT-31TE-SJS | ROH |
| - | 37 | 980-0011-35 | MDM-BT-37TE-SJS-CAD | NTC |
| - | 37 | 980-0011-46 | MDM-BT-37TE-SJS | ROH |
| - | 51 | 980-0011-47 | MDM-BT-51TE-SJS-CAD | NTC |
| - | 51 | 980-0011-43 | MDM-BT-51TE-SJS | ROH |
| - | 51 | 980-0011-50 | MDM-BT-51TE-SJS | ROH |
| - | 100 | 980-0011-51 | MDM-BT-100TE-SJS | ROH |

Dimensions shown in mm

Specifications and dimensions subject to change

www.ittcannon.com

Micro-D Metal Shell - .050" Contact Spacing | MIL-DTL-83513

How to Order | Part Number Nomenclature - Slash Sheets 1-5, 10-27



M83513/ 01 - H100 ** ****

Series

- MDM - Metal Shell, Liquid Crystal Polymer (LCP)
- MDB - Diallyl Phthalate Insulator
- MDVB - Polyester Insulator
-

MIL-DTL-83513 Slash Sheet

- 01 - Plug, Connector, Solderpot
 - 02 - Receptacle, Connector, Solderpot
 - 03 - Plug, Connector, Crimp Type
 - 04 - Receptacle, Connector, Crimp Typet
 - 05 - Hardware Only Δ
- } Metal Shell

Insert Arrangements

METAL SHELL

- A - 9 Contact
- B - 15 Contact
- C - 21 Contact
- D - 25 Contact
- E - 31 Contact
- F - 37 Contact
- G - 51 Contact
- H - 100 Contact

Wire Type

No Number - For Solderpot

- 01 - 18" long, #26 AWG per MIL-W-22759/11-26-9 (all white)
- 02 - 36" long, #26 AWG per MIL-W-22759/11-26-9 (all white)
- 03 - 18" long, #26 AWG per MIL-W-22759/11-26 Color Coded per MIL-STD-681, System 1, 10 colors repeating Δ
- 04 - 36" long, #26 AWG per MIL-W-22759/11-26-Color Coded per MIL-STD-681, System 1, 10 colors repeating Δ
- 05 - .5" long, #25 AWG, type S per QQ-W-343, Gold Plated
- 06 - 1.0" long, #25 AWG, type S per QQ-W-343, Gold Plated
- 07 - .5" long, #25 AWG, type S per QQ-W-W-343, Tin Plated
- 08 - 1.0" long, #25 AWG, type S per QQ-W-343, Tin Plated
- 09 - 18" long, #26 AWG per MIL-W-22759/33-26-9 (all white) Δ
- 10 - 36" long, #26 AWG per MIL-W-22759/33-26-9 (all white) Δ
- 11 - 18" long, #26 AWG per MIL-W-22759/33-26 Color Coded per MIL-STD-681, System 1, 10 colors repeating $\Delta \Delta$
- 12 - 36" long, #26 AWG per MIL-W-22759/33-26 Color Coded per MIL-STD-681, System 1, 10 colors repeating $\Delta \Delta$
- 13 - 72" long, #26 AWG per MIL-W-22759/11-26-9 (all white)
- 14 - 72" long, #26 AWG per MIL-W-22759/11-26 $\Delta \Delta$
- 15 - 72" long, #26 AWG per MIL-W-22759/33-26-9 (all white)
- 16 - 72" long, #26 AWG per MIL-W-22759/33-26 Color Coded per MIL-STD-681, System 1, 10 colors repeating $\Delta \Delta$

Shell Finish

- C - for Cadmium/Yellow chromate over nickels
- N - A174 - Electroless Nickel A174

NOTE:

- 1 - For every Mil Spec Part Number, ITT has one corresponding part number shown an example
- 2 - Tolerance on wire lengths: 18", 36" and 72" long — +1.00"/-0.00"
.5" and 1.00" — +.200"/-.000"
- Δ - For space application, connector shell finish must be "A174" and wire must be per MIL-W-22759/33-26.
- 4 - Any deviations to these P/N's will result in assignment of a special P/N, consult factory.
- Δ - Color coding in accordance with MIL-STD-681, System 1, no parenthesis. See pages 80-81 for color code chart.
- Δ - For mounting hardware to Military Specification (sizes 9 to 100) see page 16.



Dimensions shown in mm
Specifications and dimensions subject to change

www.ittcannon.com

Micro-D Metal Shell - .050" Contact Spacing | MIL-DTL-83513

How to Order | Part Number Nomenclature - Slash Sheets 1-5, 10-27



M83513/ 10 - A ** C *

Series

Connector, Electrical, Rectangular
Microminiature, Polarized Shell
PC Board Mounting

MIL-DTL-83513 Slash Sheet

- 10 - Connector, Plug, Condensed Board Right Angle (CBR), Sizes 9 – 37
- 11 - Connector, Plug, CBR, Size 51
- 12 - Connector, Plug, CBR, Size 100
- 13 - Connector, Receptacle, CBR, Sizes 9 – 37
- 14 - Connector, Receptacle, CBR Size 51
- 15 - Connector, Receptacle, CBR, Size 100
- 16 - Connector, Plug, Board Right Angle (BR), Sizes 9 – 37
- 17 - Connector, Plug, BR, Size 51
- 18 - Connector, Plug, BR, Size 100
- 19 - Connector, Receptacle, BR, Sizes 9 – 37
- 20 - Connector, Receptacle, BR Size 51
- 21 - Connector, Receptacle, BR Size 100
- 22 - Connector, Plug, Board Straight (BS), Sizes 9 – 37
- 23 - Connector, Plug, BS, Size 51
- 24 - Connector, Plug, BS, Size 100
- 25 - Connector, Receptacle, BS, Sizes 9 – 37
- 26 - Connector, Receptacle, BS, Size 51
- 27 - Connector, Receptacle, BS Size 100

Insert Arrangements

METAL SHELL

- A - 9 Contact
- B - 15 Contact
- C - 21 Contact
- D - 25 Contact
- E - 31 Contact
- F - 37 Contact
- G - 51 Contact
- H - 100 Contact

Wire Type

- 01 - .109" long, #24 AWG solid copper wire per QQ-W-343, Type "S", solder dipped
- 02 - .140" long, #24 AWG solid copper wire per QQ-W-343, Type "S", solder dipped Δ
- 03 - .172" long, #24 AWG solid copper wire per QQ-W-343, Type "S", solder dipped

Shell Finish

- C - Cadmium / Yellow chromate over nickel
- N - Electroless Nickel $\Delta \Delta$

HARDWARE

- N - No jackpost
- P - Jackpost (permanently attached)
- T - Threaded insert
- W - Jackpost and Threaded insert

NOTE:

- 1 - For every Mil Spec Part Number, ITT has one corresponding part number
- Δ - Tolerance on wire lengths: 18", 36" and 72" long — +1.00"/-0.00" .5" and 1.00" — +.200"/-.000"
- $\Delta \Delta$ - For space application, connector shell finish must be "A174" and wire must be per MIL-W-22759/33-26.
- 4 - Any deviations to these P/N's will result in assignment of a special P/N, consult customer service.

Dimensions shown in mm
Specifications and dimensions subject to change

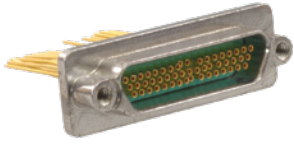

Our MDMH Hermetic Microminiature Connectors are ideal for applications that require more robust sealing than can be achieved with epoxy resins. The MDMH uses size 24 AWG contacts that are compression glass sealed through a steel shell and into a diallyl pthalate front-end insulator. When mated, an interfacial seal provides environmental protection. We recommend MDMH Hermetic receptacles be soldered to the chassis or container for a completely leak-proof joint. MDMH Hermetic receptacles mate with standard MDM plugs.

Specifications

Standard materials & finishes

| | |
|---------------------------------|--|
| Shell | Mild steel, tin-lead plated |
| Insulator | Glass filled diallyl pthalate per MIL-M-14. Type SDGF |
| Contacts | Copper alloy, gold plated sockets on mild steel gold plated pins. Solder pots - mild steel gold plated |
| Hermetic seal | Compression glass |
| Leak rate | 1 micron cubic ft/hr max (1.04 x 10 ⁻⁵ cc/sec at 1 ATM pressure differential) |
| ELECTRICAL DATA | |
| No. of contacts | 9 to 100 |
| Dielectric withstanding voltage | 150 VAC |
| Insulation resistance | 5000 Mohm minimum |
| Wire size | #26 through #30 AWG |
| Contact termination | Solder pot |
| MECHANICAL FEATURES | |
| Size or length | 8 sizes |
| Service class | Hermetically sealed |
| Coupling | Friction/jacks |
| Polarization | Keystone shaped shells |
| Contact spacing | .050 (1.27) centers |
| Shell style | Receptacle, solder mount |

How to Order

MDMH - 51 S S

Hermetic Micro D Receptacle Series

Contact layout 9, 15, 21, 25, 31, 37, 51, 100

Socket Contacts (only)

Termination type

Microminiature Connectors

MDMH Hermetic

Contact Arrangements

Face view of socket insert - use reverse order for wiring side.

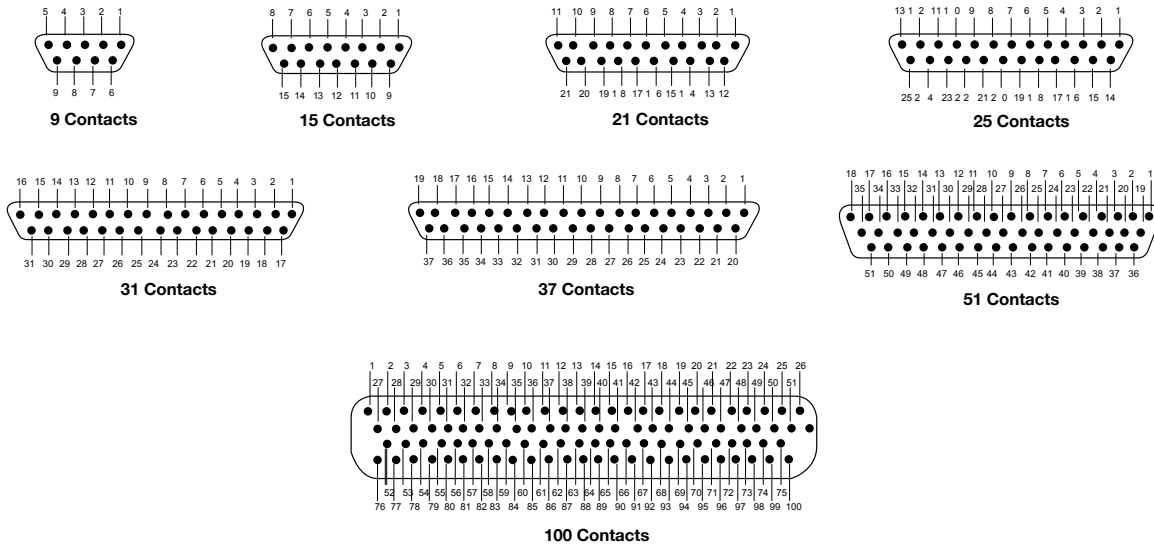

Contact identification numbers are for reference only and do not appear on insulator or connector body.

Shell Dimensions

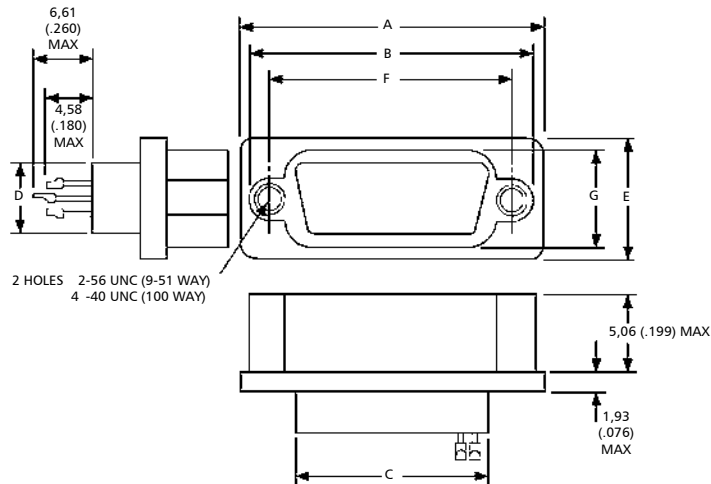

| Part Number By Shell Size | A Max. | B Max. | C Max. | D Max. | E Max. | F ±.005 (0,13) | G Max. |
|------------------------------|---------------|---------------|---------------|-------------|--------------|-------------------|--------------|
| MDMH-9S | .885 (22,48) | .738 (18,74) | .400 (10,16) | .270 (6,86) | .430 (10,92) | .565 (14,35) | .261 (6,63) |
| MDMH-15S | 1.035 (26,29) | .888 (22,55) | .550 (13,97) | .270 (6,86) | .430 (10,92) | .715 (18,16) | .261 (6,63) |
| MDMH-21S | 1.185 (30,10) | 1.038 (26,36) | .770 (17,78) | .270 (6,86) | .430 (10,92) | .865 (21,97) | .261 (6,63) |
| MDMH-25S | 1.285 (32,64) | 1.137 (28,87) | .800 (20,32) | .270 (6,86) | .430 (10,92) | .965 (24,51) | .261 (6,63) |
| MDMH-31S | 1.435 (36,45) | 1.288 (32,72) | .950 (24,13) | .270 (6,86) | .430 (10,92) | 1.115 (28,32) | .261 (6,63) |
| MDMH-37S | 1.585 (40,26) | 1.438 (36,53) | 1.100 (27,94) | .270 (6,86) | .430 (10,92) | 1.265 (32,13) | .261 (6,63) |
| MDMH-51S | 1.535 (38,99) | 1.388 (35,26) | 1.050 (26,67) | .310 (8,00) | .473 (12,01) | 1.215 (30,86) | .315 (8,00) |
| MDMH-100S | 2.275 (57,78) | 2.078 (52,78) | 1.455 (36,97) | .365 (9,27) | .522 (13,26) | 1.800 (45,72) | .410 (10,41) |

Dimensions shown in mm
Specifications and dimensions subject to change

www.ittcannon.com



Microminiature Connectors

TMDM Filter

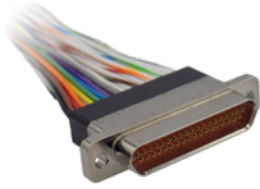

Our TMDM Filtered Microminiature Connectors feature transverse monolith filters for noise reduction and EMI, RFI and EMP shielding. These high performance connectors feature a ruggedized, one-piece aluminum shell and are ideally suited for commercial aerospace, military avionics and military equipment applications. The TMDM Filtered Micro is designed with Cannon's own Twist Pin Contact System and is environmentally sealed. The TMDM receptacle accommodates from 8 to 37 sizes, 24 AWG socket contacts on 1.27 (.050) centers and mates with standard MDM Microminiature Connector plugs.

Specifications

Standard materials & finishes

| | |
|---------------------------------|---|
| Shell | Aluminum alloy per QQ-A-200/8 with electroless nickel finish per QQ-N-290 |
| Insulator | Glass filled diallyl phthalate per MIL-M-14. Type SDGF |
| Contact, socket | Copper alloy, 50 microinch gold per MIL-G-45204, Type II, Class I |
| Interfacial seal | Silicone base rubber |
| ELECTRICAL DATA | |
| No. of contacts | 9 to 37 |
| Dielectric withstanding voltage | 300 VAC |
| Insulation resistance | 5000 Mohm at 100 VDC |
| Voltage rating (working) | 100 VDC |
| Current rating | 3 amps max. |
| Maximum capacitance | 250, 500, 1000, 2000 picofarads |
| Filter type | C |
| MECHANICAL FEATURES | |
| Size or length | 6 sizes |
| Coupling | Friction/jackscrews |
| Polarization | Keystone shaped shell |
| Contact spacing | .050 (1.27) centers |
| Shell style | Single piece receptacle |

How to Order

TMDM - C1 15 S H 001 B- *

Series

Filter type

Number of contacts

Contact style

Termination type

Termination/modifier code

Mounting code

Modification code

Series

Filter TMDM - Micro "D" - Metal housing

Contact Arrangements

"C" capacitor type

C1 150 - 250 pF capacitance

C2 300 - 500 pF capacitance

C3 700 - 1000 pF capacitance

C4 1300 - 2000 pF capacitance

Number of contacts

9, 15, 21, 25, 31, 37 only

* No number = Electroless Nickel A172 - Gold over Nickel

Contact style

S - socket (receptacle)

P - Pin (plug)

Termination code*

H - harness, insulated solid or stranded wire

L - lead, solid uninsulated wire

Termination

Consult standard wire termination code for lead material and lead length

Mounting code

A - Flange mounting, Ø.125 (3,18) mounting holes

B - Flange mounting, Ø.092 (2,34) mounting holes

L - Low profile (slotted head)

M2 - Allen head jackscrew assembly, low profile

M3 - Allen head jackscrew assembly, high profile

M5 - Slot head jackscrew assembly, low profile

M6 - Slot head jackscrew assembly, high profile

M7 - Jacknut assembly

P - Jackpost

Modification code

Shell finish MOD. Codes. *

To be assigned as required



Dimensions shown in mm
Specifications and dimensions subject to change

www.ittcannon.com

Microminiature Connectors

TMDM Filter

Guaranteed Minimum Attenuation

| Filter designation | Capacitance range (pF) | Minimum Insertion Loss-decibels | | | | | | | |
|--------------------|------------------------|---------------------------------|--------|--------|--------|---------|---------|---------|-------|
| | | 10 MHz | 15 MHz | 30 MHz | 50 MHz | 100 MHz | 200 MHz | 500 MHz | 1 GHz |
| C1 | 150 - 250 | | | | 4 | 6 | 15 | 20 | 35 |
| C2 | 300 - 500 | | | 3 | 6 | 12 | 18 | 25 | 40 |
| C3 | 700 - 1000 | | 3 | 7 | 13 | 17 | 25 | 38 | 48 |
| C4 | 1300 - 2000 | 5 | 8 | 13 | 18 | 23 | 30 | 40 | 50 |

Standard Wire Termination Codes

Cannon Modification Codes – (Not Mil Spec)

The following termination codes are listed for your information. For additional codes please refer to Appendix on pp. 74-76. All wire lengths are minimum.

Harness Type (H) #26 AWG per MIL-W-16878/4 Type E Teflon, stranded

| Length | All Yellow | Color Coded |
|--------|------------|-------------|
| 3 | H020 | H027 |
| 6 | H019 | H016 |
| 8 | H026 | H034 |
| 10 | H029 | H025 |
| 12 | H028 | H002 |
| 18 | H001 | H003 |
| 20 | H038 | H023 |
| 24 | H009 | H004 |
| 30 | H010 | H005 |
| 36 | H011 | H006 |
| 48 | H013 | H048 |
| 72 | H017 | H046 |
| 120 | H042 | H041 |

Solid Uninsulated Type (L) #25 AWG gold plated copper.

| Code | Length |
|------|---------------|
| L61 | .125 (.18) |
| L56 | .150 (3.81) |
| L57 | .190 (4.83) |
| L39 | .250 (5.35) |
| L58 | .375 (9.52) |
| L1 | .500 (12.70) |
| L14 | .750 (19.05) |
| L2 | 1.000 (25.40) |
| L7 | 1.500 (38.10) |
| L6 | 2.000 (50.80) |
| L6 | 2.500 (63.50) |
| L10 | 3.000 (76.20) |

Shell Dimensions

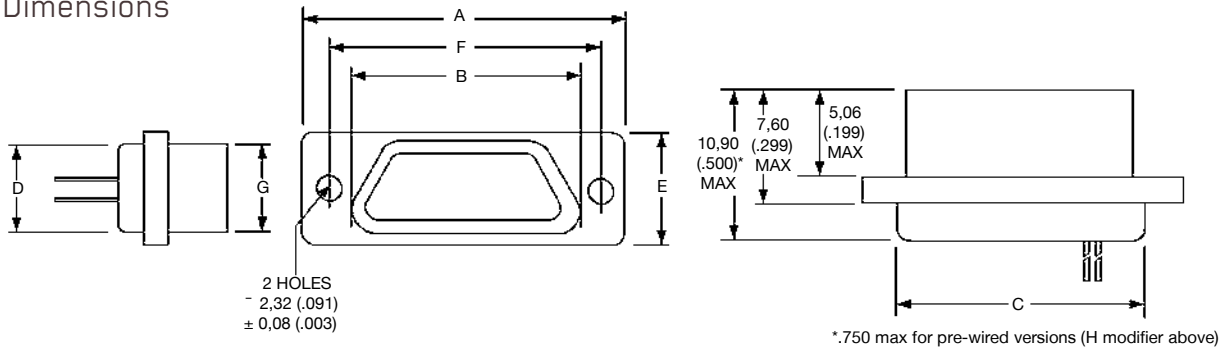

| Part Number By Shell Size | A Max. | B Max. | C Max. | D Max. | E Max. | F ±0,13 (.005) | G Max. |
|---------------------------|---------------|---------------|---------------|-------------|-------------|----------------|-------------|
| MDMT-95* | .785 (19,94) | .400 (10,16) | .400 (10,16) | .270 (6,86) | .308 (7,83) | .565 (14,36) | .251 (6,38) |
| MDMT-155* | .935 (23,75) | .550 (13,97) | .550 (13,97) | .270 (6,86) | .308 (7,83) | .715 (18,17) | .251 (6,38) |
| MDMT-215* | 1.085 (27,60) | .700 (17,78) | .770 (17,78) | .270 (6,86) | .308 (7,83) | .865 (21,98) | .251 (6,38) |
| MDMT-255* | 1.185 (30,10) | .800 (20,32) | .800 (20,32) | .270 (6,86) | .308 (7,83) | .965 (24,52) | .251 (6,38) |
| MDMT-315* | 1.335 (33,90) | .950 (24,13) | .950 (24,13) | .270 (6,86) | .308 (7,83) | 1.115 (28,30) | .251 (6,38) |
| MDMT-375* | 1.485 (37,70) | 1.100 (28,00) | 1.100 (28,00) | .270 (6,86) | .308 (7,83) | 1.265 (32,20) | .251 (6,38) |

Dimensions shown in mm
Specifications and dimensions subject to change

Microminiature Connectors

TMDM Filter

Typical Filter Performance

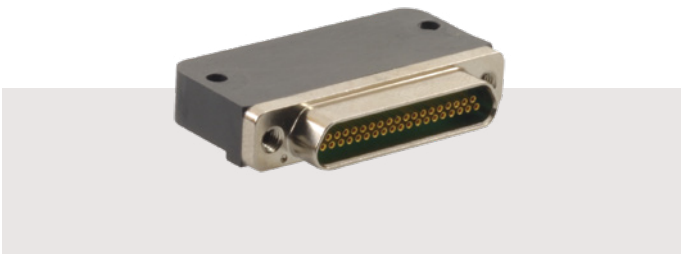
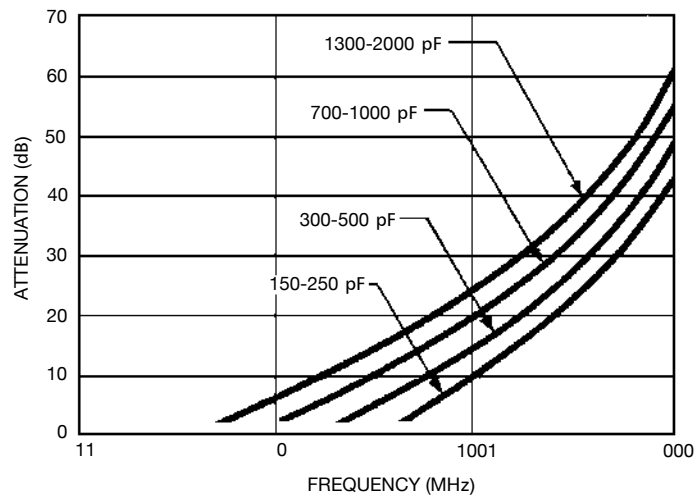

Micro-D Plastic Shell - .050" Contact Spacing

MD**



Cannon MD** Microminiature Solutions are used in applications requiring highly reliable, extremely small and lightweight interconnects. They are available in two insulator materials, two mounting variations, seven shell sizes accommodating from 9 to 51 contacts and a special arrangement of five micro contacts and two coaxials. The insulator materials give the Cannon MD** connector wide versatility in most applications. They can also terminate a wide variety of stranded or solid wire directly to Micro-D contacts, which is often desirable in high density arrangements. MD** Connectors can also be custom harnessed to meet any customer requirement.

Specifications

MATERIALS AND FINISHES

| | |
|-----------------------------|---|
| Shell/Insulator (One Piece) | MD/MDB: Glass-filled thermoset plastic MDV/MDVB: Thermoplastic |
|-----------------------------|---|

| | |
|----------|----------------------------|
| Contacts | - Copper alloy, gold plate |
|----------|----------------------------|

ELECTRICAL DATA

| | |
|----------------|--|
| No of Contacts | - 9 to 51: (1 arrangement of 5 contacts and 2 coaxials - for screw mount only) |
|----------------|--|

| | |
|---------------|--|
| Coaxial Cable | - RG-178/U (Not available for MD clip mount) |
|---------------|--|

| | |
|-----------|--------------------|
| Wire Size | - #24 thru #32 AWG |
|-----------|--------------------|

| | |
|---------------------|----------------------|
| Contact Termination | - Multi-indent crimp |
|---------------------|----------------------|

MECHANICAL FEATURES

| | |
|----------------|-----------|
| Size or Length | - 7 sizes |
|----------------|-----------|

| | |
|----------|-----------------------|
| Coupling | - Friction/jackscrews |
|----------|-----------------------|

| | |
|--------------|--------------------------|
| Polarization | - Keystone-shaped shells |
|--------------|--------------------------|

| | |
|-------------------------|-----------------|
| Contact Spacing Centers | - .050 (1.27mm) |
|-------------------------|-----------------|

| | |
|--------------|-----------------------|
| Shell Styles | - Plug and receptacle |
|--------------|-----------------------|

Consult factory for availability.

Micro-D Plastic Shell - .050" Contact Spacing

MD**

How to Order (PCB ordering information page 21)

| | | | | | | | | |
|---------------------------------|---|------|----|---|---|---|-----|---|
| | R | MD** | 1- | 9 | P | H | 001 | P |
| RoHS Compliance | | | | | | | | |
| Series-Insulator Style-Material | | | | | | | | |
| Contact Spacing | | | | | | | | |
| Contact Arrangement | | | | | | | | |
| Contact Type | | | | | | | | |
| Termination Type | | | | | | | | |
| Termination Code | | | | | | | | |
| Locking Hardware | | | | | | | | |

Series-Insulator Style-Material

MDB - Screw mounting-Diallyl phthalate
MDVB - Screw mounting-Polyester

Contact Spacing

1 - .050 (1.27) centers

Contact Arrangements

9-15-21-25-31-37-51. See page 12

Contact Type

P - Pin
S - Socket

Termination Type

H - Insulated solid or stranded wire
L - Uninsulated solid wire
S - Solder pot to accept #26 AWG max. harness wire

Termination Code

See page 79-80 for additional codes
(H) 001 - 18", 7/34 strand, #26 AWG, MIL-W-16878/4, Type E Teflon, Yellow.
(H) 003 - 18", 7/34 strand, #26 AWG, MIL-W-16878/4, Type E Teflon, color coded to MIL-STD-681 System I.
(L) 1 - 1/2" uninsulated solid #25 AWG gold plated copper.
(L) 2 - 1"uninsulated solid #25 AWG gold plated copper.

Locking Hardware (Screw Mounting Only)

P - Jackpost
K - Jackscrew-standard
L - Jackscrew-low profile
F - Float mount
M - Military specification hardware, see page 16.

No designator - No hardware - standard mounting
.091 (2.31) hole diameter



Dimensions shown in mm
Specifications and dimensions subject to change

www.ittcannon.com

Micro-D Plastic Shell - .050" Contact Spacing

MDB/MDVB

With Screw Mounting Holes (Conforms to MIL-DTL-83513)

MDB Glass-filled Diallyl Phthalate Plastic Insulator

MDVB Glass-filled Polyester Plastic Insulator

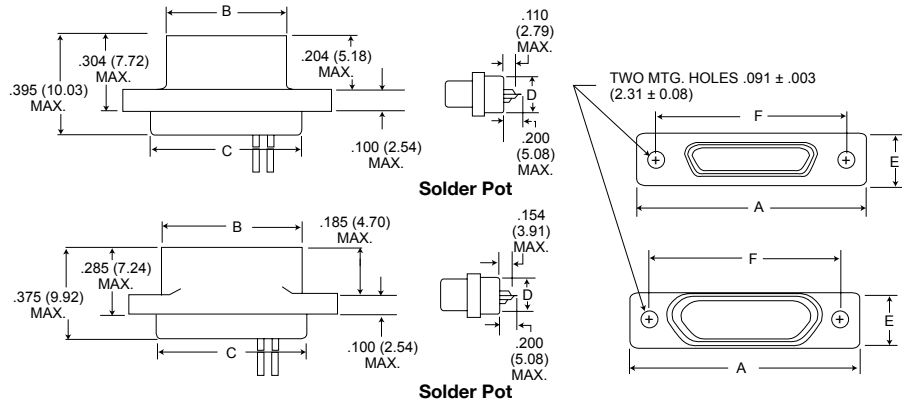

| Part Number by Shell Size | | A Max. | B Max. | C Max. | D Max. | E Max. | F ±0,13 (.005) | Avg. Weight*** ±5% (oz.) ±5% (gm.) |
|---------------------------|-------------|---------------|---------------|---------------|-------------|-------------|----------------|------------------------------------|
| MDB1-9P** | MDVB1-9P** | .788 (20.02) | .292 (7.42) | .408 (10.36) | .173 (4.39) | .218 (5.54) | .565 (14.36) | .026 (0.73) |
| MDB1-9S** | MDVB1-9S** | .788 (20.02) | .380 (9.65) | .408 (10.36) | .173 (4.39) | .218 (5.54) | .565 (14.36) | .025 (0.70) |
| MDB1-15P** | MDVB1-15P** | .938 (23.82) | .442 (11.23) | .588 (14.17) | .173 (4.39) | .218 (5.54) | .715 (18.16) | .038 (1.10) |
| MDB1-15S** | MDVB1-15S** | .938 (23.82) | .530 (13.46) | .588 (14.17) | .173 (4.39) | .218 (5.54) | .715 (18.16) | .035 (1.00) |
| MDB1-21P** | MDVB1-21P** | 1.088 (27.64) | .592 (15.04) | .708 (17.98) | .173 (4.39) | .218 (5.54) | .865 (21.97) | .053 (1.50) |
| MDB1-21S** | MDVB1-21S** | 1.088 (27.64) | .680 (17.27) | .708 (17.98) | .173 (4.39) | .218 (5.54) | .865 (21.97) | .050 (1.40) |
| MDB1-25P** | MDVB1-25P** | 1.188 (30.18) | .692 (17.58) | .808 (20.56) | .173 (4.39) | .218 (5.54) | .965 (24.51) | .063 (1.80) |
| MDB1-25S** | MDVB1-25S** | 1.188 (30.18) | .780 (19.81) | .808 (20.56) | .173 (4.39) | .218 (5.54) | .965 (24.51) | .056 (1.60) |
| MDB1-31P** | MDVB1-31P** | 1.338 (33.98) | .842 (21.39) | .958 (24.33) | .173 (4.39) | .218 (5.54) | 1.115 (28.32) | .080 (2.30) |
| MDB1-31S** | MDVB1-31S** | 1.338 (33.98) | .930 (23.62) | .958 (24.33) | .173 (4.39) | .218 (5.54) | 1.115 (28.32) | .073 (2.10) |
| MDB1-37P** | MDVB1-37P** | 1.488 (37.80) | .992 (25.20) | 1.108 (28.14) | .173 (4.39) | .218 (5.54) | 1.265 (32.13) | .086 (2.45) |
| MDB1-37S** | MDVB1-37S** | 1.488 (37.80) | 1.080 (27.43) | 1.108 (28.14) | .173 (4.39) | .218 (5.54) | 1.265 (32.13) | .076 (2.15) |
| MDB1-51P** | MDVB1-51P** | 1.438 (36.52) | .942 (23.93) | 1.058 (26.87) | .220 (5.59) | .260 (6.60) | 1.215 (30.86) | .109 (3.10) |
| MDB1-51S** | MDVB1-51S** | 1.438 (36.52) | 1.030 (26.16) | 1.058 (26.87) | .220 (5.59) | .260 (6.60) | 1.215 (30.86) | .093 (2.64) |

**Add lead type and length, see Part Number Explanation.

***Weight given is with 1/2", uninsulated solid #25 AWG gold plated copper pigtailed.

* For Standard Wire Termination codes refer to the wire pp. 74-76

Micro-D Plastic Shell - .050" Contact Spacing

MD*D-PCB

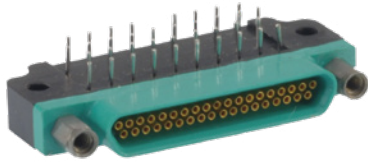

Cannon's MD*D-PCB Microminiature Connectors are designed with standard, all-plastic shells for use with flex circuitry, printed circuit and multi-layer boards. They are easily mounted and soldered, and offer high density and high reliability in board-to-board and board-to-cable applications. MD*D-PCB connectors are extremely small, lightweight and ruggedized for exceptional performance in the harshest environments. They are available in seven shell sizes, with 9 to 51 contacts in the popular 90° narrow profile PCB termination and a variety of tail lengths for varying board thickness. Jackpost mounting is also available for use with locking hardware.

How to Order

R **MD*B** - **37** **S** **CBR** ***** **L39** - *******

RoHS Compliance

Series

Contact Arrangement

Contact Type

Termination Type

Hardware

Termination Tail Length

Modification Codes (Consult Factory)

Connector Series

MDVB, MDB

Connector Arrangements

9-15-21-25-31-51

Contact Type

P - Pin

S - Socket

Termination Type

CBR - 90° Narrow Profile PCB Terminations

Hardware

P - Jackpost

M7 - Jackposts, M635135-07

No Letter = Less Hardware

Termination Tail Length Codes

None - .109 (2.77) ± 0.15 (0.38) Standard

L61 - .125 (3.18)

L66 - .150 (3.81)

L57 - .190 (4.83)

L39 - .250 (6.35)

L58 - .375 (9.52)



Dimensions shown in mm
Specifications and dimensions subject to change

www.ittcannon.com

Micro-D Plastic Shell - .050" Contact Spacing

MD*B-PCB

CBR Series (90° Mounting Narrow Profile)

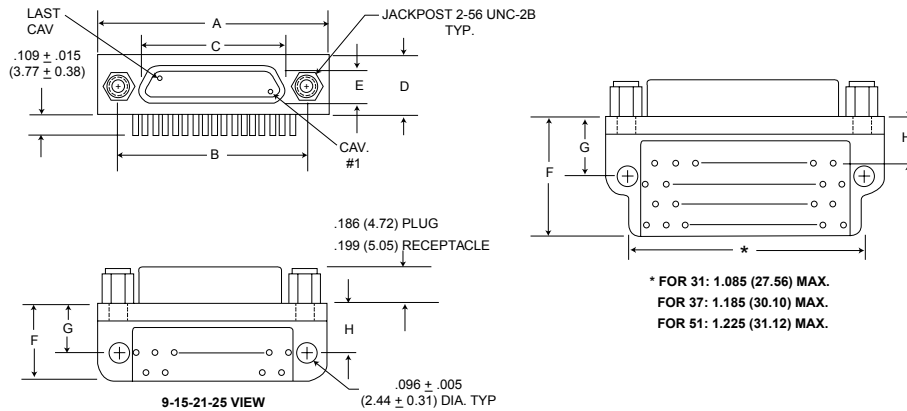

PCB Termination Arrangements (Viewed from bottom of connector, on PCB solder side.)

Identification number shown for plug connector, use reverse order for socket connector.

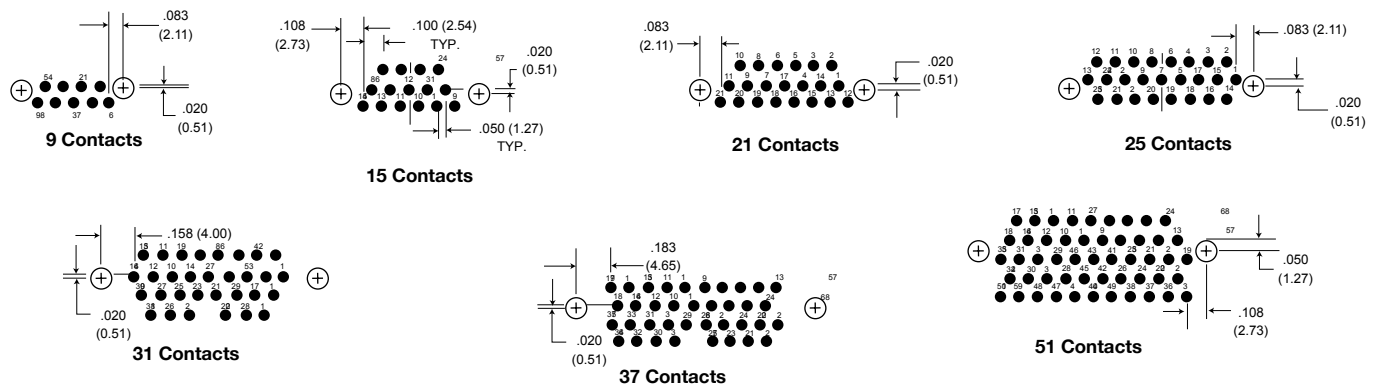

All Termination Configurations .100 (2.54) x .100 (2.54) Grid Pattern, Offset .050 (1.27)

| Part Number By Shell Size | A Max. | B $\pm .005$ (0.13) | C Max. | D Max. | E Max. | F Max. | G $\pm .010$ (0.25) | H $\pm .010$ (0.25) |
|------------------------------|---------------|------------------------|---------------|-------------|-------------|--------------|------------------------|------------------------|
| MD*B-9PCBR* | .788 (20.01) | .565 (14.35) | .292 (7.42) | .218 (5.54) | .134 (3.40) | .420 (10.67) | .250 (6.35) | .230 (5.84) |
| MD*B-9SCBR* | .788 (20.01) | .565 (14.35) | .375 (9.52) | .218 (5.54) | .218 (5.54) | .420 (10.67) | .250 (6.35) | .230 (5.84) |
| MD*B-15PCBR* | .938 (23.82) | .715 (18.16) | .442 (11.23) | .218 (5.54) | .134 (3.40) | .420 (10.67) | .250 (6.35) | .130 (3.30) |
| MD*B-15SCBR* | .938 (23.82) | .715 (18.16) | .525 (13.34) | .218 (5.54) | .218 (5.54) | .420 (10.67) | .250 (6.35) | .130 (3.30) |
| MD*B-21PCBR* | 1.088 (27.63) | .865 (21.97) | .592 (15.04) | .218 (5.54) | .134 (3.40) | .420 (10.67) | .250 (6.35) | .130 (3.30) |
| MD*B-21SCBR* | 1.088 (27.63) | .865 (21.97) | .675 (17.14) | .218 (5.54) | .218 (5.54) | .420 (10.67) | .250 (6.35) | .130 (3.30) |
| MD*B-25PCBR* | 1.188 (30.17) | .965 (24.51) | .692 (17.58) | .218 (5.54) | .134 (3.40) | .420 (10.67) | .250 (6.35) | .130 (3.30) |
| MD*B-25SCBR* | 1.188 (30.17) | .965 (24.51) | .775 (19.68) | .218 (5.54) | .218 (5.54) | .420 (10.67) | .250 (6.35) | .130 (3.30) |
| MD*B-31PCBR* | 1.338 (33.98) | 1.115 (28.32) | .842 (21.39) | .218 (5.54) | .134 (3.40) | .420 (10.67) | .250 (6.35) | .130 (3.30) |
| MD*B-31SCBR* | 1.338 (33.98) | 1.115 (28.32) | .925 (23.50) | .218 (5.54) | .218 (5.54) | .420 (10.67) | .250 (6.35) | .130 (3.30) |
| MD*B-37PCBR* | 1.488 (37.79) | 1.265 (32.13) | .994 (25.25) | .218 (5.54) | .134 (3.40) | .520 (13.21) | .250 (6.35) | .130 (3.30) |
| MD*B-37SCBR | 1.488 (37.79) | 1.265 (32.13) | 1.075 (27.30) | .218 (5.54) | .218 (5.54) | .520 (13.21) | .250 (6.35) | .130 (3.30) |
| MD*B-51PCBR* | 1.438 (36.52) | 1.215 (30.86) | .942 (23.93) | .258 (6.55) | .177 (4.50) | .550 (13.97) | .300 (7.62) | .150 (3.81) |
| MD*B-51SCBR | 1.438 (36.52) | 1.215 (30.86) | 1.026 (26.06) | .258 (6.55) | .258 (6.55) | .550 (13.97) | .300 (7.62) | .150 (3.81) |

* For jackpost locking add letter "P" or "M7".

NOTE: Standard lead termination is #24 AWG, solid copper, solder or tin dipped.

Dimensions shown in mm
 Specifications and dimensions subject to change

www.ittcannon.com



Micro-D Plastic Shell - .050" Contact Spacing MDB Coaxial

MDB Coaxial Series with Screw Mounting Holes

Cannon MDB Coaxial Microminiature Connectors feature two coaxial and five MicroPin /Micro-Socket contacts. Crimp-type coaxial contacts accommodate RG-178/U cables. A plastic insertion/extraction tool is supplied, with each connector assembly having a removable coaxial assembly.

How to Order - MDB Coaxial

R | **MDB** | **1** | **-7** | **C2** | ***** | **S** | **H** | ****** | ***** | **K**

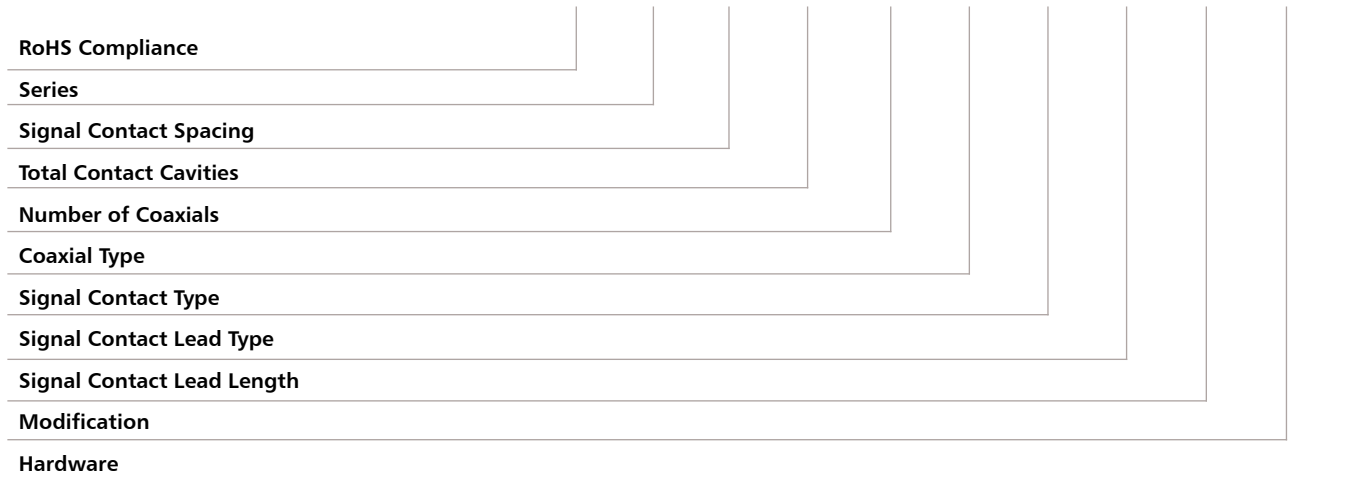

Series
Micro-D Coaxial

Signal Contact Spacing
1 - .050 (1.27) centers

Total Contact Cavities
7

Number of Coaxials
2

Coaxial Type
No Letter - Coaxial assembly installed and non removable
RO - Coaxial assembly ordered separately
RA - Coaxial shipped assembled but uninstalled

Signal Contact Type
P - Pin
S - Socket

Signal Contact Lead Type
L - Uninsulated, solid wire
H - Insulated, solid or stranded
S - Solder pot*

Signal Contact Lead Length
See Standard Wire Termination Code on page 29. Coaxial cable will be RG-178U unless otherwise specified; length will be same as wire modification.

Modification
Consult customer service

Hardware
No letter - No hardware standard mounting. .091 (2.31) hole diameter
F - Float
K - Jackscrew (standard)
L - Jackscrew (low profile)
P - Jackpost

* Not available with removable coax cable type connectors RO and RA.



How to Order - Coaxial Cable Assemblies



R | **MD** | **CC** | **S** | ***** | *******

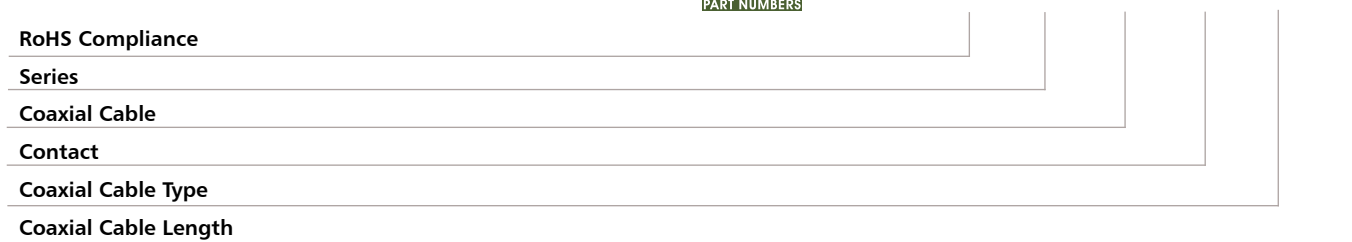

Series
MD

Coaxial Cable
CC

Signal Contact Type
P - Pin (used with socket side connection)
S - Socket (used with pin type connection)

Coaxial Cable Type
1 - RG178/U

Coaxial Cable Length
See Standard Wire Termination Codes on page 29. Coaxial cable will be RG-178U unless otherwise specified; length will be the same as wire modification.



Dimensions shown in mm
Specifications and dimensions subject to change

Micro-D Plastic Shell - .050" Contact Spacing

MDB

Dimension - MDB Coaxial Series

(See page 12 for layouts)

Plug

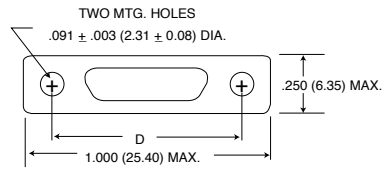
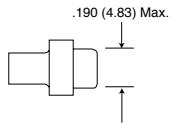

Receptacle

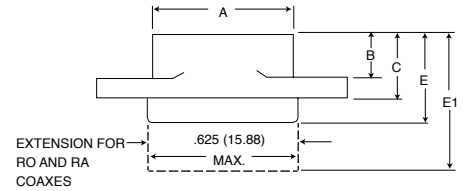
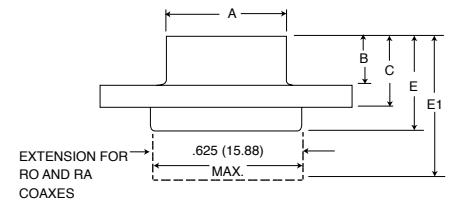
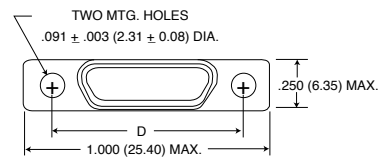
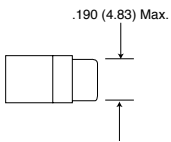

| Part Number By Shell Size | A Max. | B Max. | C Max. | D + .005 (0.13) | E Max. | E1 Max. | Avg. Weight** (oz) +_ 5% (gm.) +_ 5% |
|------------------------------|--------------|-------------|-------------|--------------------|--------------|--------------|---|
| MDB1-7C2P* | .510 (12.95) | .204 (5.18) | .298 (7.57) | .782 (19.86) | .395 (10.03) | .510 (12.95) | .290 (8.30) |
| MDB1-7C2S* | .602 (15.29) | .185 (4.70) | .279 (7.09) | .782 (19.86) | .375 (9.52) | .540 (13.72) | .273 (7.80) |

* Add lead type and length, see Part Number Explanation.

** Weight given is with 7 inch (177.80) insulated leads, #26 AWG silver plated copper pigtailed and RG178/U coaxials.

Micro-D Plastic Shell - .050" Contact Spacing

MD

Mounting Hardware Views (Sizes 9-51) - Front Panel Mounting

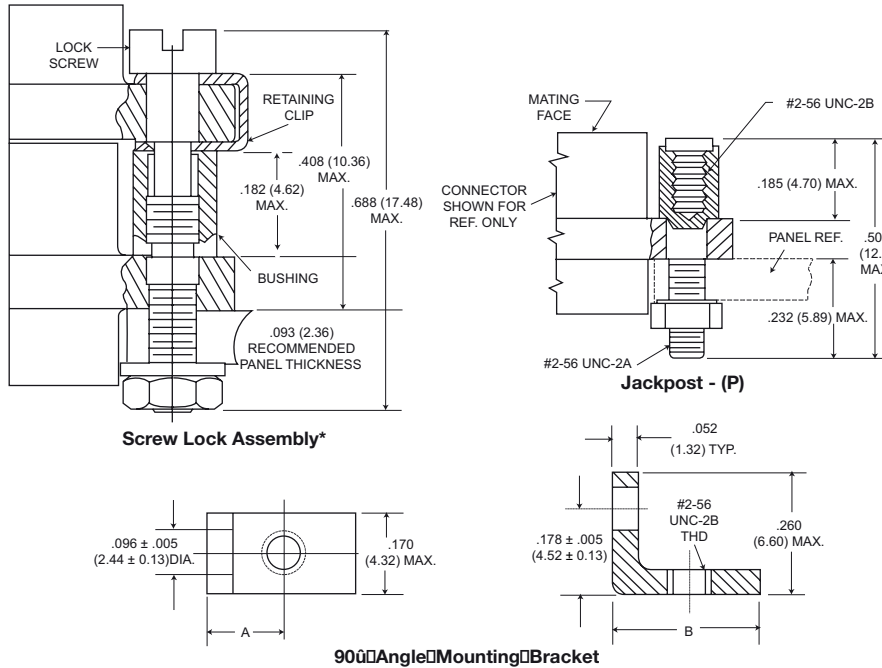

*NOTE: Torque value is 4.0 in/lbs max.

| Description | Part Number | A +/- .005 (0.13) | B Max. |
|---|------------------------------|----------------------|----------------|
| Screw Lock Assembly Jackpost Kit | 322-9500-000 320-9505-000 | | |
| Mounting Bracket, 90° Angle- MD*1 for 9 thru 37 Shell Sizes | 015-9516-000 | .100 (2.54) | .215 (5.46) |
| MD*1 for 51 Shell Size | 015-9516-000 | .122 (3.10) | .257 (6.53) |

NOTES: Screw lock assembly (322-9500-000) can be used for front mounting. Jackpost kit (320-9505-000) consists of 2 assemblies, shipped unassembled.

This hardware is factory installed.

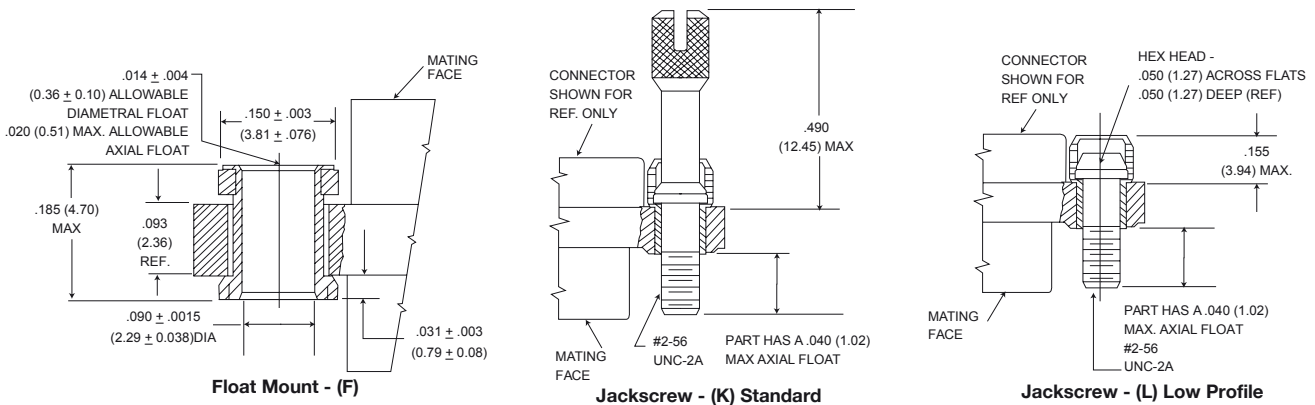

Shown here is a cutaway view of the float mount for the MD connector. The basic shell dimensions are the same for the float mount and the screw mounting hole configurations. View shown is for standard float mount front panel mounting. Reverse mounting is available on request.

* NOTE: Torque values are as follows:
Low Profile Jackscrew (L)-2.5 in/lbs
Standard Jackscrew (K)-2.5 in/lbs



Dimensions shown in mm
Specifications and dimensions subject to change

www.ittcannon.com

Micro-D Plastic Shell - .050" Contact Spacing

MD

Mounting Hardware to Military Specification (Sizes 9 - 51) PER MIL-DTL-83513/5

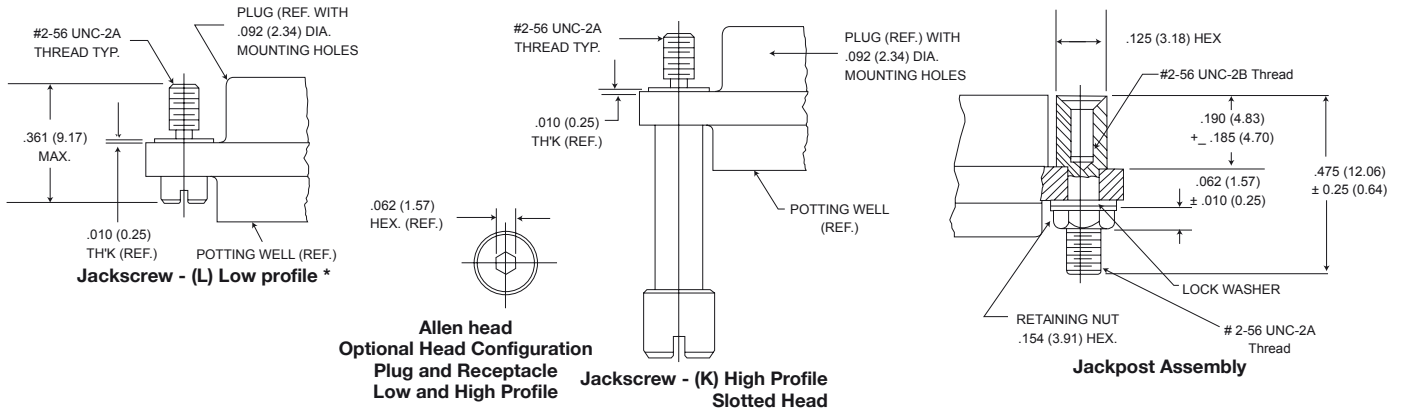

| Description | M83513/5 | Mode Code | Part Number |
|--|----------|-----------|--------------|
| Slotted Head Jackscrew Assy Low Profile | -05 | M5 | 320-9508-025 |
| Slotted Head Jackscrew Assy High Profile | -06 | M6 | 320-9508-027 |
| Allen Head Jackscrew Assy Low Profile | -02 | M2 | 320-9508-026 |
| Allen Head Jackscrew Assy High Profile | -03 | M3 | 320-9508-028 |
| Jackpost Assy | -07 | M7 | 320-9505-033 |

Jackpost Bushing (For Rear Panel Mounting)

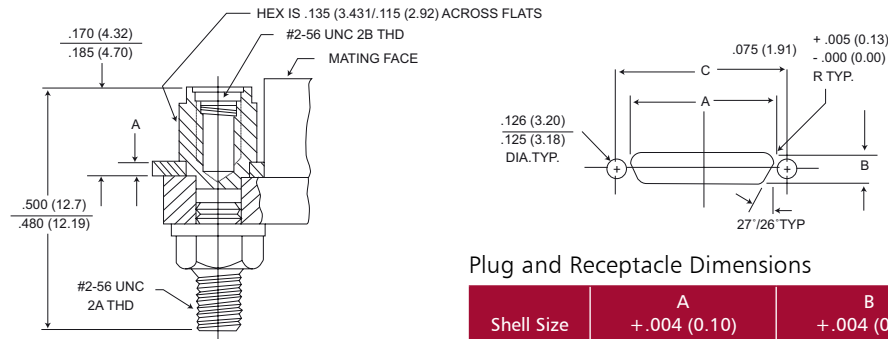

Plug and Receptacle Dimensions

| Shell Size | A +.004 (0.10) -.000 (0.00) | B +.004 (0.10) -.000 (0.00) | C +.005 (0.13) |
|------------|-----------------------------------|-----------------------------------|-------------------|
| 9 | .379 (9.63) | .219 (5.56) | .565 (14.35) |
| 15 | .529 (13.44) | .219 (5.56) | .715 (18.16) |
| 21 | .679 (17.25) | .219 (5.56) | .865 (21.97) |
| 25 | .779 (19.79) | .219 (5.56) | .965 (24.51) |
| 31 | .929 (23.60) | .219 (5.56) | 1.115 (28.32) |
| 37 | 1.079 (27.41) | .219 (5.56) | 1.265 (32.13) |
| 51 | 1.029 (26.14) | .261 (6.63) | 1.215 (30.86) |

*2 Jackposts, 2 nuts, 2 washers.
NOTE: Torque value for jackpost 2.5 in/lbs

Jackpost Bushing (For Rear Panel Mounting)

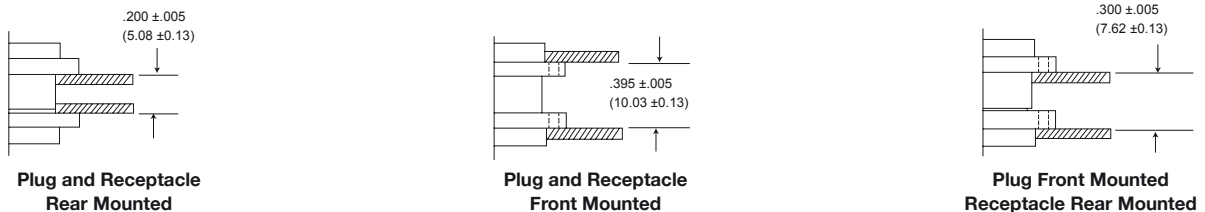

Dimensions shown in mm
Specifications and dimensions subject to change

Micro-D Plastic Shell - .050" Contact Spacing

MD

Panel Cutouts

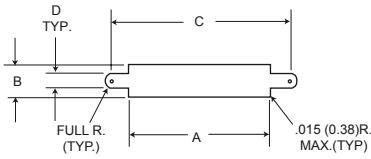

Figure 1
Front Mounting

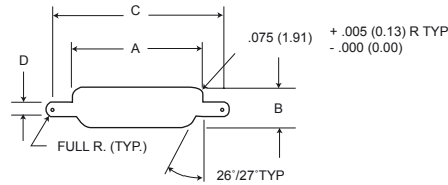

Figure 2
Rear Mounting

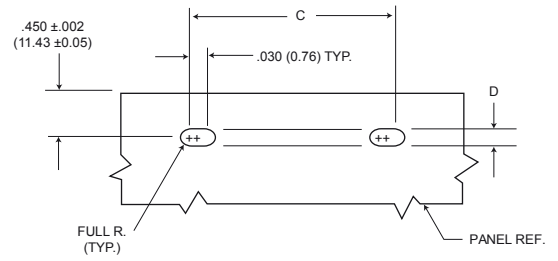

Figure 3
Edgeboard Mounting

| Size | Cutout Figure | A + .004 (0.10) - .000 (0.00) | B + .004 (0.10) - .000 (0.00) | C + .005 (0.13) - .000 (0.00) | D + .005 (0.13) - .000 (0.00) |
|------|---------------|-------------------------------------|-------------------------------------|-------------------------------------|-------------------------------------|
| 9 | 1 | .409 (10.39) | .172 (4.37) | .570 (14.48) | .089 (2.26) |
| | 2 | .379 (9.63) | .219 (5.56) | .570 (14.48) | .089 (2.26) |
| | 3 | - | - | .570 (14.48) | .089 (2.26) |
| 15 | 1 | .559 (14.20) | .172 (4.37) | .720 (18.29) | .089 (2.26) |
| | 2 | .529 (13.44) | .219 (5.56) | .720 (18.29) | .089 (2.26) |
| | 3 | - | - | .720 (18.29) | .089 (2.26) |
| 21 | 1 | .709 (18.00) | .172 (4.37) | .870 (22.10) | .089 (2.26) |
| | 2 | .679 (17.25) | .219 (5.56) | .870 (22.10) | .089 (2.26) |
| | 3 | - | - | .870 (22.10) | .089 (2.26) |
| 25 | 1 | .809 (20.55) | .172 (4.37) | .970 (24.64) | .089 (2.26) |
| | 2 | .779 (19.79) | .219 (5.56) | .970 (24.64) | .089 (2.26) |
| | 3 | - | - | .970 (24.64) | .089 (2.26) |
| 31 | 1 | .959 (24.36) | .172 (4.37) | 1.120 (28.45) | .089 (2.26) |
| | 2 | .929 (23.60) | .219 (5.56) | 1.120 (28.45) | .089 (2.26) |
| | 3 | - | - | 1.120 (28.45) | .089 (2.26) |
| 37 | 1 | 1.109 (28.17) | .172 (4.37) | 1.270 (32.26) | .089 (2.26) |
| | 2 | 1.079 (27.41) | .219 (5.56) | 1.270 (32.26) | .089 (2.26) |
| | 3 | - | - | 1.270 (32.26) | .089 (2.26) |
| 51 | 1 | 1.059 (26.90) | .215 (5.46) | 1.220 (30.99) | .089 (2.26) |
| | 2 | 1.029 (26.14) | .261 (6.63) | 1.220 (30.99) | .089 (2.26) |
| | 3 | - | - | 1.220 (30.99) | .089 (2.26) |

- NOTE:
1. Front mounting (figure 1) and rear mounting (figure 2) accommodates #2-56 screws.
 2. Front mounting is preferred. However, when rear mounting is necessary, use detail on previous page.
 3. Edgeboard mounting bracket (figure3) uses #2-56 screws. Dimension .450 ± .002 (11.43 ± 0.05) locates the MD receptacle flush with the end of the board.

Micro-D Plastic Shell - .050" Contact Spacing

MD/MDV

How to Order

R MD 1- 9 P H 001 P

| | |
|---------------------------------|--|
| RoHS Compliance | |
| Series-Insulator Style-Material | |
| Contact Spacing | |
| Contact Arrangement | |
| Contact Type | |
| Termination Type | |
| Termination Code | |
| Locking Hardware | |

Series-Insulator Style-Material
 MD - Clip mounting -Diallyl phthalate
 MDV - Clip mounting-Polyester

Contact Spacing
 1 - .050 (1.27) centers

Contact Arrangement
 9-15-21-25-31*-37-51. See page 12

Contact Type
 P - Pin
 S - Socket

Termination Type
 H - Insulated solid or stranded wire
 L - Uninsulated solid wire
 S - Solder pot to accept #26 AWG max. harness wire.

Termination Code**
 (H) 001 - 18", 7/34 strand, #26 AWG, MIL-W-16878/4, Type E Teflon, Yellow.
 (H) 003 - 18", 7/34 strand, #26 AWG, MIL-W-16878/4, Type E Teflon, color coded to MIL-STD-681 System I.
 (L) 1 - 1/2" uninsulated solid #25 AWG gold plated copper.
 (L) 2 - 1" uninsulated solid #25 AWG gold plated copper.

No designator - No hardware - standard mounting.091 (2.31) hole diameter
 *Not available in clip mounting. **See page 79-81 for additional codes



With Clip Mounting Slots

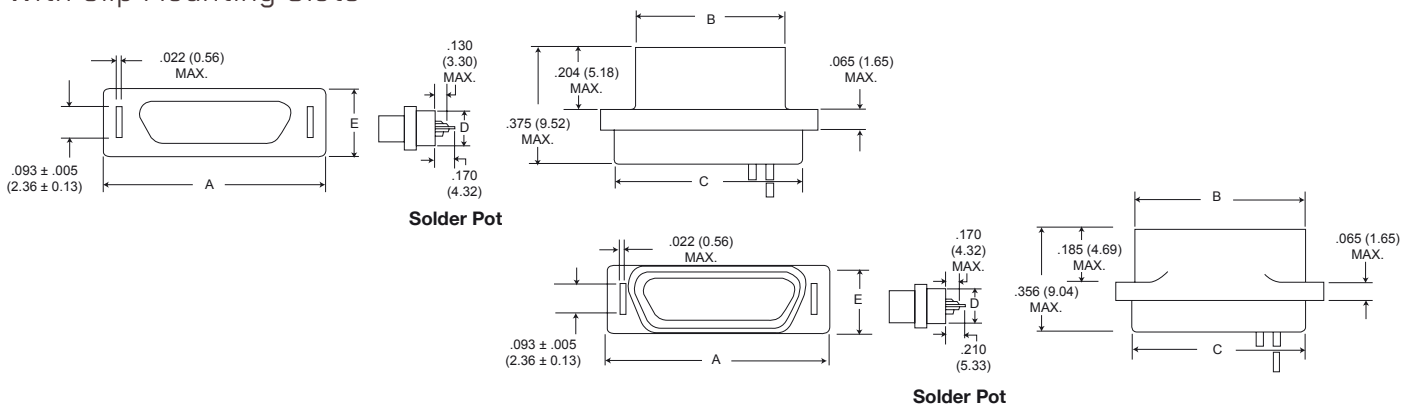

| Part Number By Shell Size | | A Max. | B Max. | C Max. | D Max. | E Max. | Avg. Weight*** ±5% (oz.)/±5% (gm.) |
|---------------------------|------------|---------------|---------------|---------------|-------------|-------------|------------------------------------|
| MD1-9P** | MDV1-9-P** | .512 (13.00) | .292 (7.42) | .405 (10.29) | .170 (4.32) | .215 (5.46) | .026 (0.73) |
| MD1-9S** | MDV1-9S** | .512 (13.00) | .376 (9.55) | .405 (10.29) | .170 (4.32) | .215 (5.46) | .026 (0.73) |
| MD1-15P** | MDV1-15P** | .662 (16.81) | .442 (11.23) | .555 (14.10) | .170 (4.32) | .215 (5.46) | .038 (1.10) |
| MD1-15S** | MDV1-15S** | .662 (16.81) | .526 (13.36) | .555 (14.10) | .170 (4.32) | .215 (5.46) | .038 (1.10) |
| MD1-21P** | MDV1-21P** | .812 (20.62) | .592 (15.04) | .705 (17.91) | .170 (4.32) | .215 (5.46) | .053 (1.50) |
| MD1-21S** | MDV1-21S** | .812 (20.62) | .676 (17.17) | .705 (17.91) | .170 (4.32) | .215 (5.46) | .050 (1.40) |
| MD1-25P** | MDV1-25P** | .912 (23.16) | .692 (17.58) | .805 (20.45) | .170 (4.32) | .215 (5.46) | .063 (1.80) |
| MD1-25S** | MDV1-25S** | .912 (23.16) | .776 (19.71) | .805 (20.45) | .170 (4.32) | .215 (5.46) | .056 (1.60) |
| MD1-37P** | MDV1-37P** | 1.212 (30.78) | .992 (25.20) | 1.105 (28.07) | .170 (4.32) | .215 (5.46) | .086 (2.45) |
| MD1-37S** | MDV1-37S** | 1.212 (30.78) | 1.076 (27.33) | 1.105 (28.07) | .170 (4.32) | .215 (5.46) | .076 (2.15) |
| MD1-51P** | MDV1-51P** | 1.162 (29.51) | .942 (23.93) | 1.055 (26.80) | .213 (5.41) | .258 (6.55) | .109 (3.10) |
| MD1-51S** | MDV1-51S** | 1.162 (29.51) | .026 (26.06) | 1.055 (26.80) | .213 (5.41) | .258 (6.55) | .093 (2.65) |

** Add lead type and length, see Part Number Explanation. *** Weight given is with 1/2", uninsulated solid #25 AWG gold plated copper pigtails.

Dimensions shown in mm
 Specifications and dimensions subject to change

www.ittcannon.com



Micro-D Plastic Shell - .050" Contact Spacing

MD**

Panel Mounting Hardware

| Description | Part Number |
|---|--------------|
| Panel Mounting Key | 201-9100-000 |
| Mounting Key and Coupling Clip Assembly | 294-9100-000 |
| Mounting Screw Bracket | 015-9100-000 |
| *Edgeboard Mounting Bracket | 015-5009-000 |
| **Edgeboard Mounting Bracket and Coupling Clip Assembly | MD51428-1 |

* Must be ordered separately; specify left and right hand for complete assembly.
 ** Must be ordered separately; assembly contains set of left and right hand types.

Dimensions (Clip Mounting Only)

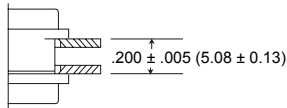

**Plug and Receptacle
Rear Mounted**

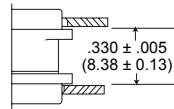

**Plug and Receptacle
Front Mounted**

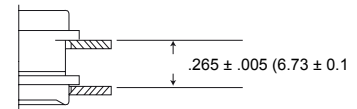

**Plug Front Mounted
Receptacle Rear Mounted**

Panel Cutouts

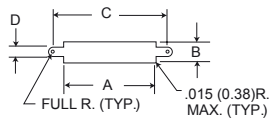

Figure 1

Front Mounting

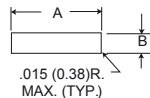
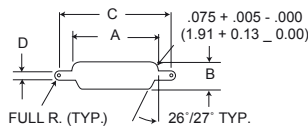
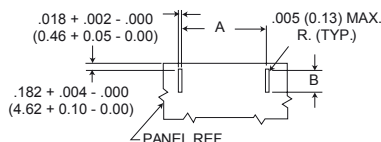

Figure 2



**Figure 3
Rear Mounting**



**Figure 4
Edgeboard Mounting**

| Shell Size | Cutout Figure | A + .004 (0.10) - .000 (0.00) | B + .004 (0.10) - .000 (0.00) | C + .004 (0.10) - .000 (0.00) | D + .005 (0.13) - .000 (0.00) |
|------------|---------------|-------------------------------------|-------------------------------------|-------------------------------------|-------------------------------------|
| 9 | 1 | .408 (10.36) | .172 (4.37) | .650 (16.51) | .089 (2.26) |
| | 2 | .408 (10.36) | .172 (4.37) | - | - |
| | 3 | .378 (9.60) | .217 (5.51) | .650 (16.51) | .089 (2.26) |
| | 4 | .400 (10.16) | .091 (2.31) | - | - |
| 15 | 1 | .588 (14.94) | .172 (4.37) | .795 (20.19) | .089 (2.26) |
| | 2 | .588 (14.94) | .172 (4.37) | - | - |
| | 3 | .528 (13.28) | .217 (5.51) | .795 (20.19) | .089 (2.26) |
| | 4 | .550 (13.97) | .091 (2.31) | - | - |
| 21 | 1 | .738 (18.75) | .172 (4.37) | .945 (24.00) | .089 (2.26) |
| | 2 | .738 (18.75) | .172 (4.37) | - | - |
| | 3 | .678 (17.27) | .217 (5.51) | .945 (24.00) | .089 (2.26) |
| | 4 | .700 (17.78) | .091 (2.31) | - | - |
| 25 | 1 | .838 (21.29) | .172 (4.37) | 1.045 (26.54) | .089 (2.26) |
| | 2 | .838 (21.29) | .172 (4.37) | - | - |
| | 3 | .778 (19.76) | .217 (5.51) | 1.045 (26.54) | .089 (2.26) |
| | 4 | .800 (20.32) | .091 (2.31) | - | - |
| 37 | 1 | 1.138 (28.91) | .172 (4.37) | 1.345 (34.16) | .089 (2.26) |
| | 2 | 1.138 (28.91) | .172 (4.37) | - | - |
| | 3 | 1.078 (27.38) | .217 (5.51) | 1.345 (34.16) | .089 (2.26) |
| | 4 | 1.078 (27.38) | .091 (2.31) | - | - |
| 51 | 1 | 1.088 (27.64) | .215 (5.46) | 1.295 (32.89) | .089 (2.26) |
| | 2 | 1.088 (27.64) | .215 (5.46) | - | - |
| | 3 | 1.028 (26.11) | .260 (6.60) | 1.295 (32.89) | .089 (2.26) |
| | 4 | 1.050 (26.67) | .091 (2.31) | - | - |

- NOTE:
1. A panel thickness of 1/8" (3.17mm) maximum is recommended for ease of tab bending when a panel mounting key & clip assembly or edgeboard mounting brackets are used.
 2. Front mounting is preferred. However, when rear mounting is necessary, use figure 3 for dimensions.
 3. Figure 4 is for edge board mounting bracket or edgeboard clip assembly. The .184 + .002 (2.67 + .05) dimension locates the MD socket insulator flush with the end of the board.
 4. Screw brackets (015-9100-000) will accommodate #2-56 screws.
 5. Front mounting (Figure 1) and rear mounting (Figure 3) accommodate #2-56 screws.



Dimensions shown in mm
 Specifications and dimensions subject to change

www.ittcannon.com

Micro Center Jackscrew

MJS



Cannon's MJS Micro Center Jackscrew Series provides a reliable interconnect for board-to-board, board-to-cable and inline cable-to-cable applications. Layouts accommodating up to 76 MicroPin/Micro-Socket contacts are available with a wide range of options.

How to Order

| | | | | | | | |
|---|-----|---|---|----|---|---|-----|
| R | MJS | * | - | 26 | P | H | 001 |
|---|-----|---|---|----|---|---|-----|

| | |
|----------------------------|--|
| RoHS Compliance | |
| Series | |
| Insulator Material | |
| Contact Arrangement | |
| Contact Type | |
| Termination Type | |
| Termination Codes | |

Series

MJS - Micro Center Jackscrew

Insulator Material

B - Diallyl phthalate

V - Polyester

U - Polyetherimide

R - Polyphenylene sulfide

Contact Arrangements

Unshrouded Receptacle: 10, 26, 51, 66

Shrouded Receptacle: 10, 26, 34, 38, 42, 76

Low Profile Plug and Receptacle (shrouded): 28

Contact Type

P - Pin

S - Socket

Termination Type

H - Insulated wire harness.

I - Integral tail (MJSV-28S only).

L - Solid - uninsulated wire.

S - Solder pot to accept #26 AWG harness wire.

T - Thru bundle pigtail (MJSV-28P only).

Termination Codes*

(H) 001 - 18" , 7/34 strand, #26 AWG, MIL-W-16878/4, Type E Teflon, yellow.

(H) 003 - 18" , 7/34 strand, #26 AWG, MIL-W-16878/4, Type E Teflon, color coded to MIL-STD-681 System I.

(L) 1 - 1/2" uninsulated solid #25 AWG gold plated copper.

(L) 2 - 1" uninsulated solid #25 AWG gold plated copper.

* See Termination Codes shown below.



Standard Wire Termination Codes

The following termination codes are listed for your information. For additional codes please refer to Appendix on pp. 74-76. All wire lengths are minimum.

Harness Type (H)

#26 AWG per MIL-W-16878/4 Type E Teflon, 7/34 stranded.

| Length | All Yellow | Color Coded |
|------------|------------|-------------|
| 3 (76.2) | H 020 | H 027 |
| 6 (152.4) | H 019 | H 016 |
| 8 (203.2) | H 026 | H 034 |
| 10 (254.0) | H 029 | H 025 |
| 12 (304.8) | H 028 | H 002 |
| 18 (457.2) | H 001 | H 003 |
| 20 (508.0) | H 038 | H 023 |

| Length | All Yellow | Color Coded |
|--------------|------------|-------------|
| 24 (609.6) | H 009 | H 004 |
| 30 (762.0) | H 010 | H 005 |
| 36 (914.4) | H 011 | H 006 |
| 48 (1219.2) | H 013 | H 048 |
| 72 (1828.8) | H 017 | H 046 |
| 120 (3048.0) | H 042 | H 041 |

Solid Uninsulated Type (L)

#25 AWG gold plated solid copper.

| Termination Code | Length | Termination Code | Length |
|------------------|--------------|------------------|---------------|
| L61 | .125 (3.18) | L14 | .750 (19.05) |
| L56 | .150 (3.81) | L2 | 1.000 (25.40) |
| L57 | .190 (4.83) | L7 | 1.500 (38.10) |
| L39 | .250 (6.35) | L6 | 2.000 (50.80) |
| L58 | .375 (9.53) | L16 | 2.500 (63.50) |
| L1 | .500 (12.70) | L10 | 3.000 (76.20) |

Contact Arrangements

Face view of pin-use reverse order for socket

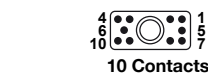

MJSB/MJSU (unshrouded)

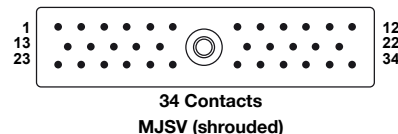
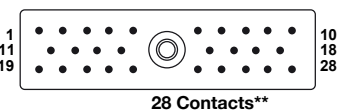
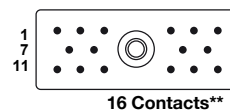

Identification numbers are for reference only and do not appear on connectors.

*Low profile configuration **MJSV & MJSR

Dimensions shown in mm

Specifications and dimensions subject to change

www.ittcannon.com

Micro Center Jackscrew

MJS

Unshrouded Receptacle (10-26-51-66)

MJSB/MJSU

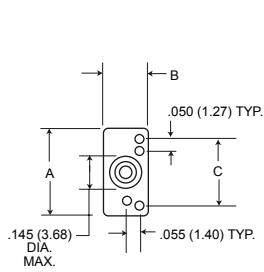

Rear View

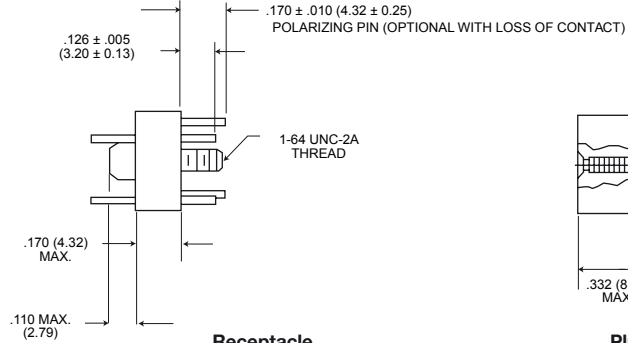

Receptacle

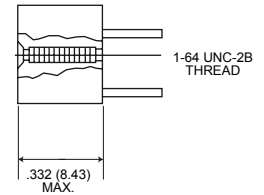

Plug

| Unshrouded Standard Materials and Finishes | |
|--|---|
| Micropin | Copper alloy, 50 micro-inch gold |
| Microsocket | Copper alloy, 50 micro-inch gold |
| Insulator | Diallyl phthalate, green color or polyetherimide, natural color |
| Jackscrew | Stainless steel, passivated & lubricated |
| Retainer, Jackscrew | Stainless steel, passivated |
| Insert, Threaded | Stainless steel, passivated |
| Post, Polarizing | Stainless steel, passivated |

| Part Number | A Max. | B Max. | C Bsc. |
|------------------|---------------|-------------|---------------|
| MJSB or MJSU-10P | .378 (9.60) | .190 (4.83) | .290 (7.37) |
| MJSB or MJSU-10S | .378 (9.60) | .190 (4.83) | .290 (7.37) |
| MJSB or MJSU-26P | .778 (19.76) | .190 (4.83) | .690 (17.53) |
| MJSB or MJSU-26S | .778 (19.76) | .190 (4.83) | .690 (17.53) |
| MJSB or MJSU-51P | 1.028 (26.11) | .260 (6.60) | .940 (23.88) |
| MJSB or MJSU-51S | 1.028 (26.11) | .260 (6.60) | .940 (23.88) |
| MJSB or MJSU-66P | 1.280 (32.51) | .260 (6.60) | 1.190 (30.23) |
| MJSB or MJSU-66S | 1.280 (32.51) | .260 (6.60) | 1.190 (30.23) |

Shrouded Receptacle (16-28*-34)

MJSB/MJSU

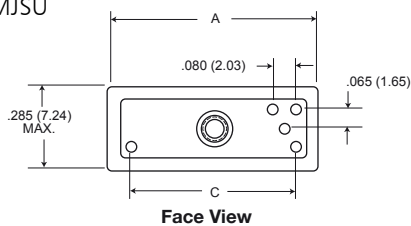

Face View

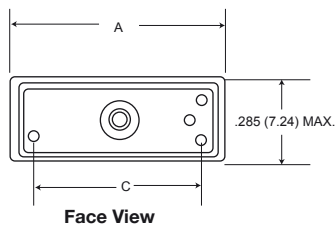

Face View

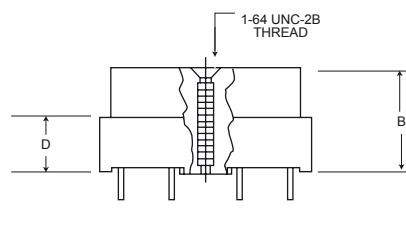

Plug

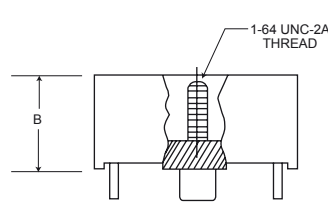
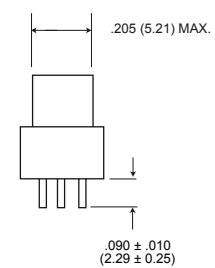

Receptacle

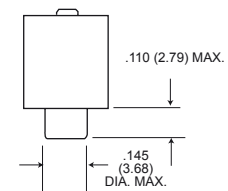

| Shrouded Standard Materials and Finishes | |
|--|--|
| Micropin | Copper alloy, 50 micro-inch gold |
| Microsocket | Copper alloy, 50 micro-inch gold |
| Insulator | Polyester, black color Polyphenylene sulfide, black color |
| Jackscrew | Stainless steel, passivated |
| Retainer, Jackscrew | Stainless steel, passivated |
| Insert, Threaded | Stainless steel, passivated |
| Post, Polarizing | Stainless steel, passivated |

| Part Number | A Max. | B Max. | C Ref. | D ± .006 (0.15) |
|------------------------|---------------|-------------|---------------|-----------------|
| MJSV or MJSR-16P | .700 (17.78) | .345 (8.76) | .545 (13.84) | .175 (4.45) |
| MJSV or MJSR-16S | .700 (17.78) | .320 (8.13) | .545 (13.84) | - |
| MJSV-28P* or MJSR-28P* | 1.020 (25.91) | .232 (5.89) | .865 (21.97) | .062 (1.57) |
| MJSV-28S* or MJSR-28S* | 1.020 (25.91) | .246 (6.25) | .865 (21.97) | - |
| MJSV-34P or MJSR-34P | 1.180 (29.97) | .330 (8.38) | 1.025 (26.04) | .160 (4.06) |
| MJSV-34S or MJSR-34S | 1.180 (29.97) | .305 (7.75) | 1.025 (26.04) | - |

*Low profile configuration, for "L" (uninsulated solid wire) termination add .090 (2.29) to the "B" dimension. For "H" (insulated wire) termination add .200 (5.08) to the "B" dimension. For special configurations with backpotted standoffs consult factory.



Dimensions shown in mm
Specifications and dimensions subject to change

www.ittcannon.com

Micro Center Jackscrew

MJS

Shrouded Plug

MJSR-42P

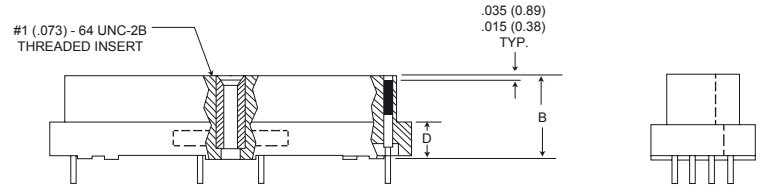
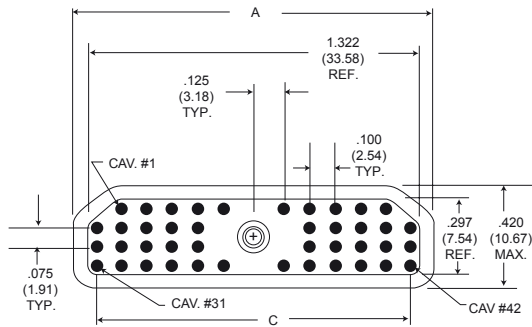

Shrouded Receptacle

MJSR-42S

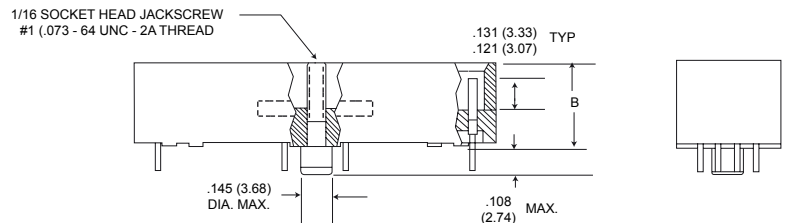
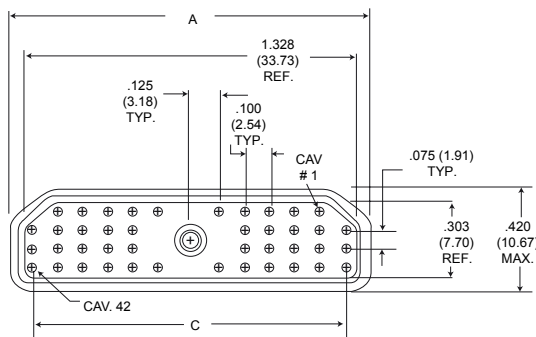

| Standard Materials and Finishes | |
|---------------------------------|------------------------------------|
| Micropin | Copper alloy, 50 micro-inch gold |
| Microsocket | Copper alloy, 50 micro-inch gold |
| Insulator | Polyphenylene sulfide, black color |
| Jackscrew | Stainless steel, passivated |
| Retainer, Jackscrew | Stainless steel, passivated |
| Insert, Threaded | Stainless steel, passivated |

| Part Number | A Max. | B Max. | C Ref. | D ± .006 (0.15) |
|-------------|---------------|-------------|---------------|--------------------|
| MJSR-42P | 1.445 (36.70) | .345 (8.76) | 1.250 (31.75) | .142 (3.61) |
| MJSR-42S | 1.445 (36.70) | .357 (9.07) | 1.250 (31.75) | - |

Dimensions shown in mm
Specifications and dimensions subject to change

www.ittcannon.com



Micro Center Jackscrew

MJS

Shrouded Receptacle (76)

MJSR-76P

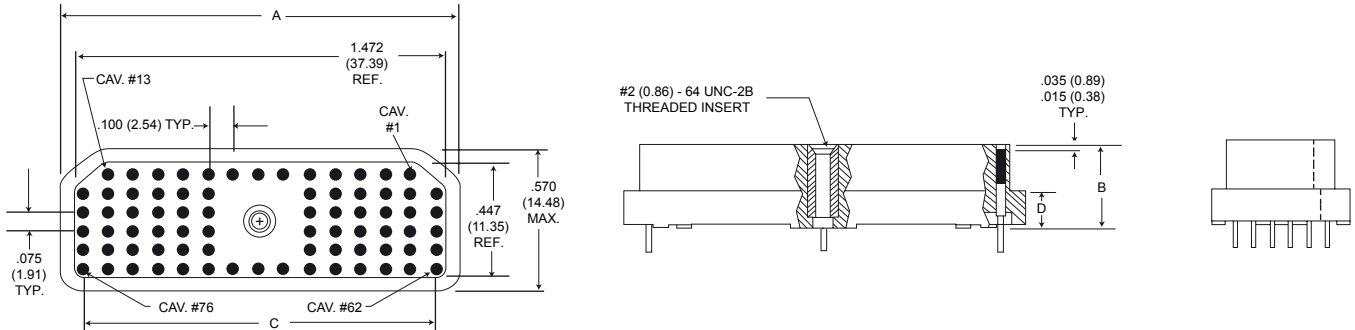

MJSR-76S

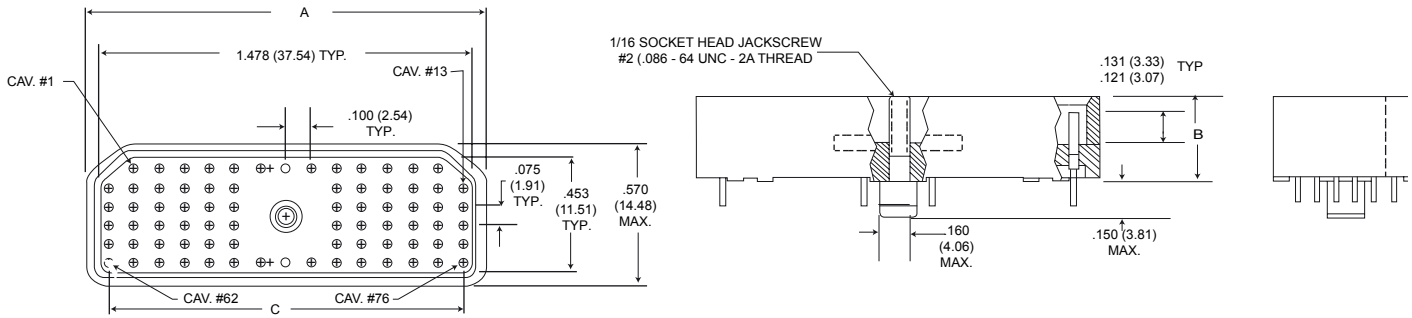

| Standard Materials and Finishes | |
|---------------------------------|------------------------------------|
| Micropin | Copper alloy, 50 micro-inch gold |
| Microsocket | Copper alloy, 50 micro-inch gold |
| Insulator | Polyphenylene sulfide, black color |
| Jackscrew | Stainless steel, passivated |
| Retainer, Jackscrew | Stainless steel, passivated |
| Insert, Threaded | Stainless steel, passivated |

| Part Number | A Max. | B Max. | C Ref. | D ± .006 (0.15) |
|-------------|---------------|-------------|---------------|--------------------|
| MJSR-76P | 1.595 (40.51) | .345 (8.76) | 1.400 (35.56) | .142 (3.61) |
| MJSR-76S | 1.595 (40.51) | .357 (9.07) | 1.400 (35.56) | - |



Dimensions shown in mm
Specifications and dimensions subject to change

www.ittcannon.com

Micro Center Jackscrew

MJS

Plug (Molded-In Insert - Special)

MJSV**P

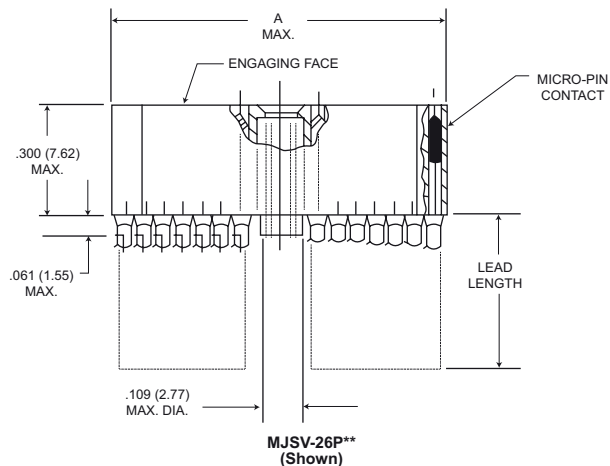
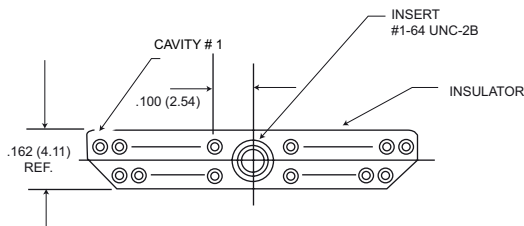

| Part Number | A Max. |
|-------------|---------------|
| MJSV-26P** | .868 (22.05) |
| MJSV-38P** | 1.168 (29.67) |

Receptacle (Special)

MJSV***S

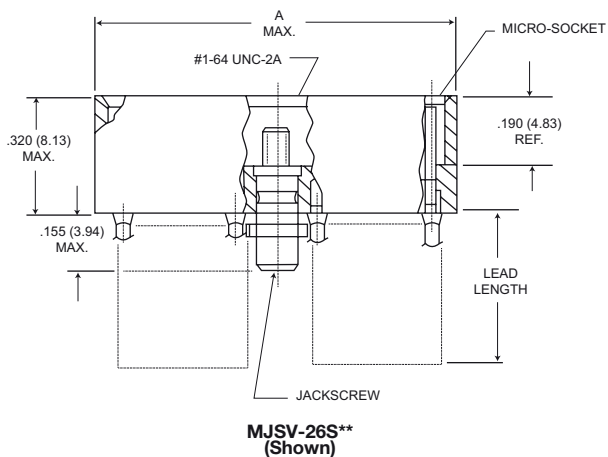
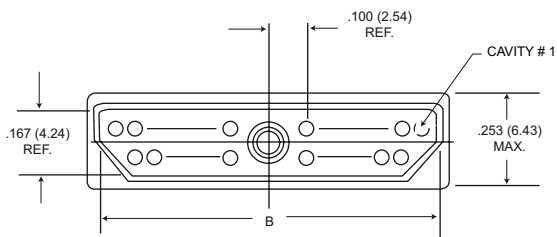

| Part Number | A Max. | B Max. |
|-------------|---------------|---------------|
| MJSV-26S** | .943 (23.95) | .874 (22.20) |
| MJSV-38S** | 1.243 (31.57) | 1.174 (29.82) |

Contact Arrangements

Face view of pin - use reverse order for socket

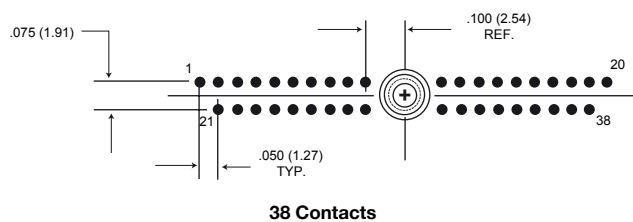
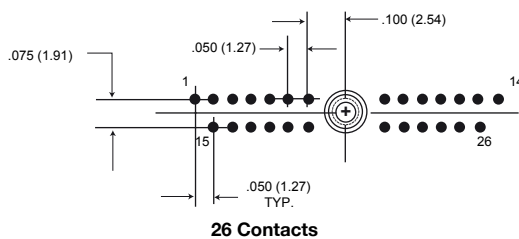

Identification numbers are for reference and do not appear on connectors.

Dimensions shown in mm
Specifications and dimensions subject to change

www.itcannon.com

cannon

Microminiature Circular - .050" Contact Spacing

MIK



Cannon's MIK Microminiature Circular Series Connectors are ruggedized, lightweight and meet the applicable requirements of MIL-DTL- 83513. Key markets and applications include biomedical, instrumentation and miniature black boxes. Our MIK Connector is designed to accommodate up to 55 contacts on .050 (1.27) centers (equivalent to 420 contacts per square inch). Five keyway polarization prevents cross plugging. Standard MIK Connectors are available in two shell sizes accommodating two contact arrangements pre-wired to your specific requirements. The threaded coupling nuts support connector strength and reliability. MIK receptacles can either be front or back panel mounted.

How to Order

| | | | | | | | | | |
|-------------------------|---|-----|---|----|----|---|---|----|-----|
| | R | MIK | M | 6- | 55 | P | * | ** | *** |
| RoHS Compliance | | | | | | | | | |
| Series | | | | | | | | | |
| Connector Type | | | | | | | | | |
| Shell Style | | | | | | | | | |
| Contact Arrangement | | | | | | | | | |
| Contact Type | | | | | | | | | |
| Termination Type | | | | | | | | | |
| Termination Length Code | | | | | | | | | |
| Hardware | | | | | | | | | |

Series

MIK: Microminiature Circular

Connector Type

No Letter - Screw coupling, plastic shell
 M - Screw coupling, metal shell
 Q - Push/Pull, metal shell

Shell Styles

0 - Wall mounting receptacle (MIK and MIKM only)
 6 - Straight plug (MIK, MIKM and MIKQ)
 7 - Jam nut mount (MIKQ only)
 9 - Rear panel mounted receptacle (MIKQ)

Contact Arrangements

7, 19, 37, 55, 85s

Contact Type

P - Pin
 S - Socket

Termination Types

H - Insulated round hook-up wire
 L - Uninsulated round solid wire

Termination Length Code (Standards)

(H) 001 - 18", 7/34 strand, #26 AWG, MIL-W-16878/4, Type E Teflon, yellow.
 (H) 003 - 18", 7/34 strand, #26 AWG, MIL-W-16878/4, Type E Teflon, color coded to MIL-STD-681 System I.
 (L) 1 - 1/2" uninsulated solid #25 AWG gold plated copper.
 (L) 2 - 1" uninsulated solid #25 AWG gold plated copper.

Hardware

G - Cable nut and grip (MIKQ plug only)
 N - Nut only (MIKQ plug only)

NOTE: Contact types cannot be interchanged between shell styles.



Contact Arrangements

Face View, Pin Side-(Male Twist Pin Contacts)

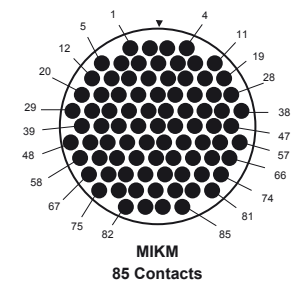
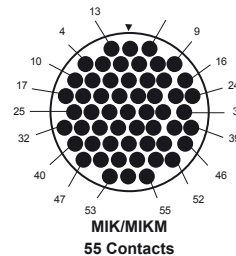
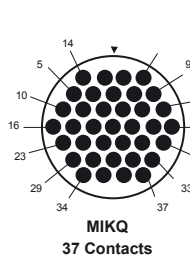
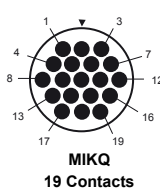

Cavity identification numbers are for reference only, they do not appear on connectors.



Dimensions shown in mm
 Specifications and dimensions subject to change

www.ittcannon.com

Microminiature Circular - .050" Contact Spacing

MIK

MIK Connectors accommodate up to 55 contacts on .050 (1.27) centers (equivalent to 420 contacts per square inch). Five keyway polarization prevents cross plugging. The threaded coupling nuts provide strong, reliable coupling. MIK receptacles can be either front or back panel mounted; in back mounting applications, panel thickness of up to 3/32" can be used on larger sizes. Maximum temperature range -55°C to +125°C. Standard MIK connectors are available in two shell sizes, accommodating two contact arrangements pre-wired to your specific requirements.

Specifications

| STANDARD MATERIAL AND FINISHES | | ELECTRO/MECHANICAL FEATURES | |
|--------------------------------|---|-----------------------------|-----------------------------|
| | MIK | | MIKM |
| Shell | Thermoplastic | No of Contacts | 7,55 |
| Coupling Nut | Stainless Steel Passivated | Wire Size | #24 AWG thru #32 AWG |
| Insulator | Glass-reinforced Thermoplastic | Contact Termination | Crimp |
| Contacts | 50 Microinch Gold Plated Copper Alloy | Contact Rating | 3 Amps |
| | | Coupling | Threaded |
| | | Polarization | Keyways |
| | | Contact Spacing | .050 (1.27) Centers |
| | | Shell Styles | 0-Wall Mtg. 6-Straight Plug |

Standard Wire Termination Codes

The following termination codes are listed for your information. For additional codes please refer to Appendix pp.74-76. All wire lengths are minimum.

Harness Type (H)

#26 AWG per MIL-W-16878 Type E, Teflon Stranded

| Length | All Yellow | Color Coded |
|--------------|------------|-------------|
| 3 (76.2) | 020 | 027 |
| 6 (152.4) | 019 | 016 |
| 8 (203.2) | 026 | 034 |
| 10 (254.0) | 029 | 025 |
| 12 (304.8) | 028 | 002 |
| 18 (457.2) | 001 | 003 |
| 20 (508.0) | 038 | 023 |
| 24 (609.6) | 009 | 004 |
| 30 (762.0) | 010 | 005 |
| 36 (914.4) | 011 | 006 |
| 48 (1219.2) | 013 | 048 |
| 72 (1828.8) | 017 | 046 |
| 120 (3048.0) | 042 | 041 |

Microminiature Circular - .050" Contact Spacing

MIK

Shell Dimensions

MIK (Rear Panel Mount Thickness - see Tabulation "T")

Weight given is 1/2" uninsulated, solid #25 AWG gold plated copper pigtails

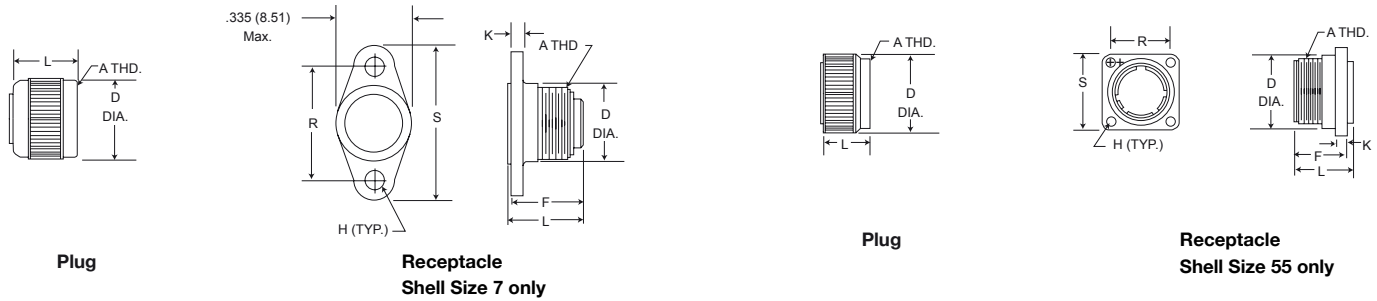

Plug

| Part Number By Shell Size | A Thread | D Max. | L Max. | Avg. Weight** (oz) (gm.) ± 5% |
|------------------------------|---------------|--------------|--------------|----------------------------------|
| MIK6-7P | 5/16-24UNF-2B | .375 (9.52) | .315 (8.00) | .054 (1.54) |
| MIK6-55P | 9/16-24UNF-2A | .755 (19.18) | .460 (11.68) | .202 (5.72) |

Receptacle

| Part Number By Shell Size | A Thread | D ± .010 (0.25) | F Max. | H ± .003 (0.08) | K ± .010 (0.25) | L Max. | R ± .005 (0.13) | S Max. | T Max. | Avg. Weight oz. (gm.) ± 5% |
|------------------------------|---------------|-----------------------|--------------|-----------------------|-----------------------|--------------|-----------------------|--------------|-------------|-------------------------------|
| MIK0-7S | 5/16-24UNF-2B | .325 (8.26) | .315 (8.00) | .078 (1.98) | .062 (1.57) | .355 (9.02) | .460 (11.68) | .630 (16.00) | .032 (0.81) | .022 (.635) |
| MIK0-55S | 9/16-24UNF-2A | .625 (15.88) | .440 (11.18) | .089 (2.26) | .100 (2.54) | .495 (12.57) | .580 (14.73) | .760 (19.30) | .062 (1.57) | .134 (3.81) |

Microminiature Circular - .050" Contact Spacing

MIKM



Cannon's MIKM Microminiature Circular Connector is designed with a steel shell and receptacle for improved ruggedness and RFI resistance. It accommodates up to 55 contacts on .050 (1.27) centers (equivalent to 420 contacts per square inch) and features five keyway polarization to prevent cross plugging. The threaded coupling nuts offer strong, reliable coupling. MIKM receptacles can be either front or back panel mounted; in back mounting applications, panel thickness of up to 3/32" can be used on the larger sizes. Maximum temperature range - 55°C to + 125°C.

Specifications

| STANDARD MATERIAL AND FINISHES | | ELECTRO/MECHANICAL FEATURES | |
|--------------------------------|---|-----------------------------|-----------------------------|
| | MIK | | MIKM |
| Shell | Stainless Steel | No. of Contacts | 7,55, 85 |
| Coupling Nut | Stainless Steel Passivated | Wire Size | #24 AWG thru #32 AWG |
| Insulator | Glass-reinforced Thermoplastic | Contact Termination | Crimp |
| Contacts | 50 Microinch Gold Plated Copper Alloy | Contact Rating | 3 Amps |
| | | Coupling | Threaded |
| | | Polarization | Keyways |
| | | Contact Spacing | .050 (1.27) Centers |
| | | Shell Styles | 0-Wall Mtg. 6-Straight Plug |

Standard Wire Termination Codes

The following termination codes are listed for your information. For additional codes please refer to Appendix on pp. 74-76. All wire lengths are minimum.

Harness Type (H)

#26 AWG per MIL-W-16878 Type E, Teflon Stranded

| Length | -All Yellow | Color Coded |
|--------------|-------------|-------------|
| 3 (76.2) | 020 | 027 |
| 6 (152.4) | 019 | 016 |
| 8 (203.2) | 026 | 034 |
| 10 (254.0) | 029 | 025 |
| 12 (304.8) | 028 | 002 |
| 18 (457.2) | 001 | 003 |
| 20 (508.0) | 038 | 023 |
| 24 (609.6) | 009 | 004 |
| 30 (762.0) | 010 | 005 |
| 36 (914.4) | 011 | 006 |
| 48 (1219.2) | 013 | 048 |
| 72 (1828.8) | 017 | 046 |
| 120 (3048.0) | 042 | 041 |

Microminiature Circular - .050" Contact Spacing

MIKM

Shell Dimensions

MIKM (Rear Panel Mount Thickness .335 (8.51) max. - see Tabulation "T")

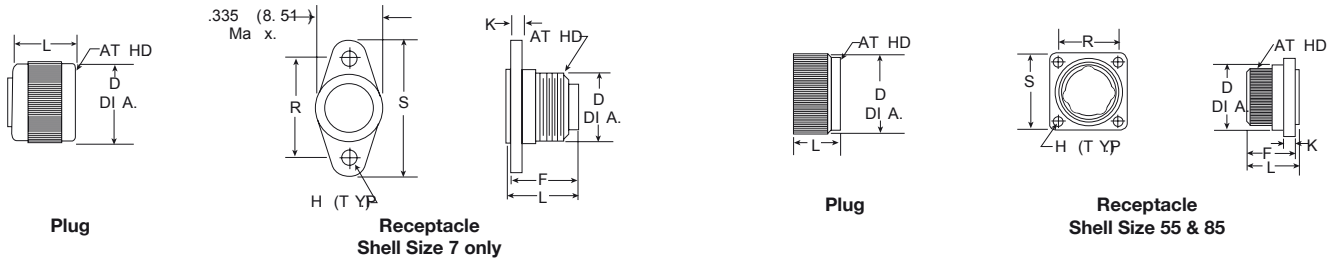

Plug

| Part Number By Shell Size | A Thread | D Max. | L Max. | Avg. Weight oz. (gm.) + 5% |
|------------------------------|-----------------|--------------|--------------|-------------------------------|
| MIK6-7P | 5/16-24UNF-2A | .375 (9.52) | .315 (8.00) | .054 (1.54) |
| MIK6-55P | 5/8-24UNEF-2B | .755 (19.18) | .440 (11.18) | .333 (9.44) |
| MIKM6-85P | 11/16-24UNEF-2B | .860 (21.84) | .460 (11.68) | .419 (11.88) |

Receptacle

| Part Number By Shell Size | A Thread | D | F Max. | H ± .003 (0.08) | K | L Max. | R ± .005 (0.13) | S Max. | T Max. | Avg. Weight oz. (gm.) ± 5% |
|------------------------------|-----------------|--------------|--------------|-----------------------|-------------|--------------|-----------------------|--------------|-------------|-------------------------------|
| MIK0-7S | 5/16-24UNF-2A | .325 (8.26) | .320 (8.13) | .078 (1.98) | .062 (1.57) | .400 (10.16) | .460 (11.68) | .630 (16.00) | .032 (0.81) | .051 (1.45) |
| MIK0-55S | 5/8-24UNEF-2A | .625 (15.88) | .440 (11.18) | .091 (2.31) | .062 (1.57) | .490 (12.45) | .580 (14.73) | .760 (19.30) | .125 (3.18) | .269 (7.62) |
| MIKM0-85S | 11/16-24UNEF-2A | .745 (18.92) | .440 (11.18) | .091 (2.31) | .062 (1.57) | .490 (12.45) | .674 (17.12) | .845 (21.46) | .125 (3.18) | .346 (9.80) |



Dimensions shown in mm
Specifications and dimensions subject to change

www.ittcannon.com

Microminiature Circular - .050" Contact Spacing

MIKQ



Cannon's MIKQ Microminiature Circular Connectors feature a quick disconnect metal shell and a receptacle version that, when engaged, can be instantly disconnected while still providing a solid lock. Applications include commercial TV cameras, portable radios, military gun sights, airborne landing systems and medical equipment. Maximum temperature range is -55°C to +125°C.

Specifications

| STANDARD MATERIAL AND FINISHES | | ELECTRO/MECHANICAL FEATURES | |
|--------------------------------|---|-----------------------------|---|
| | MIKQ | | MIKQ |
| Shell | Brass | No. of Contacts | 7, 19, 37 |
| Coupling Nut | Brass, Electroless Nickel Plated* | Wire Size | #24 AWG thru #32 AWG |
| Insulator | Glass-reinforced Thermoplastic | Contact Termination | Crimp |
| Contacts | 50 Microinch Gold Plated Copper Alloy | Contact Rating | 3 Amps |
| | | Coupling | Push/Pull |
| | | Polarization | Keyways |
| | | Contact Spacing | .050 (1.27) Centers |
| | | Shell Styles | 7-Jam Nut 6-Straight Plug 9-Rear Panel Mtg. Receptacle |

Shell Dimensions

MIKQ (Front Panel Mounting Type Shown-.093 (2.36) Thickness)

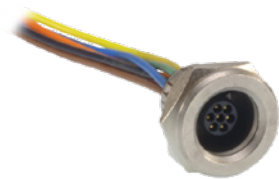
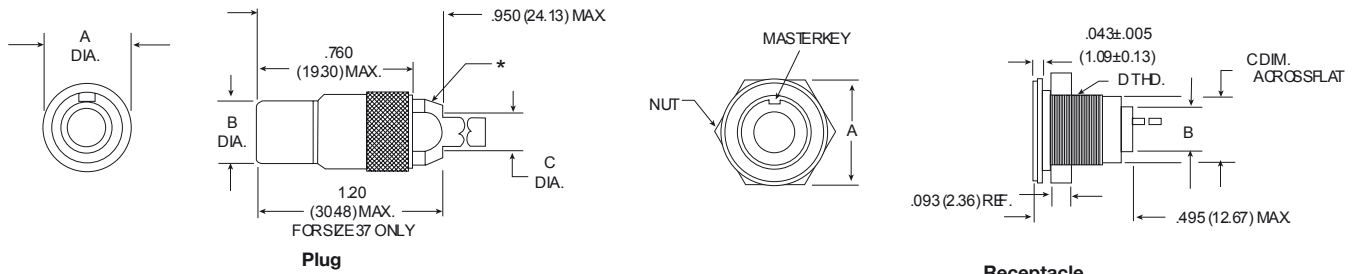

Plug

| Part Number By Shell Size | A Max. | B Max. | C Ref. | Avg. Weight oz. (gm.) ±5% |
|---------------------------|--------------|--------------|-------------|---------------------------|
| MIKQ6-7S | .385 (9.78) | .305 (7.75) | .180 (4.57) | .214 (6.08) |
| MIKQ6-19S | .515 (13.08) | .405 (10.29) | .260 (6.60) | .376 (10.70) |
| MIKQ6-37S | .760 (19.30) | .635 (16.13) | .350 (8.89) | .714 (20.23) |

*Std. Conn. not supplied with Cable Nut & Grip, See Mod Codes. Lanyard Release Is Available. Consult factory.

Receptacle

| Part Number By Shell Size | A Max. | B Max. | C Max. | D Thread | Avg. Weight oz. (gm.) ±5% |
|---------------------------|--------------|--------------|--------------|---------------|---------------------------|
| MIKQ7-7S | .510 (12.95) | .245 (6.22) | .359 (9.12) | 3/8-32UNEF-2A | .128 (3.63) |
| MIKQ7-19P | .575 (14.60) | .345 (8.76) | .470 (11.94) | 1/2-28UNEF-2A | .214 (6.08) |
| MIKQ7-37P | .855 (21.71) | .520 (13.20) | .740 (18.80) | 3/4-20UNEF-2A | .300 (8.52) |

MIKQ Front Panel Mounting

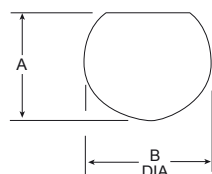

Front Panel Mounting-MIKQ7

| Shell Size | A ± .005 (0.13) | B DIA. |
|------------|-----------------|--------------|
| MIKQ7-7P | .364 (9.24) | .390 (9.91) |
| MIKQ7-19P | .475 (12.06) | .515 (13.08) |
| MIKQ7-37P | .740 (18.78) | .755 (19.17) |

Dimensions shown in mm
Specifications and dimensions subject to change

www.ittcannon.com



Microstrips .050" Contact Spacing

MT

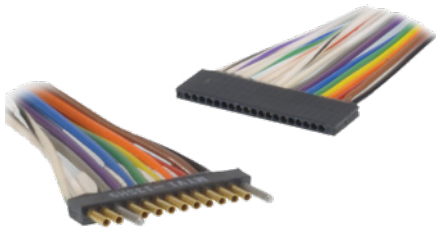

Cannon Microstrips are available in three termination styles: solder cup, pigtail harness and printed circuit leads. The MicroPin Contact System assures maximum performance in a minimum design package. Available with latches or guide pins, our Microstrips provide an extremely dense and reliable interconnection and offer greater application flexibility

Product Features

- High Performance MicroPin Contact System
- High-density .050" contact spacing
- Pre-wired for ease of installation
- Fully potted wire terminations
- Guide pins for alignment and polarizing
- Quick-disconnect latches
- 3 Amp current rating
- Precision crimp terminations
- Solder cup, pigtail or printed circuit terminations
- Surface mount leads

MicroPin Contact System

The Cannon MicroPin Contact System offers uncompromised performance in downsized interconnects. The beryllium copper pin contact is fully recessed in the insulator, assuring positive contact alignment and robust performance. The socket contact is precision machined from high strength copper alloy and features a smooth lead-in chamfer.

The MicroPin features seven points of electrical contact. This contact system assures high normal force, excellent wipe and superior shock and vibration performance.

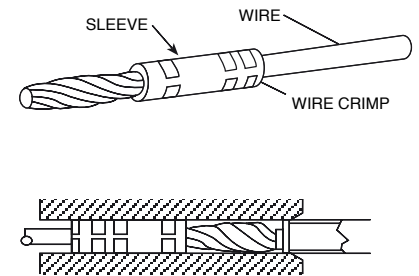

Specifications

| | |
|---------------------------------|---|
| Current Rating | 3 Amps max |
| Dielectric Withstanding Voltage | 600 VAC @ sea level; 300 VAC @ 70,000 feet altitude |
| Insulation Resistance | 5000 megohms min. |
| Contact Resistance | 8 milliohms max. |
| Operating Temperature | MTV polyester -56°C to +125°C; MTB diallyl phthalate -55°C to +150°C |
| Durability | 500 cycles min. |
| Shock/Vibration | 20 G's |
| Connector Mating Force | (8 oz.) x (# of contacts) |
| Latch Retention | 5 lbs. min. |
| Wire Size | #26 AWG insulated wire, #25 AWG uninsulated solid wire. MT strips will also accommodate #24 AWG through #32 AWG. For other wiring options contact the factory for ordering information. General Performance requirements in accordance with MIL-DTL-83513 |

Materials and Finishes

| | |
|--------------------------------------|---|
| Insulator | MTV: Glass-filled polyester per MIL-M-24519; MTB: Glass-filled diallyl phthalate per MIL-M-14 |
| Contact | Copper Alloy per MIL-DTL-83513 |
| Contact Finish | 50 Microinches Min. Gold Plated per MIL-G-45204 |
| Insulated Wire | #26 AWG. 19/38 Stranded, silver-plated copper, TFE Teflon insulation per MIL-W-16878/4 |
| Uninsulated Solid Wire | #25 AWG gold-plated copper per QQ-W-343 |
| Potting Material/Contact Encapsulant | Epoxy |
| Latch | 300 series stainless steel, passivated |

Dimensions shown in mm
Specifications and dimensions subject to change

www.ittcannon.com

Microstrips .050" Contact Spacing

MT

How to Order

R MTV1 - 16 P H001 01

RoHS Compliance

Series

MTB1 – High Temperature Diallyl Phthalate 150°C (Recommended for severe environments)
 MTV1 – Polyester 125°C (Recommended for general purpose use), .050" contact spacing
 MTV2 – Polyester 125°C (Recommended for general purpose use), .100" contact spacing

Number of Cavities

2 through 40.

This number is the total number of cavities including guide pins and latches. 40 positions is the maximum recommended size for standard strips, but sizes up to 120 positions are available on request.

Insert Arrangements

P- Pin
 S – Socket

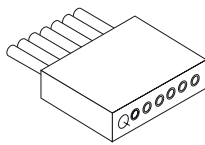

Pin Strip

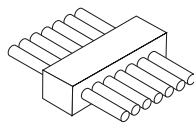

Socket Strip

Termination Style

Solder Cup contacts for customer termination
 S

Pre-wired Pigtails

H067 – Pre-wired pigtail with 18" of insulated Teflon wire per M22759/11, #26 AWG, 19 strand, yellow
 HY01 – Pre-wired pigtail with 18" of insulated Teflon wire per M22759/11, #26 AWG, 19 strand, 10 color repeating

Straight Terminals .018" diameter, gold-plated

L1 – 5" extension
 L2 – 1" extension
 L57 – .190" extension
 L61 – .125" extension



Right Angle Terminals staggered footprint .018" diameter, gold plated

AL57 – .190" extension
 AL61 – .125" extension

Right Angle Terminals .050" in-line footprint .018" diameter, gold plated

BL57 – .190" extension
 BL61 – .125" extension

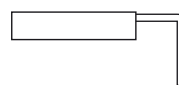

Surface Mount .018" diameter, gold-plated

CL1

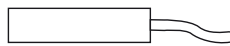

Guide Pin and Latch Options

- 01 – Guide pin installed in end cavities of socket strip. Blank holes in end cavities of pin strip.
- 02 – Guide pin installed in cavity #1 of socket Strip. Blank holes in cavity #1 of pin strip.
- 03 – Spring latches installed in end cavities of socket strip. Latch clips installed in end cavities of pin strip. For use with MTV1 only.
- 04 – Spring latch installed in center cavity of socket strip. Spring latch installed in center cavity of pin strip. For use with MTV1 only.

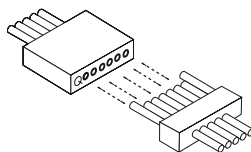

01 Guide Pins In End Cavities

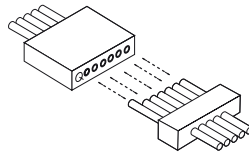

02 Guide Pins In Cavity #1

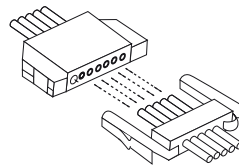

03 End Latches

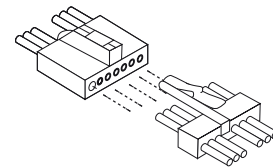

04 Center Latch



Dimensions shown in mm
 Specifications and dimensions subject to change

www.ittcannon.com

Microstrips .050" Contact Spacing

MT

Connector Weights

| | | | | |
|---|--|-----------------|--------|-----------|
| Contact (with std. 1/2" copper pigtails) | | | | .040 gms. |
| | | MTB | pin | .021 gms. |
| | | | socket | .006 gms. |
| Insulator (per contact cavity) | | MTV | pin | .014 gms. |
| | | | socket | .004 gms. |
| Guide Post | | Stainless Steel | | .035 gms. |
| Latch | | Male | | .035 gms. |
| | | Female | | .074 gms. |

Terminal Dimensions

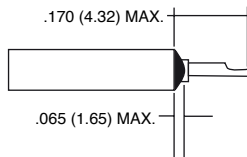

Solder Cup

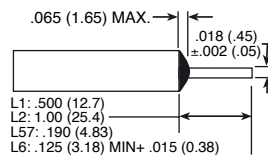

Straight Terminals

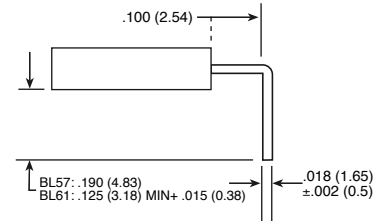

Right Angle Terminals
.050" Centers

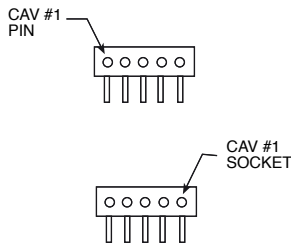

Right Angle Terminals
.100" Spacing Staggered

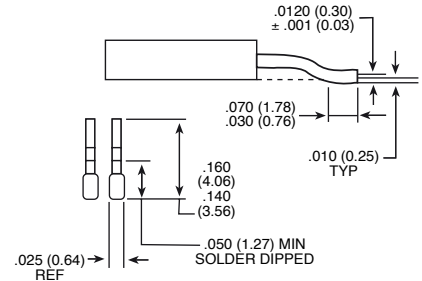
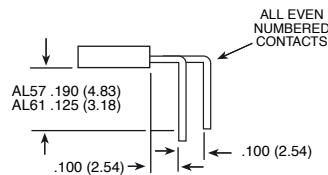

Surface Mount Terminals

Microstrips .050" Contact Spacing

MT

Latch Dimensions

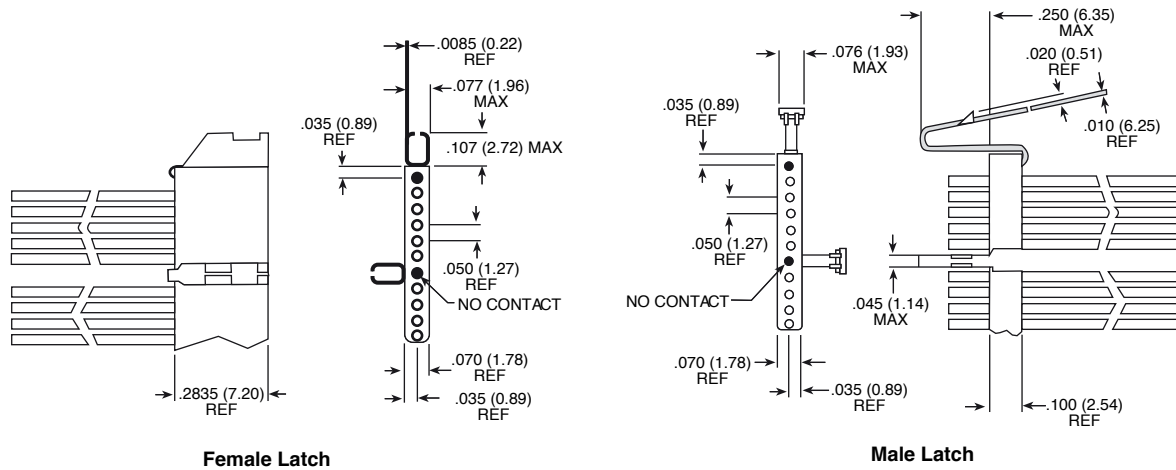

Guide Pin Dimensions

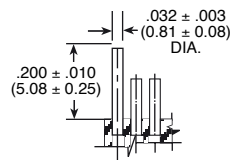

Standard Wire Termination Codes

The following termination codes are listed for your information. For additional codes please refer to Appendix on pp. 74-76. All wire lengths are minimum.

Harness Type (H)

#26 AWG per MIL-W-16878 Type E; Teflon Stranded

| Length | All Yellow | Color Coded |
|--------------|------------|-------------|
| 3 (76.2) | H020 | H027 |
| 6 (152.4) | H019 | H016 |
| 8 (203.2) | H026 | H034 |
| 10 (254.0) | H029 | H025 |
| 12 (304.8) | H028 | H002 |
| 18 (457.2) | H001 | H003 |
| 20 (508.0) | H033 | H023 |
| 24 (609.6) | H009 | H004 |
| 30 (762.0) | H010 | H005 |
| 36 (914.4) | H011 | H006 |
| 48 (1219.2) | H013 | H048 |
| 72 (1828.8) | H017 | H046 |
| 120 (3048.0) | H042 | H041 |

Solid Uninsulated Type - (L)

#25 AWG Gold Plated Copper

| Termination Code | Length |
|------------------|---------------|
| L61 | .125 (3.18) |
| L56 | .150 (3.81) |
| L57 | .190 (4.83) |
| L39 | .250 (6.35) |
| L58 | .375 (9.52) |
| L1 | .500 (12.70) |
| L14 | .750 (19.05) |
| L2 | 1.000 (25.40) |
| L7 | 1.500 (38.10) |
| L6 | 2.000 (50.80) |
| L16 | 2.500 (63.50) |
| L10 | 3.000 (76.20) |



Dimensions shown in mm
Specifications and dimensions subject to change

www.ittcannon.com

Microminiature Strip - .100/.050" Contact Spacing

MT

Polarization

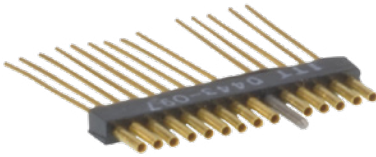

Modification code "-01" in the Microminiature Strip part number refers to guide posts, which are located on both ends of the socket side of the 50-MIL STRIP connector and feature empty cavities on the pin side to accept the guide posts. Although in many cases it is not necessary to polarize 50-MIL STRIP connectors, there are several ways to prevent cross plugging. One method is the use of guide posts that can be located in specified cavities to ensure the contacts will align when these posts are positioned before mating.

MTB1 and MTV1 - .050 (1.27) Contact Centers

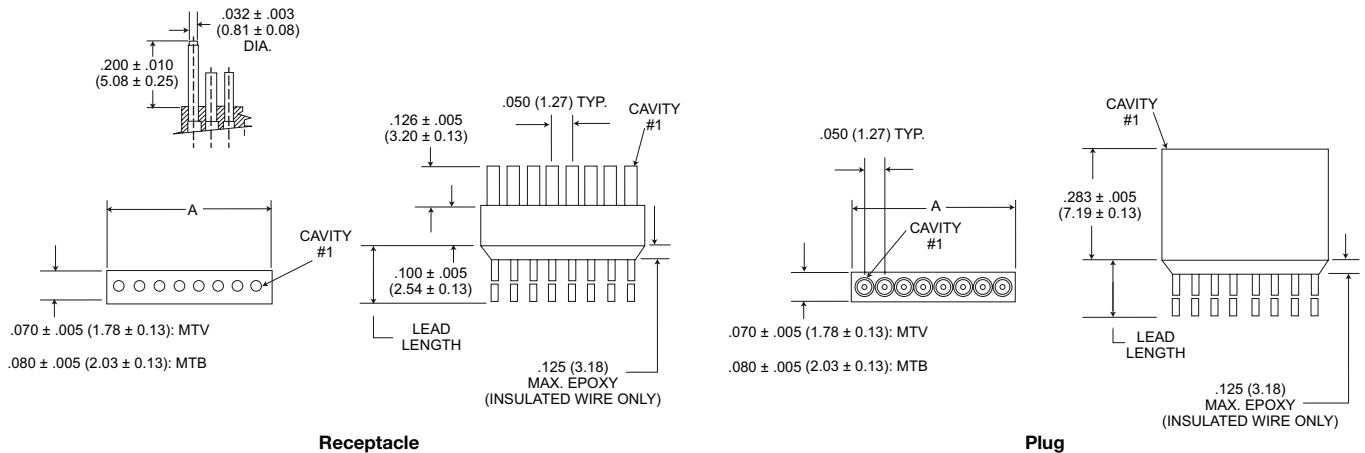

| Part Number By Size | A ± .015 (0.38) | Part Number By Size | A ± .015 (0.38) | Part Number By Size | A ± .015 (0.38) | Part Number By Size | A ± .015 (0.38) | Part Number By Size | A ± .015 (0.38) | Part Number By Size | A ± .015 (0.38) |
|---------------------|-----------------|---------------------|-----------------|---------------------|-----------------|---------------------|-----------------|---------------------|-----------------|---------------------|-----------------|
| MT*1-1** | .070 (1.78) | MT*1-21** | 1.070 (27.18) | MT*1-41** | 2.070 (52.58) | MT*1-61** | 3.070 (77.98) | MT*1-81** | 4.070 (103.38) | MT*1-101** | 5.070 (128.78) |
| MT*1-2** | .120 (3.05) | MT*1-22** | 1.120 (28.45) | MT*1-42** | 2.120 (53.85) | MT*1-62** | 3.120 (79.25) | MT*1-82** | 4.120 (104.65) | MT*1-102** | 5.120 (130.05) |
| MT*1-3** | .170 (4.32) | MT*1-23** | 1.170 (29.72) | MT*1-43** | 2.170 (55.12) | MT*1-63** | 3.170 (80.52) | MT*1-83** | 4.170 (105.92) | MT*1-103** | 5.170 (131.32) |
| MT*1-4** | .220 (5.59) | MT*1-24** | 1.220 (30.99) | MT*1-44** | 2.220 (56.39) | MT*1-64** | 3.220 (81.79) | MT*1-84** | 4.220 (107.19) | MT*1-104** | 5.220 (132.59) |
| MT*1-5** | .270 (6.85) | MT*1-25** | 1.270 (32.36) | MT*1-45** | 2.270 (57.66) | MT*1-65** | 3.270 (83.06) | MT*1-85** | 4.270 (108.46) | MT*1-105** | 5.270 (133.86) |
| MT*1-6** | .320 (8.13) | MT*1-26** | 1.320 (33.53) | MT*1-46** | 2.320 (58.93) | MT*1-66** | 3.320 (84.33) | MT*1-86** | 4.320 (109.73) | MT*1-106** | 5.320 (135.13) |
| MT*1-7** | .370 (9.40) | MT*1-27** | 1.370 (34.80) | MT*1-47** | 2.370 (60.20) | MT*1-67** | 3.370 (85.60) | MT*1-87** | 4.370 (111.00) | MT*1-107** | 5.370 (136.40) |
| MT*1-8** | .420 (10.67) | MT*1-28** | 1.420 (36.07) | MT*1-48** | 2.420 (61.47) | MT*1-68** | 3.420 (86.87) | MT*1-88** | 4.420 (112.27) | MT*1-108** | 5.420 (137.67) |
| MT*1-9** | .470 (11.94) | MT*1-29** | 1.470 (37.34) | MT*1-49** | 2.470 (62.74) | MT*1-69** | 3.470 (88.14) | MT*1-89** | 4.470 (113.54) | MT*1-109** | 5.470 (138.94) |
| MT*1-10** | .520 (13.20) | MT*1-30** | 1.520 (38.61) | MT*1-50** | 2.520 (64.01) | MT*1-70** | 3.520 (89.41) | MT*1-90** | 4.520 (114.81) | MT*1-110** | 5.520 (140.21) |
| MT*1-11** | .570 (14.48) | MT*1-31** | 1.570 (39.88) | MT*1-51** | 2.570 (65.28) | MT*1-71** | 3.570 (90.68) | MT*1-91** | 4.570 (116.08) | MT*1-111** | 5.570 (141.48) |
| MT*1-12** | .620 (15.75) | MT*1-32** | 1.620 (41.15) | MT*1-52** | 2.620 (66.55) | MT*1-72** | 3.620 (91.95) | MT*1-92** | 4.620 (117.35) | MT*1-112** | 5.620 (142.75) |
| MT*1-13** | .670 (17.02) | MT*1-33** | 1.670 (42.42) | MT*1-53** | 2.670 (67.82) | MT*1-73** | 3.670 (93.22) | MT*1-93** | 4.670 (118.62) | MT*1-113** | 5.670 (144.02) |
| MT*1-14** | .720 (18.29) | MT*1-34** | 1.720 (43.69) | MT*1-54** | 2.720 (69.09) | MT*1-74** | 3.720 (94.49) | MT*1-94** | 4.720 (119.89) | MT*1-114** | 5.720 (145.29) |
| MT*1-15** | .770 (19.56) | MT*1-35** | 1.770 (44.96) | MT*1-55** | 2.770 (70.36) | MT*1-75** | 3.770 (95.76) | MT*1-95** | 4.770 (121.16) | MT*1-115** | 5.770 (146.56) |
| MT*1-16** | .820 (20.83) | MT*1-36** | 1.820 (46.23) | MT*1-56** | 2.820 (71.63) | MT*1-76** | 3.820 (97.03) | MT*1-96** | 4.820 (122.43) | MT*1-116** | 5.820 (147.83) |
| MT*1-17** | .870 (22.10) | MT*1-37** | 1.870 (47.50) | MT*1-57** | 2.870 (72.90) | MT*1-77** | 3.870 (98.30) | MT*1-97** | 4.870 (123.70) | MT*1-117** | 5.870 (149.10) |
| MT*1-18** | .920 (23.37) | MT*1-38** | 1.920 (48.77) | MT*1-58** | 2.920 (74.17) | MT*1-78** | 3.920 (99.57) | MT*1-98** | 4.920 (124.97) | MT*1-118** | 5.920 (150.37) |
| MT*1-19** | .970 (24.64) | MT*1-39** | 1.970 (50.04) | MT*1-59** | 2.970 (75.44) | MT*1-79** | 3.970 (100.84) | MT*1-99** | 4.970 (126.24) | MT*1-119** | 5.970 (151.64) |
| MT*1-20** | 1.020 (25.91) | MT*1-40** | 2.020 (51.31) | MT*1-60** | 3.020 (76.71) | MT*1-80** | 4.020 (102.11) | MT*1-100** | 5.020 (127.50) | MT*1-120** | 6.020 (152.91) |

*For jackpost, add letter "P" or "M7" for sizes 9-51, "M17" for size 100.

Microminiature Strip - .100/.050" Contact Spacing

MT

MTB2 and MTV2 - .100 (2.54) Contact Centers

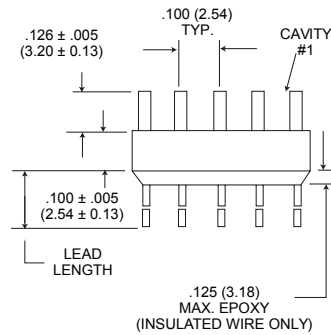
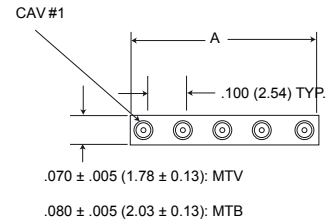
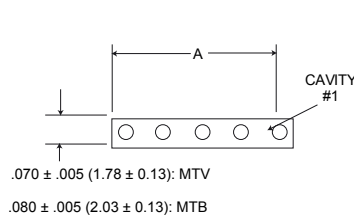
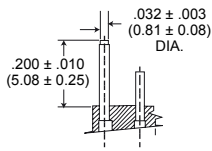

Receptacle

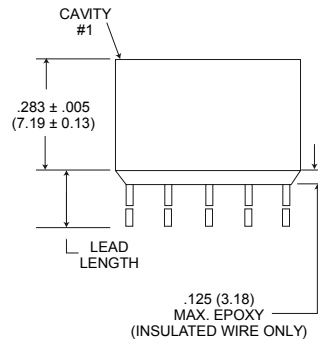

Plug

| Part Number By Size | A ± .015 (0.38) | Part Number By Size | A ± .015 (0.38) |
|---------------------|--------------------|---------------------|--------------------|
| MT*2-1** | .070 (1.78) | MT*2-31** | 3.070 (77.98) |
| MT*2-2** | .170 (4.32) | MT*2-32** | 3.170 (80.52) |
| MT*2-3** | .270 (6.86) | MT*2-33** | 3.270 (83.06) |
| MT*2-4** | .370 (9.40) | MT*2-34** | 3.370 (85.60) |
| MT*2-5** | .470 (11.94) | MT*2-35** | 3.470 (88.14) |
| MT*2-6** | .570 (14.48) | MT*2-36** | 3.570 (90.68) |
| MT*2-7** | .670 (17.02) | MT*2-37** | 3.670 (93.22) |
| MT*2-8** | .770 (19.56) | MT*2-38** | 3.770 (95.76) |
| MT*2-9** | .870 (22.10) | MT*2-39** | 3.870 (98.30) |
| MT*2-10** | .970 (24.64) | MT*2-40** | 3.970 (100.84) |
| MT*2-11** | 1.070 (27.18) | MT*2-41** | 4.070 (103.38) |
| MT*2-12** | 1.170 (29.72) | MT*2-42** | 4.170 (105.92) |
| MT*2-13** | 1.270 (32.26) | MT*2-43** | 4.270 (108.46) |
| MT*2-14** | 1.370 (34.80) | MT*2-44** | 4.370 (111.00) |
| MT*2-15** | 1.470 (37.34) | MT*2-45** | 4.470 (113.54) |
| MT*2-16** | 1.570 (39.88) | MT*2-46** | 4.570 (116.08) |
| MT*2-17** | 1.670 (42.42) | MT*2-47** | 4.670 (118.62) |
| MT*2-18** | 1.770 (44.96) | MT*2-48** | 4.770 (121.16) |
| MT*2-19** | 1.870 (47.50) | MT*2-49** | 4.870 (123.70) |
| MT*2-20** | 1.970 (50.04) | MT*2-50** | 4.970 (126.24) |
| MT*2*21** | 2.070 (52.58) | MT*2*51** | 5.070 (128.78) |
| MT*2-22** | 2.170 (55.12) | MT*2-52** | 5.170 (131.32) |
| MT*2-23** | 2.270 (57.66) | MT*2-53** | 5.270 (133.86) |
| MT*2-24** | 2.370 (60.20) | MT*2-54** | 5.370 (136.40) |
| MT*2-25** | 2.470 (62.74) | MT*2-55** | 5.470 (138.94) |
| MT*2-26** | 2.570 (65.28) | MT*2-56** | 5.570 (141.48) |
| MT*2-27** | 2.670 (67.82) | MT*2-57** | 5.670 (144.02) |
| MT*2-28** | 2.770 (70.36) | MT*2-58** | 5.770 (146.56) |
| MT*2-29** | 2.870 (72.90) | MT*2-59** | 5.870 (149.10) |
| MT*2-30** | 2.970 (75.44) | MT*2-60** | 5.970 (151.64) |

Micro Edgeboard - .050" Contact Spacing

MEB

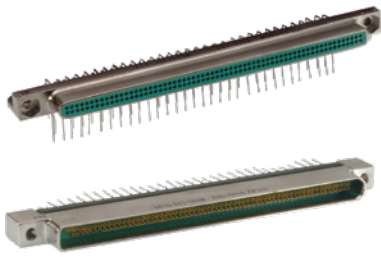

Cannon's Micro Edgeboard (MEB) Connector Series incorporates the proven Micro-Pin / Micro-Socket contact, which features an outstanding record of reliability and performance. Our MEB features machined aluminum shells for ruggedness, diallyl phthalate insulator for top electrical performance and a 36-position polarization key system to prevent cross plugging. Contacts are on .050 (1.27) center spacing. Termination types include 90° or right angle pigtailed for multi-layered PC boards and "coke bottle" termination for double-sided PC boards. Harnessing capability is available for both pin and socket sides. The MEB, including the SBR 90° or right angle variation available for multi-layer boards, can be mounted on the female (daughter) side of double or single-sided PC boards. The mating male (mother) board side can have the terminations formed to meet the application demands. Conforms to MIL-C-55302/120 thru 123 (not qualified).

Specifications

MATERIAL AND FINISHES

| | |
|--------------------------|---|
| Shell | 6061-T6 Aluminum Alloy per QQ-A-200/8 or QQ-A-225/8, electroless nickel per SAE AMS-C-26074, Class 4, except .0010 to .0015 (0.03 to 0.04) thick or conversion coating per MIL-C-5541, Class 3, color gold. |
| Contact, Pin and Socket: | Copper Alloy, 50 microinch gold per ASTM B488, Type II, Code C, Class 1.25 |
| Jackscrew/Jackpost: | 303 stainless steel, passivated per QQ-P-35. |
| Insulator: | Glass-filled diallyl phthalate per MIL-M-14, Type SDG-F, color green Polyester per MIL-M-24519, Type GPT-30F, color black available for MEB-128 upon request. |

TERMINATION TYPES

Consult factory for stranded wire lead modifications codes.

MECHANICAL FEATURES

| | |
|--------------------------|--|
| Size or Length: | 2 sizes |
| Coupling: | Friction/Jackscrew |
| Polarization: | Shells, polarizing keys (36 positions) |
| Contact Spacing Centers: | .050 (1.27) |
| Polarization | Keyways |
| Shell Styles: | Plug and receptacle |

How to Order



| | |
|---------------------------------|--|
| RoHS Compliance | |
| Series Prefix | |
| Contact Spacing | |
| Layout | |
| Contact Type | |
| Termination Modification | |
| Lead Length | |
| Other Modifications | |

Series Prefix

MEB - Micro edgeboard, plug with twist pin contacts or recept. with microsocket contacts.

Contact Spacing

1 - .050 (1.27) centers 128/184
 2 - .100 (2.54) centers 64/92
 (alternate contact holes)

Layout

64, 92, 128, 184

Contact Type

P - Pin
 S - Socket

Termination Modifications

L - Uninsulated solid wire
 H - Insulated stranded round harness wire
 S - Solder pots
 BR - PC board right angle, socket side only

Lead Length

Consult factory for wire lead modification codes.

Other Modifications

Consult factory



Dimensions shown in mm
 Specifications and dimensions subject to change

www.itcannon.com



Micro Edgeboard - .050" Contact Spacing

MEB

Plug (Mother Board)

MEB-128P

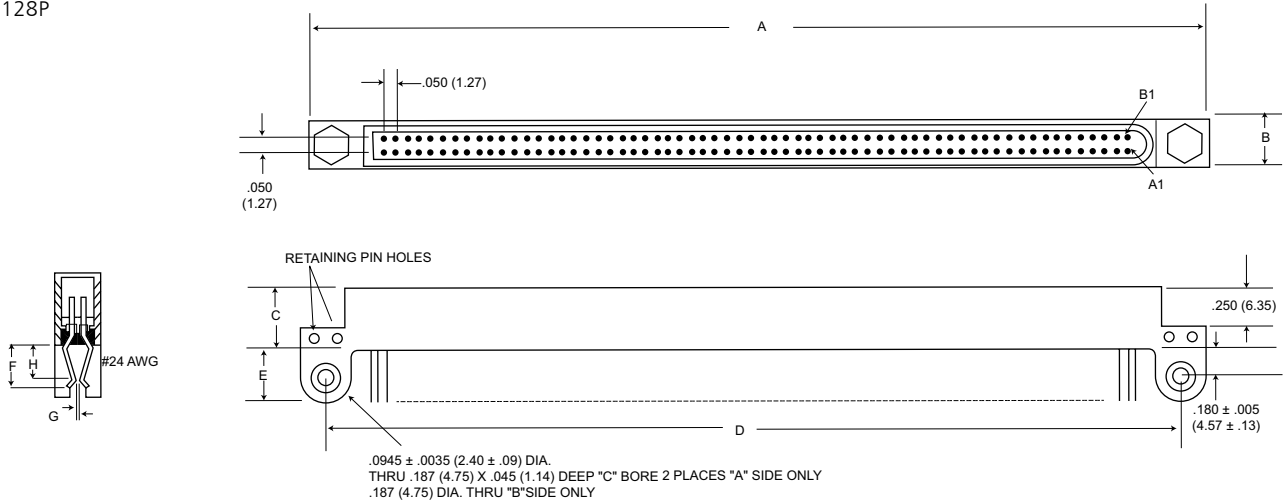

| Part No. | Weight oz. (gm.) Max. | A ±.015 (0.38) | B ±.010 (0.25) | C ±.010 (0.25) | D ±.010 (0.25) | E ±.010 (0.25) | F Max. | G* Max. | H ±.020 (0.51) |
|----------|--------------------------|-------------------|-------------------|-------------------|-------------------|-------------------|-------------|-------------|-------------------|
| 128P | .5 (14.17) | 3.950 (100.33) | .250 (6.35) | .400 (10.16) | 3.700 (93.98) | .300 (7.62) | .280 (7.11) | .030 (0.76) | .200 (5.08) |
| 128PBR | .5 (14.17) | | | | | | | | |

*Will accept up to .093 (2.36) thick P.C. Board with shell modifications.

Receptacle (Daughter Board)

MEB1-12BS

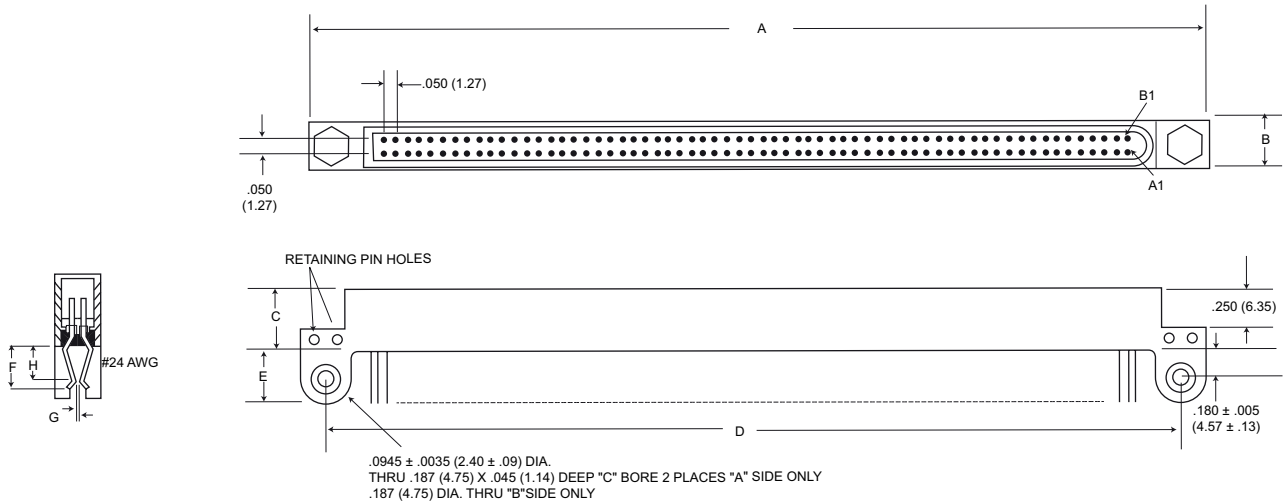

| Part No. | Weight oz. (gm.) Max. | A ±.015 (0.38) | B ±.010 (0.25) | C ±.010 (0.25) | D ±.010 (0.25) | E ±.010 (0.25) | F Max. | G* Max. | H ±.020 (0.51) |
|----------|--------------------------|-------------------|-------------------|-------------------|-------------------|-------------------|-------------|-------------|-------------------|
| 128S | .5 (14.17) | 3.950 (100.33) | .250 (6.35) | .400 (10.16) | 3.700 (93.98) | .300 (7.62) | .280 (7.11) | .030 (0.76) | .200 (5.08) |
| 128SBR | .5 (14.17) | | | | | | | | |

*Will accept up to .093 (2.36) thick P.C. Board with shell modifications.



Dimensions shown in mm
Specifications and dimensions subject to change

www.ittcannon.com

Micro Edgeboard - .050" Contact Spacing

MEB

Plug (Mother Board)

MEB1-184P

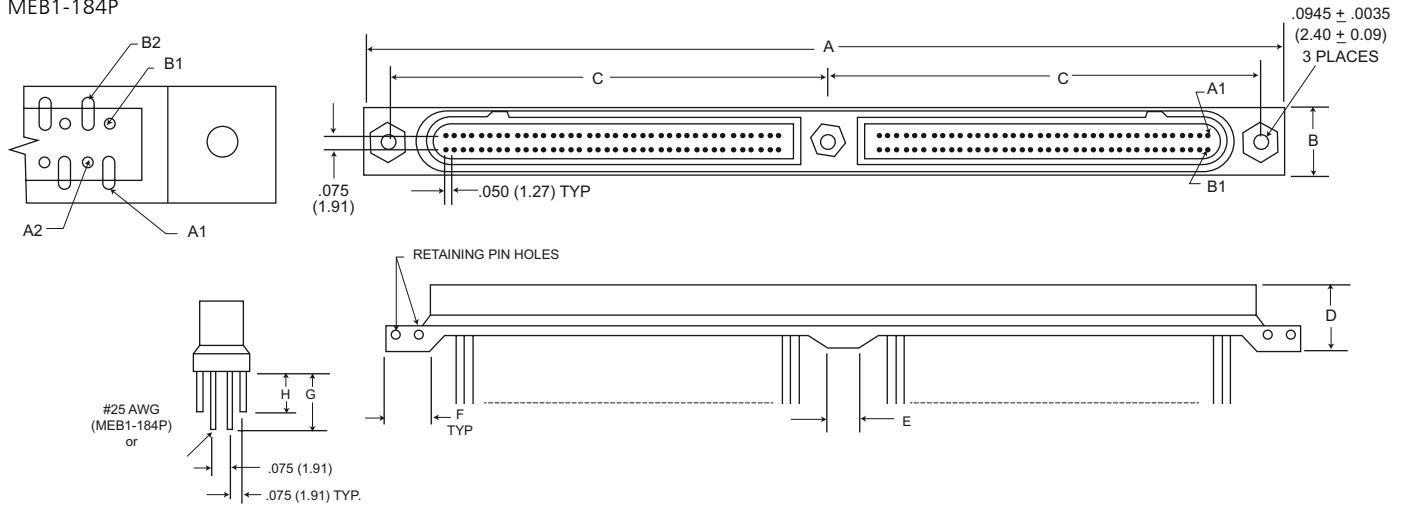

| Part No. | Weight oz. (gm.) Max. | A ±.015 (0.38) | B ±.010 (0.25) | C ±.005 (0.13) | D ±.010 (0.25) | E ±.010 (0.25) | F ±.010 (0.25) | G* ±.010 (0.25) | H ±.025 (0.64) |
|----------|--------------------------|-------------------|-------------------|-------------------|-------------------|-------------------|-------------------|--------------------|-------------------|
| 184P | 1.0 (28.35) | 5.800 (147.32) | .343 (8.71) | 2.775 (70.49) | .400 (10.16) | .250 (6.35) | .280 (7.11) | .350 (8.89) | .275 (6.99) |

*Will accept up to .093 (2.36) thick P.C. Board with shell modifications.

Receptacle (Daughter Board)

MEB1-184S

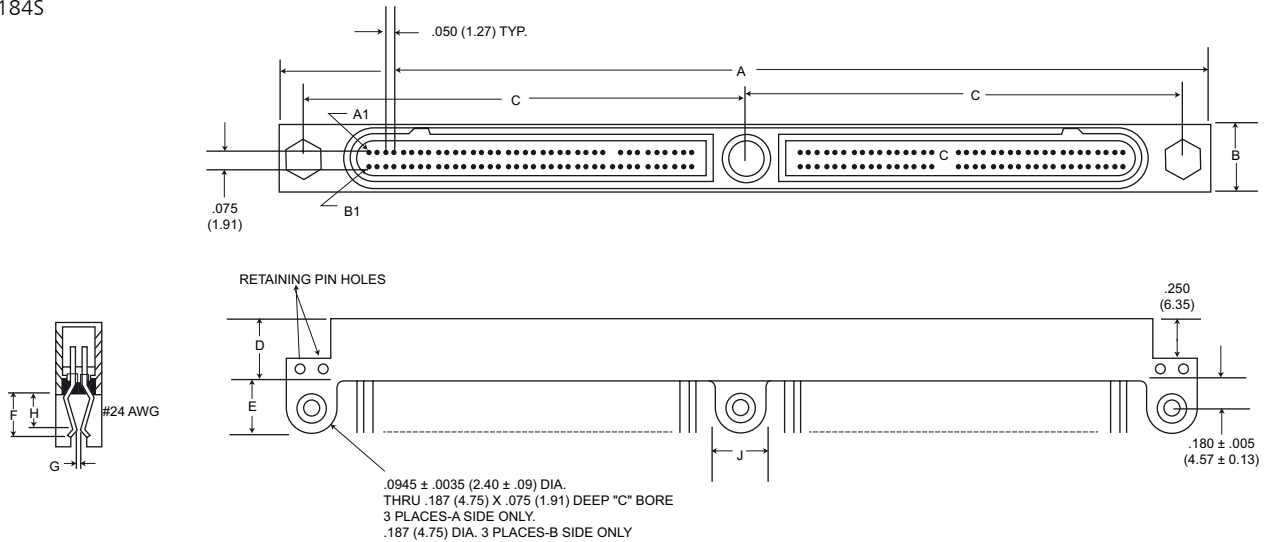

| Part No. | Weight oz. (gm.) Max. | A ±.015 (0.38) | B ±.010 (0.25) | C ±.005 (0.13) | D ±.010 (0.25) | E ±.010 (0.25) | F Max. | G* Max. | H ±.020 (0.51) | H ±.010 (0.25) |
|----------|--------------------------|-------------------|-------------------|-------------------|-------------------|-------------------|-------------|-------------|-------------------|-------------------|
| 184S | 1.0 (28.35) | 5.800 (147.32) | .343 (8.71) | 2.775 (70.49) | .400 (10.16) | .300 (7.62) | .280 (7.11) | .030 (0.76) | .200 (5.08) | .250 (6.35) |
| 184SBR | 1.0 (28.35) | | | | | | | | | .250 (6.35) |

All round pigtail #25 AWG wire termination designs available for the MEB1-12B receptacle will apply on the MEB1-184 series also.

*Will accept up to .093 (2.36) thick P.C. Board with shell modifications.

Dimensions shown in mm
Specifications and dimensions subject to change

www.itccannon.com

Micro Edgeboard - .050" Contact Spacing

MEB

PC Board Right Angle

MEB1-128SBR

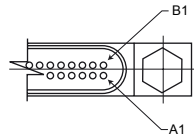
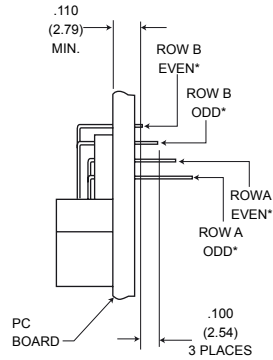
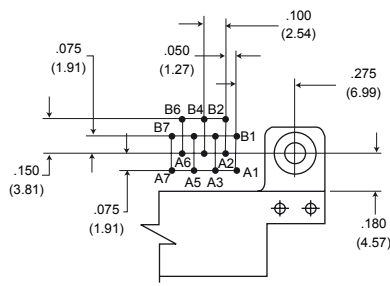

Keying Accessory - Key and Retaining Pin

Polarizing Hardware Kit

MEB-128-P/N 320-9514-003

MEB-184-P/N 320-9514-002

Contains 2 polarizing keys and 4 spiral pins.

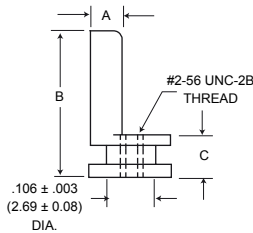
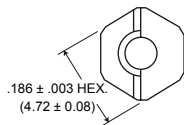

P/N 201-9509-000

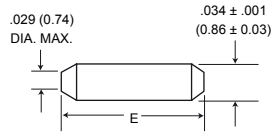

MEB-184
P/N 980-0004-129

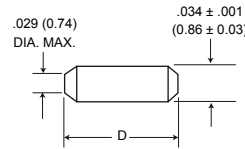

MEB-128
P/N 980-0003-879

Micro Edgeboard - .050" Contact Spacing

MEB

Jackscrew/Jackpost Assembly (MEB 64 & 128 Sizes Only)

Jackpost Kit

MEB plug or receptacle-P/N 320-9514-001
Contains 2 bushings and 4 spirals pins

Jackscrew

MEB plug-P/N 320-9521-001
MEB receptacle-P/N 320-9521-000
Contains 2 jackscrew assemblies

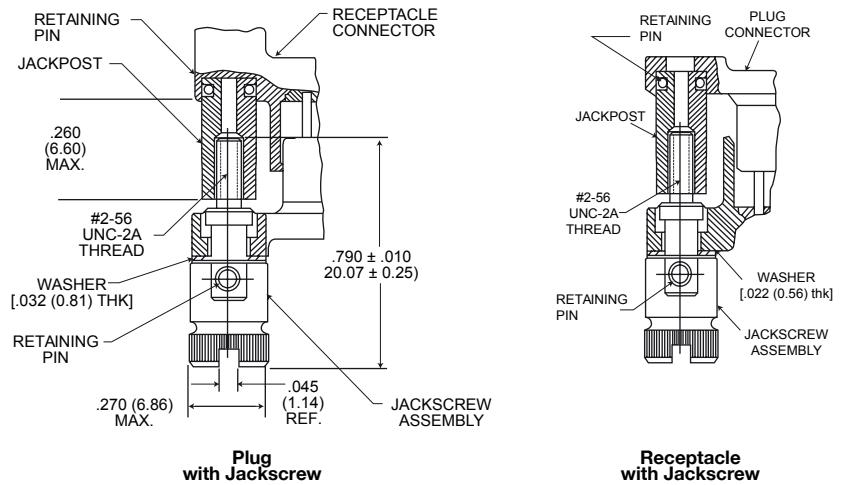

Special Variations

Alternative Receptacle Configuration

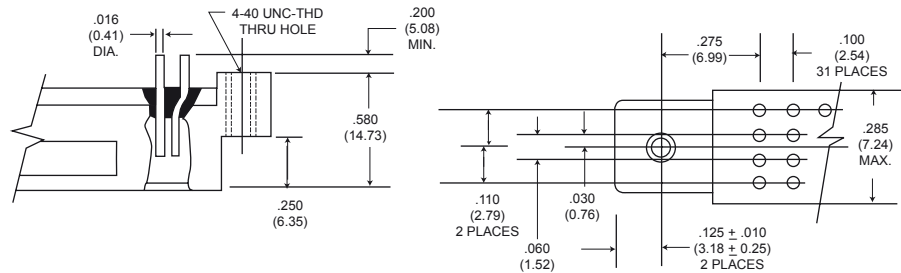

Dimensions shown in mm
Specifications and dimensions subject to change

www.ittcannon.com

Cable Assemblies

Turnkey & Custom Cable Solutions for Cannon Microminiature Connectors

We provide complete turnkey and custom cable assemblies across our expansive portfolio of Microminiature Connectors. Our proven, harsh environment interconnects and cable assemblies are used in the most demanding applications and environments including Aerospace, Defense Electronics, Geophysical Exploration, Oil & Gas, High-Speed Computer Networking, Industrial Automation, Medical Electronics, Satellite and Space Communications and Telecommunications.

Our cable assembly expertise and innovative Six Sigma-driven manufacturing processes enable the design and manufacturing of tight pitch cable assemblies in 0.100, 0.075, 0.050 and 0.025 contact spacing, among many others.

For more details, contact your Cannon Account Representative.

Microminiature Cabling Solutions

- Dynamic Custom Cable Assemblies for Harsh Environments
- Custom Micro-D and MIL-DTL-83513 Interconnect Cable Assemblies
- Space Grade Micro Interconnect Cable Assemblies
- High Temperature Harsh Environment Interconnect Assemblies
- Medical Electronics Cable Assemblies

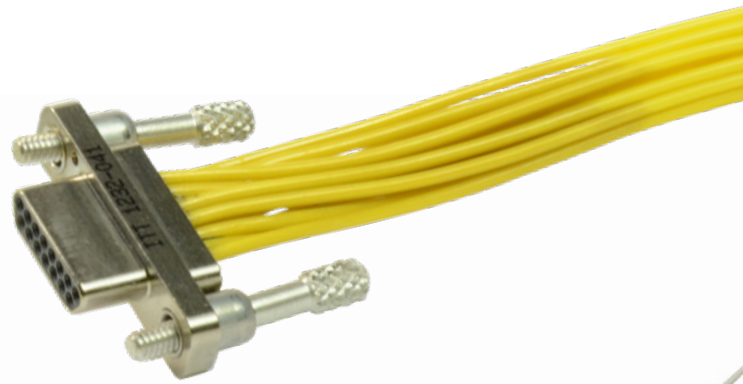

Flex Circuit Cable Assembly

Terminating to Flexible Circuits

For a low profile finish, it is best to terminate flexible circuits in line with the contacts. Since most Microminiature Connectors have contacts set into two or three rows, termination is generally an easy process.

- The diagrams below provide guidance for pad arrangements to suit MDM Microminiature Connectors, ensuring the circuits are inserted into the potting correctly and accurately.
- The length of the pad is optional but it is important to provide enough cover-lay, especially at the edges of the circuit, to avoid delamination. We suggest at least 0,51 mm (.020 inches). Our standard potting shrouds provide support to the circuit with a dimension of 7,00 mm (.275 inches) from the rear of the flange.

Please consult Customer Service for specific flex circuit assembly design considerations and requirements.

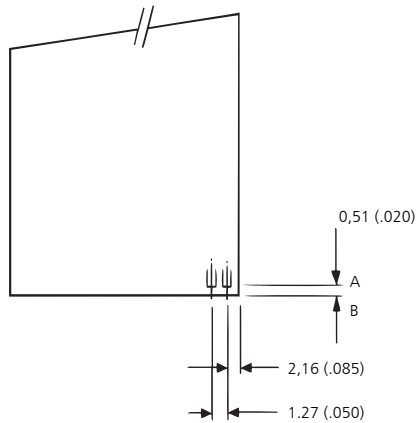
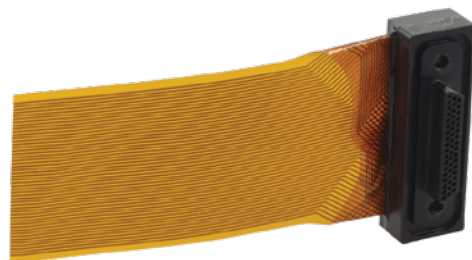
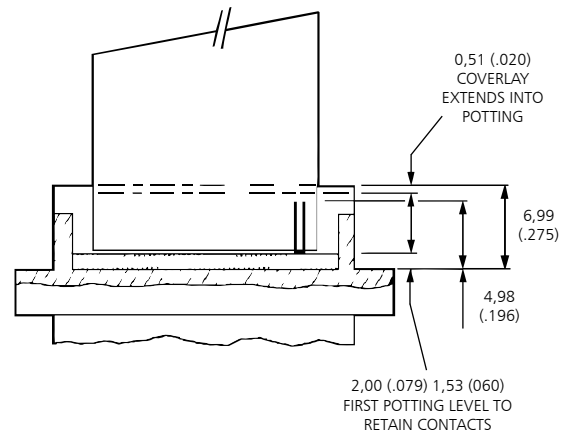

Diagram 1 shows details of the pad spacing and the suggested amount of material to be left between the end of the pad A and the edge of the flex B.

Diagram 2 illustrates how the connector is prepared with short pigtailed and a special first pot which just captures the contacts. The final back potting for strength is controlled by our standard 7,00 (.275) potting fixtures.



Custom Backshells for Microminiature Connectors

ITT Cannon offers a wide range of backshell solutions for Microminiature Connectors used in harsh environment applications. Although we do not offer a standard backshell portfolio, Cannon engineers can design and manufacture a range of back fittings for our MDM Series Microminiature Connectors, depending on customer requirements. We offer custom designs using proven banded systems in which the braid is captivated over a chimney-style outlet. These types of backshell systems are available in different

material finishes and sizes and can be provided with special process termination methods. In addition, ITT Cannon engineers have developed a method of riveting the back fitting to the shell within the jacking area. This option guarantees 360-degree shielding effectiveness even when jackscrews or jacking posts are not being used. When a conduit system is preferred, such as for test box environments in field locations, back fittings and a fully screened weatherproof convoluted trunking can be used. Our

engineering team can also provide special back potting style termination systems for environmental protection and strain relief. These backshell style systems are typically filled with epoxy or other encapsulating materials to provide a robust and effective solution.

Sealing Gaskets

We have received requests for gasket materials to seal the MDM connectors into various enclosures. We recommend that you consider wider flanged connectors together with a low cost conductive gasket to provide an adequate surface area. This combination will give you IP-66 sealing with good EMC compliance. The following dimensions for gaskets and flange dimensions are regarded as the minimum that you should consider.

Conductive elastomers generally offer a superior shielding performance when compared with alternatives as in table below.

| Gasket Type | Neoprene (wire impregnated) | Silicone (wire impregnated) | Silicone (oriented wire) | Neoprene (fabric wrap) | Metallic finger stock | Metallic fibres | Conductive silicone rubber |
|-----------------------|-----------------------------|-----------------------------|--------------------------|------------------------|-----------------------|-----------------|----------------------------|
| Shielding performance | S | S | G | G | G | G | G |
| Temperature range | S | G | G | S | G | G | G |
| IP sealing | P | P | S | S | P | P | G |
| Compression force | G | G | G | G | G | S | S |
| Compression range | S | S | S | G | G | P | S |
| Surface texture | P | P | G | P | G | P | S |
| Compression set | S | S | S | S | G | P | G |
| Re-usability | S | S | S | S | G | P | G |

*Neoprene is a trademark of Dupont P = Poor S = Satisfactory G = Good

Conductive rubber gaskets can be loaded with many different metallic fillers but the choice of material is dependent upon a number of factors such as level of conductivity, shielding effectiveness, galvanic compatibility and cost.

Galvanic Corrosion can occur when two dissimilar metals are in contact with one another in the presence of an electrolyte. The type of gasket material has to be assessed because of the use of metallic fillers. Many applications are dry indoor environments where corrosion is not a major concern. However, for external use, particularly marine, it is recommended that consideration be given to compatibility. The table on the next page is a summary.

| Enclosure Material | Silver/Nickel | Silver/Copper | Silver/aluminum | Inert aluminum | Silver/Glass | Silver | Nickel/Graphit | Nickel |
|--------------------------|---------------|---------------|-----------------|----------------|--------------|--------|----------------|--------|
| Aluminum alloys | X | X | 1 | ▲ | X | X | 1 | 1 |
| Magnesium alloys | X | X | 1 | 1 | X | X | 1 | 1 |
| Stainless steel | ▲ | ▲ | ▲ | ▲ | ▲ | ▲ | ▲ | ▲ |
| Copper alloys | ▲ | ▲ | ▲ | ▲ | ▲ | ▲ | ▲ | ▲ |
| Cadmium plating | X | X | 1 | 1 | X | X | 1 | 1 |
| Tin plating | 1 | X | 1 | | 1 | 1 | ▲ | ▲ |
| Nickel plating | ▲ | 1 | 1 | ▲ | ▲ | ▲ | ▲ | ▲ |
| Chromium plating | ▲ | ▲ | ▲ | ▲ | ▲ | ▲ | ▲ | ▲ |
| Silver plating | ▲ | ▲ | ▲ | ▲ | ▲ | ▲ | ▲ | ▲ |
| Zinc & galvanise plating | X | X | 1 | 1 | X | X | 1 | 1 |
| Titanium | ▲ | ▲ | ▲ | ▲ | ▲ | ▲ | ▲ | ▲ |

▲ = good 1 = Satisfactory X = Not recommended

Appendix

"L" Code Chart

| SORTED BY LENGTH | | |
|------------------|----------|------|
| Wire Length, IN. | | Code |
| Decimal | Fraction | |
| 0.080 | | L63 |
| 0.094 | 3/32 | L62 |
| 0.110 | | L65 |
| 0.125 | 1/8 | L61 |
| 0.140 | | L67 |
| 0.150 | | L56 |
| 0.171 | | L66 |
| 0.187 | 3/16 | L17 |
| 0.190 | | L57 |
| 0.210 | | L59 |
| 0.250 | 1/4 | L39 |
| 0.312 | 3/8 | L60 |
| 0.375 | 3/8 | L58 |
| 0.380 | | L64 |
| 0.500 | 1/2 | L1 |
| 0.625 | 5/8 | L12 |
| 0.750 | 3/4 | L4 |
| 1.000 | | L2 |
| 1.500 | | L7 |
| 2.000 | | L6 |
| 2.250 | | L25 |
| 2.500 | | L16 |
| 3.000 | | L10 |
| 3.500 | | L15 |
| 4.000 | | L11 |
| 4.500 | | L28 |
| 5.000 | | L9 |
| 6.000 | | L3 |
| 7.000 | | L8 |
| 8.000 | | L18 |
| 9.000 | | L45 |
| 10.000 | | L13 |
| 11.500 | | L52 |
| 12.000 | | L4 |
| 15.000 | | L46 |
| 18.000 | | L55 |
| 20.000 | | L5 |

| SORTED BY CODE | | |
|----------------|------------------|----------|
| Code | Wire Length, IN. | |
| | Decimal | Fraction |
| L1 | 0.500 | 1/2 |
| L2 1 | .000 | |
| L3 | 6.000 | |
| L4 | 12.000 | |
| L5 | 20.000 | |
| L6 | 2.000 | |
| L7 | 1.500 | |
| L8 | 7.000 | |
| L9 | 5.000 | |
| L10 | 3.000 | |
| L11 | 4.000 | |
| L12 | 0.625 | 5/8 |
| L13 | 10.000 | |
| L14 | 0.750 | 3/4 |
| L15 | 3.500 | |
| L16 | 2.500 | |
| L17 | 0.187 | 3/16 |
| L18 | 8.000 | |
| L25 | 2.250 | |
| L28 | .500 | |
| L39 | 0.250 | 1/4 |
| L45 | 9.000 | |
| L46 | 15.000 | |
| L52 | 11.500 | |
| L55 | 18.000 | |
| L56 | 0.150 | |
| L57 | 0.190 | |
| L58 | 0.375 | 3/8 |
| L59 | 0.210 | |
| L60 | 0.312 | 5/16 |
| L61 | .0125 | 1/8 |
| L62 | 0.094 | 3/32 |
| L63 | 0.080 | |
| L64 | 0.380 | |
| L65 | 0.110 | |
| L66 | 0.171 | |
| L67 | 0.140 | |

#25AWG, SOLID COPPER WIRE PER QQ-W-343,
TYPE "S", GOLD PLATED PER MIL-G-45204, TYPE
II GRADE C OR D, CLASS 1 (50 MICROINCHES MINIMUM)

Nano "L" Code Charts on page 80.

Dimensions shown in mm
Specifications and dimensions subject to change

www.ittcannon.com

Appendix

"H" Code Charts

16878/4

Wire, Electrical, Polytetrafluorethylene (PTFE) Insulated, 200 Degrees C, 600 Volts, Extruded Insulation

| Length | Yellow | White | System 1 |
|--------|--------|-------|----------|
| 1 | 030 | C30 | A30 |
| 2 | 024 | C24 | A24 |
| 3 | 020 | C20 | 027 |
| 4 | - | C33 | 033 |
| 5 | 031 | C31 | A31 |
| 6 | 019 | 047 | 016 |
| 8 | 026 | C26 | 034 |
| 9 | 015 | C15 | A15 |
| 10 | 029 | C29 | 025 |
| 12 | 028 | 008 | 002 |
| 16 | 039 | C39 | A39 |
| 17 | 036 | C36 | A36 |
| 18 | 001 | 044 | 003 |
| 20 | 038 | C38 | 023 |
| 21 | 055 | C55 | A55 |
| 24 | 009 | 045 | 004 |
| 30 | 010 | C10 | 005 |
| 35 | 018 | C18 | A18 |
| 36 | 011 | 058 | 006 |
| 40 | 037 | C37 | A37 |
| 42 | 012 | 021 | A12 |
| 48 | 013 | C13 | 048 |
| 50 | 040 | C40 | A40 |
| 60 | 014 | C14 | 056 |
| 72 | 017 | 059 | 046 |
| 80 | 032 | C32 | A32 |
| 92 | 022 | C22 | A22 |
| 96 | 035 | C35 | A35 |
| 120 | 042 | C42 | 041 |
| 180 | 043 | C43 | A43 |

22759/11-26

Wire, Electrical, Fluoropolymer-Insulated, Extruded TFE, Silver-Coated Copper Conductor, 600 Volt

| Length | White | 10 Color Repeat | System 1 |
|--------|-------|-----------------|----------|
| 1 | G30 | Y30 | H30 |
| 2 | G24 | Y24 | H24 |
| 3 | G20 | Y20 | H20 |
| 4 | G33 | Y33 | H33 |
| 5 | G31 | Y31 | H31 |
| 6 | 065 | Y19 | 072 |
| 8 | G26 | Y26 | H26 |
| 9 | G15 | Y15 | H15 |
| 10 | G29 | Y29 | H29 |
| 12 | 066 | Y28 | 073 |
| 16 | G39 | Y39 | H39 |
| 17 | G36 | Y36 | H36 |
| 18 | 067 | Y01 | 074 |
| 20 | G38 | Y38 | H38 |
| 21 | G55 | Y55 | H55 |
| 24 | 068 | Y09 | 075 |
| 30 | G10 | Y10 | H10 |
| 35 | G18 | Y18 | H18 |
| 36 | 069 | Y11 | 076 |
| 40 | G37 | Y37 | H37 |
| 42 | G12 | Y12 | H12 |
| 48 | 070 | Y13 | 077 |
| 50 | G40 | Y40 | H40 |
| 60 | G14 | Y14 | H14 |
| 72 | 071 | Y17 | 078 |
| 80 | G32 | Y32 | H32 |
| 92 | G22 | Y22 | H22 |
| 96 | G35 | Y35 | H35 |
| 120 | G42 | Y42 | H42 |
| 180 | G43 | Y43 | H43 |

22759/33-26

Wire, Electrical, Fluoropolymer-Insulated, Crosslinked Modified, ETFE, Lightweight, Silver-Coated, High-Strength Copper Alloy 200 Degrees C, 600 Volt

| Length | White | 10 Color Repeat | System 1 |
|--------|-------|-----------------|----------|
| 1 | V30 | W30 | X30 |
| 2 | V24 | W24 | X24 |
| 3 | V20 | W20 | X20 |
| 4 | V33 | W33 | X33 |
| 5 | V31 | W31 | X31 |
| 6 | V19 | W19 | X19 |
| 8 | V26 | W26 | X26 |
| 9 | V15 | W15 | X15 |
| 10 | V29 | W29 | X29 |
| 12 | V28 | W28 | X28 |
| 16 | V39 | W39 | X39 |
| 17 | V36 | W36 | X36 |
| 18 | V01 | W01 | X01 |
| 20 | V38 | W38 | X38 |
| 21 | V55 | W55 | X55 |
| 24 | V09 | W09 | X09 |
| 30 | V10 | W10 | X10 |
| 35 | V18 | W18 | X18 |
| 36 | V11 | W11 | X11 |
| 40 | V37 | W37 | X37 |
| 42 | V12 | W12 | X12 |
| 48 | V13 | W13 | X13 |
| 50 | V40 | W40 | X40 |
| 60 | V14 | W14 | X14 |
| 72 | V17 | W17 | X17 |
| 80 | V32 | W32 | X32 |
| 92 | V22 | W22 | X22 |
| 96 | V35 | W35 | X35 |
| 120 | V42 | W42 | X42 |
| 180 | V43 | W43 | X43 |

Nano "H" Code Charts on page 82.



Dimensions shown in mm
Specifications and dimensions subject to change

www.ittcannon.com

Appendix

MIL-STD-681 Wire Color Code

Reference Data

| PIN No. | MIL-STD-681 No. | Base Color | First Stripe | Second Stripe | Third Stripe |
|---------|-----------------|------------|--------------|---------------|--------------|
| 1* | 0 | BLK | | | |
| 2* | 1 | BRN | | | |
| 3* | 2 | RED | | | |
| 4* | 3 | ORN | | | |
| 5* | 4 | YEL | | | |
| 6* | 5 | GRN | | | |
| 7* | 6 | BLU | | | |
| 8* | 7 | VIO | | | |
| 9* | 8 | GRY | | | |
| 10* | 9 | WHT | | | |
| 11 | 90 | WHT | BLK | | |
| 12 | 91 | WHT | BRN | | |
| 13 | 92 | WHT | RED | | |
| 14 | 93 | WHT | ORN | | |
| 15 | 94 | WHT | YEL | | |
| 16 | 95 | WHT | GRN | | |
| 17 | 96 | WHT | BLU | | |
| 18 | 97 | WHT | VIO | | |
| 19 | 98 | WHT | GRY | | |
| 20 | 901 | WHT | BLK | BRN | |
| 21 | 902 | WHT | BLK | RED | |
| 22 | 903 | WHT | BLK | ORN | |
| 23 | 904 | WHT | BLK | YEL | |
| 24 | 905 | WHT | BLK | GRN | |
| 25 | 906 | WHT | BLK | BLU | |
| 26 | 907 | WHT | BLK | VIO | |
| 27 | 908 | WHT | BLK | GRY | |
| 28 | 912 | WHT | BRN | RED | |
| 29 | 913 | WHT | BRN | ORN | |
| 30 | 914 | WHT | BRN | YEL | |
| 31 | 915 | WHT | BRN | GRN | |
| 32 | 916 | WHT | BRN | BLU | |
| 33 | 917 | WHT | BRN | VIO | |
| 34 | 918 | WHT | BRN | GRY | |
| 35 | 923 | WHT | RED | ORN | |
| 36 | 924 | WHT | RED | YEL | |
| 37 | 925 | WHT | RED | GRN | |
| 38 | 926 | WHT | RED | BLU | |
| 39 | 927 | WHT | RED | VIO | |
| 40 | 928 | WHT | RED | GRY | |
| 41 | 934 | WHT | ORN | YEL | |
| 42 | 935 | WHT | ORN | GRN | |
| 43 | 936 | WHT | ORN | BLU | |
| 44 | 937 | WHT | ORN | VIO | |
| 45 | 938 | WHT | ORN | GRY | |
| 46 | 945 | WHT | YEL | GRN | |
| 47 | 946 | WHT | YEL | BLU | |
| 48 | 947 | WHT | YEL | VIO | |
| 49 | 948 | WHT | YEL | GRY | |
| 50 | 956 | WHT | GRN | BLU | |

| PIN No. | MIL-STD-681 No. | Base Color | First Stripe | Second Stripe | Third Stripe |
|---------|-----------------|------------|--------------|---------------|--------------|
| 51 | 957 | WHT | GRN | VIO | |
| 52 | 958 | WHT | GRN | GRY | |
| 53 | 967 | WHT | BLU | VIO | |
| 54 | 968 | WHT | BLU | GRY | |
| 55 | 978 | WHT | VIO | GRY | |
| 56 | 9012 | WHT | BLK | BRN | RED |
| 57 | 9013 | WHT | BLK | BRN | ORN |
| 58 | 9014 | WHT | BLK | BRN | YEL |
| 59 | 9015 | WHT | BLK | BRN | GRN |
| 60 | 9016 | WHT | BLK | BRN | BLU |
| 61 | 9017 | WHT | BLK | BRN | VIO |
| 62 | 9018 | WHT | BLK | BRN | GRY |
| 63 | 9023 | WHT | BLK | RED | ORN |
| 64 | 9024 | WHT | BLK | RED | YEL |
| 65 | 9025 | WHT | BLK | RED | GRN |
| 66 | 9026 | WHT | BLK | RED | BLU |
| 67 | 9027 | WHT | BLK | RED | VIO |
| 68 | 9028 | WHT | BLK | RED | GRY |
| 69 | 9034 | WHT | BLK | ORN | YEL |
| 70 | 9035 | WHT | BLK | ORN | GRN |
| 71 | 9036 | WHT | BLK | ORN | BLU |
| 72 | 9037 | WHT | BLK | ORN | VIO |
| 73 | 9038 | WHT | BLK | ORN | GRY |
| 74 | 9045 | WHT | BLK | YEL | GRN |
| 75 | 9046 | WHT | BLK | YEL | BLU |
| 76 | 9047 | WHT | BLK | YEL | VIO |
| 77 | 9048 | WHT | BLK | YEL | GRY |
| 78 | 9056 | WHT | BLK | GRN | BLU |
| 79 | 9057 | WHT | BLK | GRN | VIO |
| 80 | 9058 | WHT | BLK | GRN | GRY |
| 81 | 9067 | WHT | BLK | BLU | VIO |
| 82 | 9068 | WHT | BLK | BLU | GRY |
| 83 | 9078 | WHT | BLK | VIO | GRY |
| 84 | 9123 | WHT | BRN | RED | ORN |
| 85 | 9124 | WHT | BRN | RED | YEL |
| 86 | 9125 | WHT | BRN | RED | GRN |
| 87 | 9126 | WHT | BRN | RED | BLU |
| 88 | 9127 | WHT | BRN | RED | VIO |
| 89 | 9128 | WHT | BRN | RED | GRY |
| 90 | 9134 | WHT | BRN | ORN | YEL |
| 91 | 9135 | WHT | BRN | ORN | GRN |
| 92 | 9136 | WHT | BRN | ORN | BLU |
| 93 | 9137 | WHT | BRN | ORN | VIO |
| 94 | 9138 | WHT | BRN | ORN | GRY |
| 95 | 9145 | WHT | BRN | YEL | GRN |
| 96 | 9146 | WHT | BRN | YEL | BLU |
| 97 | 9147 | WHT | BRN | YEL | VIO |
| 98 | 9148 | WHT | BRN | YEL | GRY |
| 99 | 9156 | WHT | BRN | GRN | BLU |
| 100 | 9157 | WHT | BRN | GRN | VIO |

*10 colors repeat is the standard wire color code for MIL-DTL-83513 connectors.

Dimensions shown in mm
 Specifications and dimensions subject to change

www.ittcannon.com



Micro-D Accessories

Dust Caps

| Arrangement | Anti-Static (Pink) | | Conductive (Black) | |
|-------------|--------------------|--------------|--------------------|--------------|
| | Plug | Receptacle | Plug | Receptacle |
| 9 | 025-9524-000 | 025-9525-000 | 025-9524-003 | 025-9525-003 |
| 15 | 025-9526-000 | 025-9527-000 | 025-9526-003 | 025-9527-003 |
| 21 | 025-9528-000 | 025-9529-000 | 025-9528-003 | 025-9529-003 |
| 25 | 025-9530-000 | 025-9531-000 | 025-9530-004 | 025-9531-003 |
| 31 | 025-9532-000 | 025-9533-000 | 025-9532-003 | 025-9533-003 |
| 37 | 025-9534-000 | 025-9535-000 | 025-9534-003 | 025-9535-003 |
| 51 | 025-0936-000 | 025-9537-000 | 025-9536-004 | 025-9537-003 |
| 100 | 025-9553-000 | 025-9554-000 | 025-9553-003 | 025-9554-002 |

About ITT Cannon

ITT is a diversified leading manufacturer of highly engineered critical components and customized technology solutions for the energy, transportation and industrial markets. Building on its heritage of innovation, ITT partners with its customers to deliver enduring solutions to the key industries that underpin our modern way of life. Founded in 1920, ITT is headquartered in White Plains, N.Y., with employees in more than 35 countries and sales in a total of approximately 125 countries. For more information visit itt.com

ITT's Cannon brand offers a product portfolio that remains one of the most extensive in the industry. Continuous investment in technology, research and investment have enabled us to provide new, innovative solutions to markets including:

- Commercial Aerospace
- Military & Defense
- Industrial
- Transportation
- Medical

When you specify an ITT Cannon interconnect solution, you can rely on products designed, developed and manufactured to the highest quality and reliability standards. This tradition of excellence is based on ITT Cannon's corporate culture of operating its businesses under the principles of Six Sigma. At ITT, Six Sigma is not just a quality philosophy but a complete corporate culture that drives the entire business. Our Value Based Management and Value-Based Product Development systems are two cornerstones that allow for the development of both leadership and product engineering principles.

Six Sigma Manufacturing

ITT Cannon operates manufacturing facilities in the United States, Germany, Italy, Mexico, China and Japan, all of which have particular product area strengths that allow ITT Cannon to offer a truly global presence to our customers. Our facilities are world class and accommodate full vertical integration, utilizing the latest manufacturing technologies including automated and robotic machining centers, Super Market manufacturing cells, Kanban pull systems, and automated electrical, mechanical, and optical test and inspection equipment. The combination of our manufacturing strength and our advanced manufacturing facilities allows ITT Cannon to offer products at market driven prices. Our capabilities, especially in robotics, computerized precision tooling, Kaizen Project Management, Six Sigma tools and testing give ITT the most optimized global manufacturing footprint in the interconnect industry.

The Custom Difference

As an industry leader in harsh environment interconnect applications, ITT Cannon's world class engineering teams work directly with our customers to design and develop cost-effective solutions for their applications. In many cases we may modify one of our standard designs to ensure a highly reliable solution where timing is critical. When custom connectors are required, we collaborate with clients and partners with a goal to design the most reliable, cost-effective solution possible. Our engineering and product management teams provide a thorough analysis of proposed solutions, ensuring our customers receive the right solution for their program and application needs.

RoHS Compliance Information

ITT Cannon has implemented a strict parts control plan for all ITT Cannon electronics plants worldwide that allows the Cannon product portfolio to meet the requirements of the European Union Directive 2002/95/EC better known as the Reduction of Hazardous Substances initiative. As appropriate, specific Cannon products may be ordered with an R prefix number which insures our customers will receive RoHS compliant parts for their commercial electronics applications and equipment. Since most RoHS hazardous substances center around specific metal plating and lead solder coatings, ITT Cannon's products for RoHS compliance are available in the following plating finishes: electroless nickel, stainless steel, anodize over aluminum and gold plating. It should be noted that gold plating would be recommended as the replacement for tin-lead solder when ordering board mount connectors.



Product Safety Information

This note must be read in conjunction with the product data sheet/catalog. Failure to observe the advice in this information sheet and the operating conditions specified in the product data sheet/ catalog could result in hazardous situations.

1. MATERIAL CONTENT AND PHYSICAL FORM

(a) Electrical connectors do not usually contain hazardous materials. They contain conducting and non-conducting materials and can be divided into two groups: Printed circuit types and low cost audio types which employ all plastic insulators and casings.

(b) Rugged, Fire Barrier and High Reliability types with metal casings and either natural rubber, synthetic rubber, plastic or glass insulating materials. Contact materials vary with type of connector and also application and are usually manufactured from either: Copper, copper alloys, nickel, alumel, chromel or steel. In special applications, other alloys may be specified.

2. FIRE CHARACTERISTICS AND ELECTRIC SHOCK HAZARD

There is no fire hazard when the connector is correctly wired and used within the specified parameters. Incorrect wiring or assembly of the connector or careless use of metal tools or conductive fluids, or transit damage to any of the component parts may cause electric shock or burns. Live circuits must not be broken by separating mated connectors as this may cause arcing, ionization and burning. Heat dissipation is greater at maximum resistance in a circuit. Hot spots may occur when resistance is raised locally by damage, e.g. cracked or deformed contacts, broken strands of wire. Local over-heating may also result from the use of the incorrect application tools or from poor quality soldering or slack screw terminals. Overheating may occur if the ratings in the product Data Sheet/Catalog are exceeded and can cause breakdown of insulation and hence electric shock. If heating is allowed to continue it intensifies by further increasing the local resistance through loss of temper of spring contacts, formation of oxide film on contacts and wires and leakage currents through carbonization of insulation and tracking paths. Fire can then result in the presence of combustible materials and this may release noxious fumes. Overheating may not be visually apparent. Burns may result from touching overheated components.

3. HANDLING

Care must be taken to avoid damage to any component parts of electrical connectors during installation and use. Although there are normally no sharp edges, care must be taken when handling certain components to avoid injury to fingers. Electrical connectors may be damaged in transit to the customers, and damage may result in creation of hazards. Products should therefore be examined prior to installation/use and rejected if found to be damaged.

4. DISPOSAL

Incineration of certain materials may release noxious or even toxic fumes.

5. APPLICATION

Connectors with exposed contacts should not be selected for use on the current supply side of an electrical circuit, because an electric shock could result from touching exposed contacts on an unmated connector. Voltages in excess of 30 V ac or 42.5 V dc are potentially hazardous and care should be taken to ensure that such voltages cannot be transmitted in any way to exposed metal parts of the connector body. The connector and wiring should be checked, before making live, to have no damage to metal parts or insulators, no solder blobs, loose strands, conducting lubricants, swarf or any other undesired conducting particles. Circuit resistance and continuity check should be made to make certain that there are no high resistance joints or spurious conducting paths. Always use the correct application tools as specified in the Data Sheet/Catalog. Do not permit untrained personnel to wire, assemble or tamper with connectors. For operation voltage please see appropriate national regulations.

IMPORTANT GENERAL INFORMATION

(i) Air and creepage paths/operating voltage. The admissible operating voltages depend on the individual applications and the valid national and other applicable safety regulations.

For this reason the air and creepage path data are only reference values. Observe reduction of air and creepage paths due to PC board and/or harnessing.

(ii) Temperature. All information given are temperature limits. The operation temperature depends on the individual application.

(iii) Other important information. Cannon continuously endeavors to improve their products. Therefore, Cannon products may deviate from the description, technical data and shape as shown in this catalog and data sheets.

ITT Cannon is a business unit of ITT Cannon Inc., which manufactures the highest quality products available in the marketplace; however these products are intended to be used in accordance with the specifications in this publication. Any use or application that deviates from the stated operating specifications is not recommended and may be unsafe. No information and data contained in this publication shall be construed to create any liability on the part of Cannon. Any new issue of this publication shall automatically invalidate and supersede any and all previous issues

All data subject to change without notice.

We connect when it matters most

Meet some of Cannon's most popular, reliable and proven interconnect solutions

KPT Series I Miniature Circular Connector

Cannon's KPT Series I Mini-Circular is a robust, general-purpose interconnect used for a wide range of markets and applications including Ground Vehicles, Industrial Equipment, IFE/C and Military Aviation. It has a positive three-point bayonet coupling, five-key way polarization and high insert arrangement contact density. These rugged connectors are also available in a variety of plating options.



D-Subminiature Connectors

Originally designed for aircraft radio systems, Cannon's D-Subminiature Connector became the first multi-purpose interconnect solution of its kind, ideal for multiple markets and applications. From rocket launchers and satellite systems, to rugged military transports and commercial avionics, the D-Subminiature's versatility has made this Cannon invention the most widely used connector in the world.



Quadrax

Our family of innovative Quadrax contacts is based on the ARINC 600 physical interface, with a highly engineered design to facilitate deployment of Ethernet LAN's in Land, Sea or Air installations using ARINC 600, ARINC 404 or 38999-style connectors. The Quadrax contact enables high-speed data transfer rates up to 2.5 Gbs and features rear release crimp pin and socket Quadrax Contacts, as well as front release PC pin Quadrax contacts. It is available in a variety of 38999-style layout arrangement in the following shell styles: wall mount receptacle, box mount receptacle and jam nut receptacle and straight plug.



cannon

Amazing things
happen when great
things connect

The background is a solid red color. In the bottom right corner, there is a large, abstract graphic consisting of several curved, overlapping lines. These lines are primarily in shades of blue and cyan, with some sections in orange and yellow, creating a sense of motion and depth. The lines curve upwards and to the right, partially overlapping the red background.

Connect with your ITT Cannon representative today
or visit us at www.ittcannon.com

Connect with the experts

We deliver high performance, harsh environment interconnect solutions that enable the transfer of data, signal and power in an increasingly connected world.

Why ITT

ITT Cannon is a focused, multi-industrial company that designs and manufactures highly engineered critical components and customized technology solutions. ITT Cannon is a leading global manufacturer of connector products serving international customers in the aerospace and defense, industrial and medical end markets. We design and engineer a variety of interconnect solutions that make it possible to transfer data, signal and power in an increasingly connected world.

Connect with your ITT Cannon representative today or visit www.ittcannon.com

| | | | | | |
|---|--|---|--|--|--|
| CHINA—Shenzhen City +86.755.2726.7888 | GERMANY—Weinstadt +49.7151.699.0 | INDIA—Bangalore +91 22 67843000 | JAPAN—Kanagawa +81.462.57.2010 | SINGAPORE +65 66974205 | USA—Irvine, CA +1.800.854.3028 |
| FRANCE +33.1.60.04.93.93 | HONG KONG +852.2732.2720 | ITALY—Lainate +39.02938721 | MEXICO—Nogales +52.631.311005 | UK—Basingstoke +44.1256.347400 | |