

■ 外形寸法(mm) / Dimensions (mm)

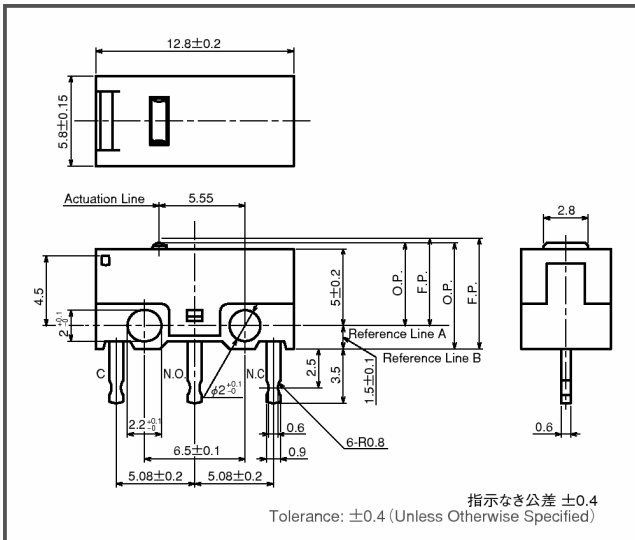

■ 安全規格 / Agency Approvals

シリーズ名	DG1	DG2	DG4
UL	適用規格	UL1054	
	File No.	E300187	

【特長】 [Features]

- 極超小型
- 銀合金+金メッキ接点
- 標準、軽作動の2種類の動作力
- Ultra compact size (12.8×5.8×6.5mm)
- Insert molding terminals: PC board mounting

■ 取得規格 / Agency Approved



✓RoHS対応品

■ 定格 / Rating

DG1	UL, CUL	3A, 125VAC 2A, 30VDC
DG2	UL, CUL	50mA, 30VDC
DG4	UL, CUL	1A, 125VAC 1A, 30VDC
DG6	安全規格認定なし Non Approved	3A, 125VAC 2A, 30VDC

■ 性能 / Performance

回路構成 Circuitry	単極双投 S. P. D. T.	
耐熱性 Heat Resistance	UL94V-0	
接触抵抗 Contact Resistance	50mΩ以下 50mΩ MAX	
機械的寿命 Mechanical Life	DG1	1,000,000回以上 / 1,000,000 Cycles MIN
	DG2	1,000,000回以上 / 1,000,000 Cycles MIN
	DG4	1,000,000回以上 / 1,000,000 Cycles MIN
	DG6	1,000,000回以上 / 1,000,000 Cycles MIN
電氣的寿命 Electrical Life	DG1 (AC定格)	10,000回以上 / 10,000 Cycles MIN
	DG1 (DC定格)	30,000回以上 / 30,000 Cycles MIN
	DG2 (DC定格)	200,000回以上 / 200,000 Cycles MIN
	DG4 (AC定格)	10,000回以上 / 10,000 Cycles MIN
	DG4 (DC定格)	10,000回以上 / 10,000 Cycles MIN
	DG6 (AC定格)	10,000回以上 / 10,000 Cycles MIN
安全規格上の電氣的寿命 Agency Approved Life	6,000回 (DG1, DG2, DG4のみ)	
使用温湿度範囲 Temperature Rating Range	-25 ~ +85°C 85%RH以下 (ただし結露なきこと) -25 ~ +85°C 85%RH Below (Non Condensation)	
絶縁抵抗 Insulation Resistance	端子相互間: 100MΩ以上 (DC500V) Between terminals: 100MΩ Min (DC500V) 対アース間: 100MΩ以上 (DC500V) Between terminals and grounded parts: 100MΩ Min (DC500V)	
耐電圧 Dielectric Strength	端子相互間: AC1000V 1分間 Between terminals: AC1000V 1 minute 対アース間: AC1500V 1分間 Between terminals and grounded parts: AC1500V 1 minute	
耐振性 Vibration Proof	10~55Hz 全振幅1.5mm 10~55Hz Peak to peak amplitude 1.5mm	
耐衝撃性 Shock Proof	294m/s ² (30G)	
最小使用電流電圧範囲 Minimum Currnt Voltage Range	DG1	0.05A, 5VDC または0.01A, 12VDC
	DG2	1mA, 5VDC
	DG4	1mA, 5VDC
	DG6	1mA, 5VDC

■ 材質 / Material

(難燃性 / Flame-Retardant)

ベース Base	PPS樹脂、DG6のみPBT樹脂 PPS, PBT (DG6)	UL94V-0
カバー Cover	PBT樹脂 PBT	UL94V-0
ボタン Button	PBT樹脂 PBT	UL94V-0
ブレード Blade	ベリリウム銅 Beryllium copper	
端子 Terminal	黄銅(銀メッキ) Brass (Silver plated)	
接点 Contact	銀合金 + 金メッキ Silver alloy + Gold plated	
アクチュエータ Actuator	ステンレス POM樹脂(ローラー) Stainless steel POM (Roller)	

DG シリーズ DG Series

■ 品名構成表 / Ordering Information

DG 1 3 - B 1 A A

コード Code	定格 Rating
1	3A, 125VAC 2A, 30VDC
2	0.05A, 30VDC
4	1A, 125VAC 1A, 30VDC
6	3A, 125V AC 2A, 30V DC 安全規格認定なし Non approved.

コード Code	回路構成 Circuitry
1	N.O
2	N.C
3	N.O/N.C

コード Code	動作力 OF
B	標準 / Standard
C	軽作動 / Light

コード Code	端子形状 Terminal Configuration
1	PCB
2	PCBライト / PCB Right
3	PCBレフト / PCB Left

コード Code	コード Code	アクチュエータ長 Auxiliary Actuator-length			
ボタン Button	A	A	B	C	D
レバー Lever	L	4.35	12.7	25.7	
ローラー Roller	R	1.4			

アクチュエータ長
Actuator-length

動作位置
at Operating Point

■ 端子形状図 / Terminals

PCB

PCBライト / PCB Right

PCBレフト / PCB Left

指示なき公差 ±0.4
Tolerance: ±0.4 (Unless Otherwise Specified)

■ 取付穴寸法図 / PCB Footprint

・プリント基板加工寸法 / PCB Foot print

・取り付け穴加工寸法 / Mounting hole

■ 適用電流電圧範囲 / Current Voltage Range

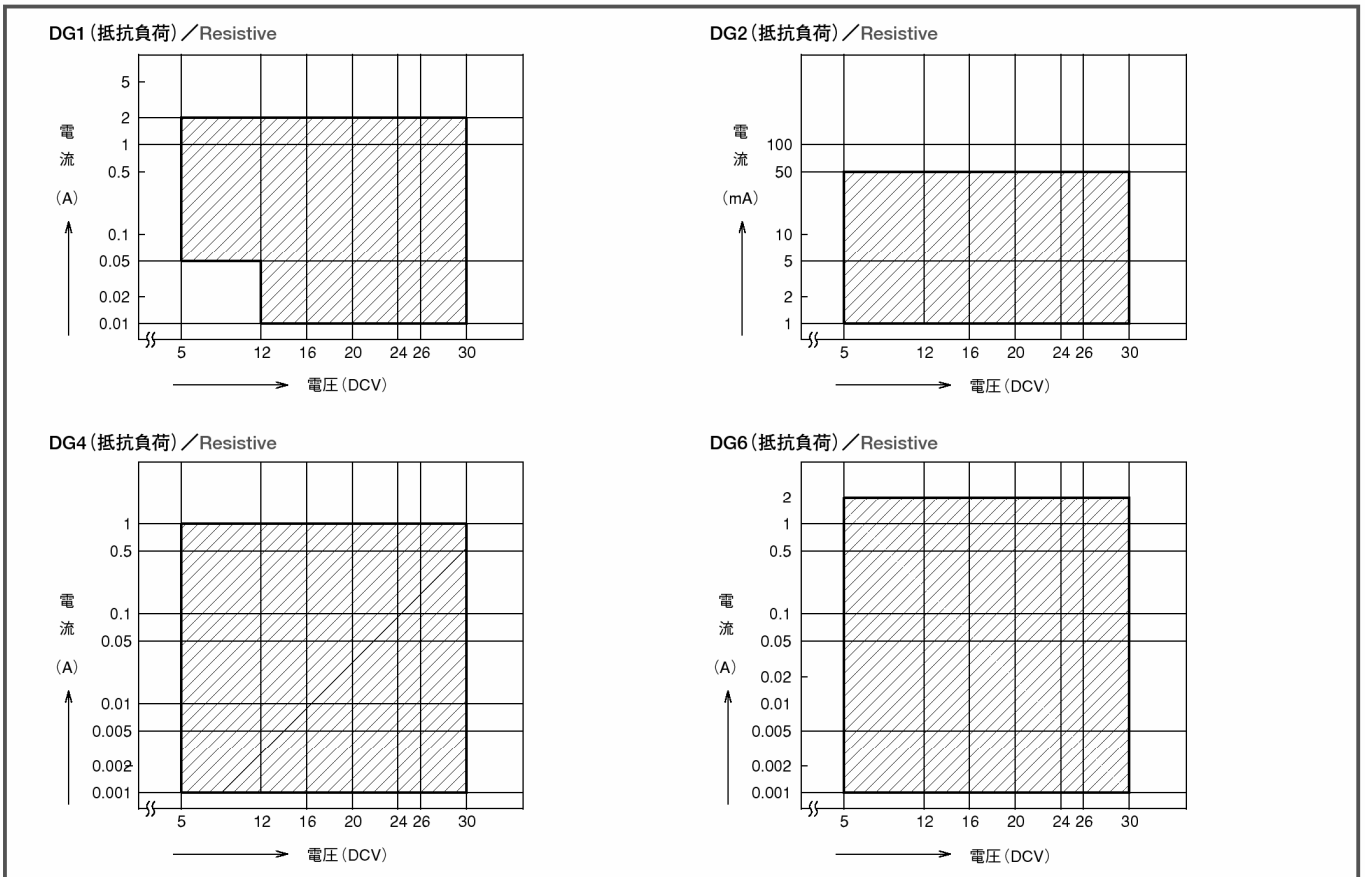



動作特性 / Operating Characteristics

	OF	PT	OP※	OT	MD	FP※
DG□□-B□AA	137cN Max.	0.5mm Max.	5.4 ±0.2mm	0.2mm Min.	0.1mm Max.	5.7 ±0.2mm
DG□□-B□LA	44.1cN Max.	1.8mm Max.	6.8 +0.8/-0.4mm	0.55mm Min.	0.5mm Max.	8 +1.4/-0.7mm
DG□□-B□RA	58.98cN Max.	1.5mm Max.	12.4 ±0.5mm	0.55mm Min.	0.5mm Max.	13.4 ±0.5mm
DG□□-C□AA	73.5cN Max.	0.5mm Max.	5.4 ±0.2mm	0.2mm Min.	0.1mm Max.	5.7 ±0.2mm
DG□□-C□LA	29.4cN Max.	1.8mm Max.	6.8 +0.8/-0.4mm	0.55mm Min.	0.5mm Max.	8 +1.4/-0.7mm
DG□□-C□RA	34.3cN Max.	1.5mm Max.	12.4 ±0.5mm	0.55mm Min.	0.5mm Max.	13.4 ±0.5mm

注1、※印はReference Line (A) からの距離 / Distance from Reference Line (A)

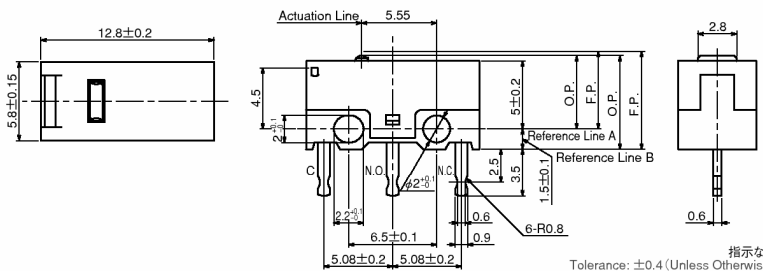
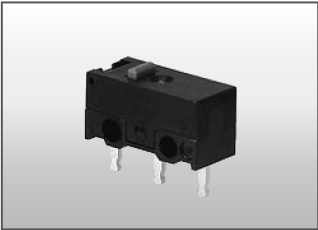
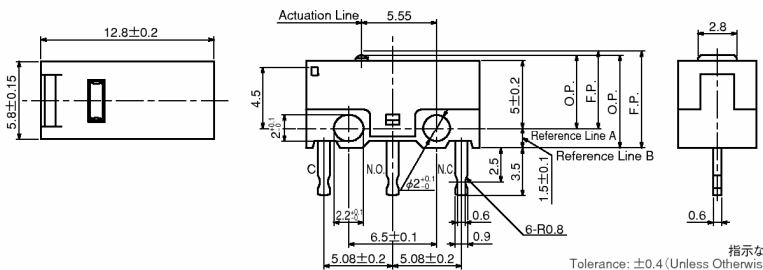
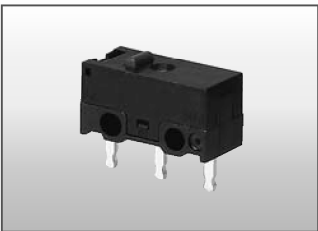
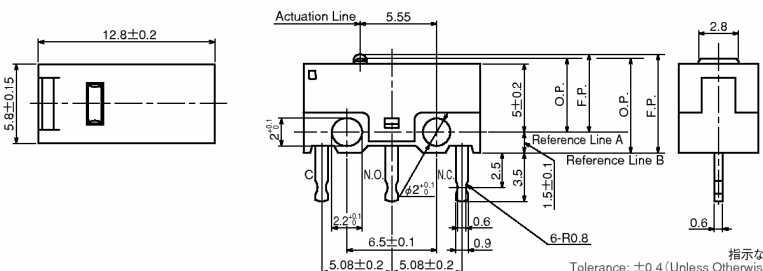
外形寸法 (mm) / Dimensions (mm)

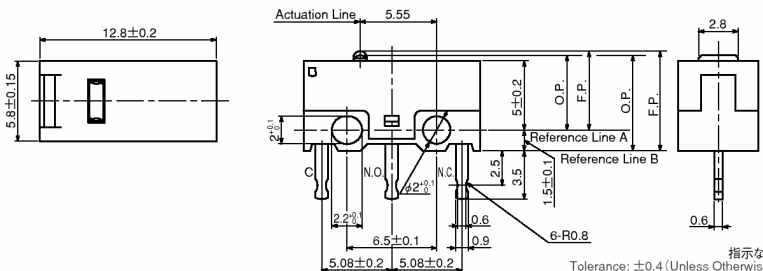
形名及び型番 Type	寸法図 Dimensions
DG23-B1AA 	 <p>指示なき公差 ±0.4 Tolerance: ±0.4 (Unless Otherwise Specified)</p>
DG13-B1AA 	 <p>指示なき公差 ±0.4 Tolerance: ±0.4 (Unless Otherwise Specified)</p>
DG43-C1AA 	 <p>指示なき公差 ±0.4 Tolerance: ±0.4 (Unless Otherwise Specified)</p>
DG23-C1AA 	 <p>指示なき公差 ±0.4 Tolerance: ±0.4 (Unless Otherwise Specified)</p>

DG シリーズ

DG Series

■ 外形寸法 (mm) / Dimensions (mm)

形名及び型番号
Type

DG11-B1RA

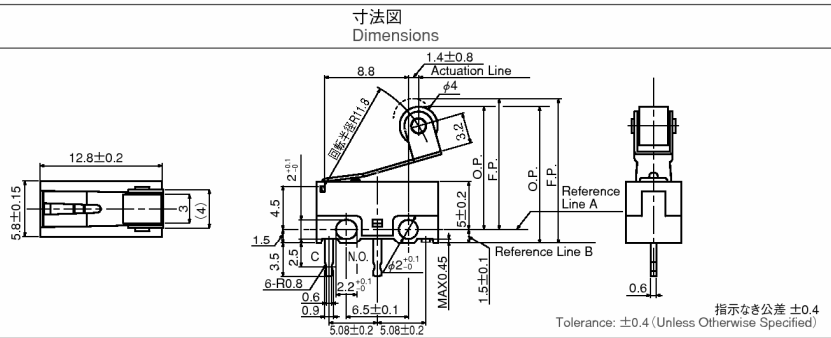

DG12-B1RA

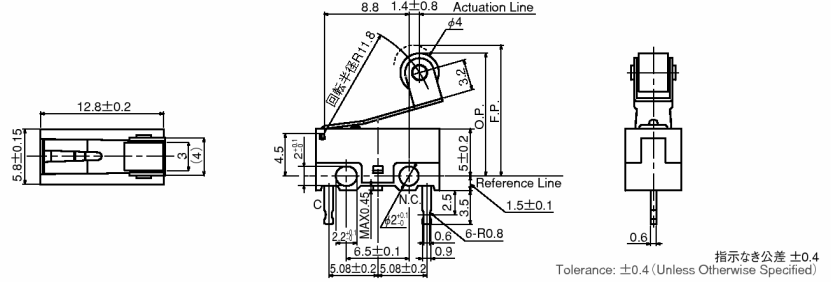

DG43-C1RA

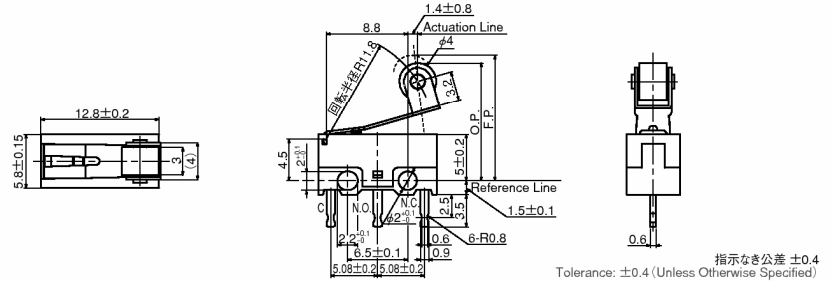
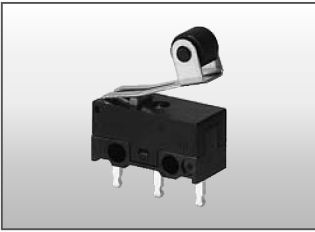

DG23-B1LC

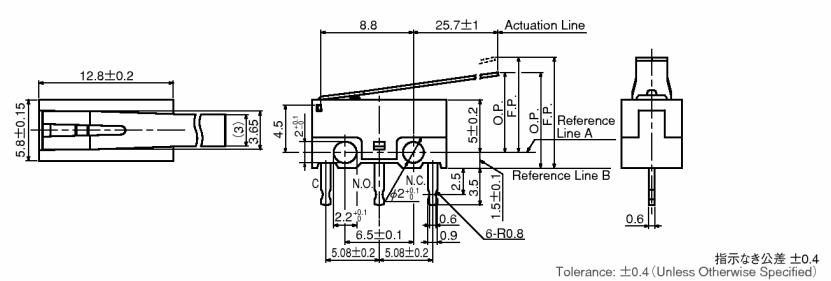
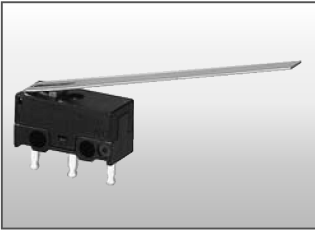

DG13-B2RA

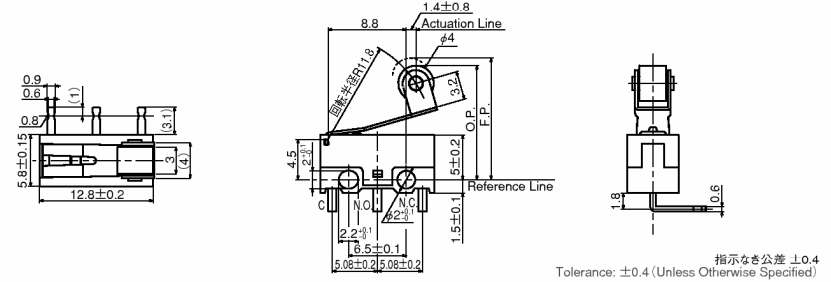

DG13-B3RA

