



Features

- 2" x 4" x 1.3" Package
- Suitable for 1U Applications
- 110W w/air, 80W convection cooled
- Universal Input 90-264Vac
- Efficiency 87% typical
- Approved to CSA/EN/IEC/UL60950-1, 2nd Edition
- Power Fail Signal
- Remote Sense
- 3 Year Warranty
- RoHS Compliant



Description

The CINT3110 Series are industrial grade, high efficiency, triple output power supplies in a small 2" x 4" size. The CINT3110 family is ideal for Industrial and ITE applications requiring multiple outputs and small footprint. Compliant to IEC60950-1 2nd edition, the CINT3110 models feature outputs of 5/±12V, 5/±15V, 5/±24V, includes a Power Fail/DC OK signal, and meet Class B Conducted EMI.

Model Selection

Model Number	Volts*		Output Current**		Ripple & Noise***	Total Regulation	OVP Threshold
			w/200LFM air	Convection			
CINT3110A0508K01	V1	5V	14.0A	10.0A	1.0% pk-pk	±2%	7.5V max.
	V2	12V	6.0A	4.5A	1.0% pk-pk	±3%	115%-135%
	V3	-12V	1.0A	1.0A	2.0% pk-pk	±10%	115%-135%
CINT3110A1708K01	V1	5V	14.0A	10.0A	1.0% pk-pk	±2%	7.5V max.
	V2	15V	4.5A	3.5A	1.0% pk-pk	±3%	115%-135%
	V3	-15V	1.0A	1.0A	2.0% pk-pk	±10%	115%-135%
CINT3110A1908K01	V1	5V	12.0A	8.0A	1.0% pk-pk	±2%	7.5V max.
	V2	24V	4.0A	3.0A	1.0% pk-pk	±3%	115%-135%
	V3	-24V	1.0A	1.0A	2.0% pk-pk	±10%	115%-135%

Notes: * 5V output is adjustable with +/-10% range

** Total convection power is 80 Watts.

*** Measured with noise probe directly across output terminals, and load terminated with 0.1µF ceramic and 10µF low ESR capacitors. Ripple & Noise of V2 at no load is 2% maximum.

General Specifications

AC Input	100-240Vac, ±10%, 47-63Hz, 1Ø 120-370Vdc	Turn On Time	Less than 2 sec. @115Vac (inversely proportional to input voltage and thermistor temperature)
Input Current	115Vac: 1.5A, 230Vac: 0.75A	Hold-up Time	16mS typical at 110W, 120Vac input

General Specifications (continued)

Inrush Current	264Vac, cold start: will not exceed 45A	Signals	AC Power Fail, DC OK
Input Fuses	F1, F2: 2.5A, 250Vac fuses provided on all models	Overload Protection	150%-300% above rating for V2 & V3, 110%-200% for V1. Hiccup Mode
Earth Leakage Current	<290 μ A@264Vac, 60Hz, NC	Short Circuit Protection	Provided - no damage will occur if the output is shorted.
Efficiency	87% typical at 230Vac	Overvoltage Protection	See models chart for trip range.
Output Power	110W continuous with 200 lfm airflow, 80W convection cooled – See chart for specific voltage model ratings.	Switching Frequency	PFC: 75kHz typical
Transient Response	500 μ S typ. for return to within 0.5% of nominal, 50% load step. $\Delta i/\Delta t < 0.2A/\mu S$. Max Volt Deviation = 3%	Isolation	Input-Output: 4000Vac Input-Ground: 1800Vac Output-Ground: 500Vac
Ripple and Noise	See models chart	Operating Temperature	-10°C to +70°C
Output Voltage	See models chart	Temperature Derating	Derate output power linearly above 50°C to 50% at 70°C
Voltage Adjustability	+/-10% from nominal on 5V output	Storage Temperature	-40°C to +85°C
Minimum Load	Not required	Altitude	Operating: -500 to 10,000 ft. Non-operating: -500 to 40,000 ft.
Total Regulation	See models chart	Relative Humidity	5% to 95%, non-condensing
Vibration	Operating: 0.003g ² /Hz, 1.5grms overall, 3 axes, 10 min/axis Non-Operating: 0.026g ² /Hz, 5.0grms overall, 3 axes, 1 hr/axis	Shock	Operating: Half-sine, 20gpk, 10ms, 3 axes, 6 shocks total Non-Operating: Half-sine, 40 gpk, 10 ms, 3 axes, 6 shocks total
Dimensions	W: 2.0" x L: 4.0" x H: 1.3"	Safety Standards	EN/CSA/UL/IEC 60950-1, 2 nd Edition
Weight	200g	MTBF	245,000 hours, 25°C Ambient, 110Vac input

Auxiliary Signals

AC Power Fail:	During normal operation, stays HIGH. Signal goes LOW with at least 6mS warning before loss of DC output from AC failure.	DC OK:	Open collector logic signal goes and stays HIGH 100mS to 500mS after main output reaches regulation.
Remote Sense:	(5V output, optional) Will compensate for 0.5V drop min. Will operate without remote sense connected. Reverse connection protected.		

Notes:

- Specifications are for convection rating at factory settings at 115 Vac input, 25°C ambient unless otherwise stated.
- For DC input an external DC safety rated fuse must be used.

EMI/EMC Compliance

Conducted Emissions	EN55011/22 Class B, FCC Part 15, Subpart B, Class B
Radiated Emissions	EN55011/22 Class A; FCC Part 15, Subpart A, Class A
Static Discharge Immunity	EN61000-4-2, Criteria A, 6kV Contact Discharge, 8kV air discharge
Radiated RF Immunity	EN61000-4-3, 3V/m. Criteria A
EFT/Burst Immunity	EN61000-4-4, 2kV/5kHz, Criteria A
Line Surge Immunity	EN61000-4-5, 1kV differential, 2kV common-mode, Criteria A
Conducted RF Immunity	EN61000-4-6, 3Vrms, Criteria A
Power Frequency Magnetic Field Immunity	EN61000-4-8, 3A/m, Criteria A
Voltage Dip Immunity	EN61000-4-11, 0% Vin, 0.5cycle; 40% Vin, 5 cycles; 70% Vin, 25 cycles; Criteria A
Line Harmonic Emissions	EN61000-3-2, Class A, B, C, & D
Flicker Test	EN61000-3-3, Complies (dmax<6%)

Mechanical Drawing

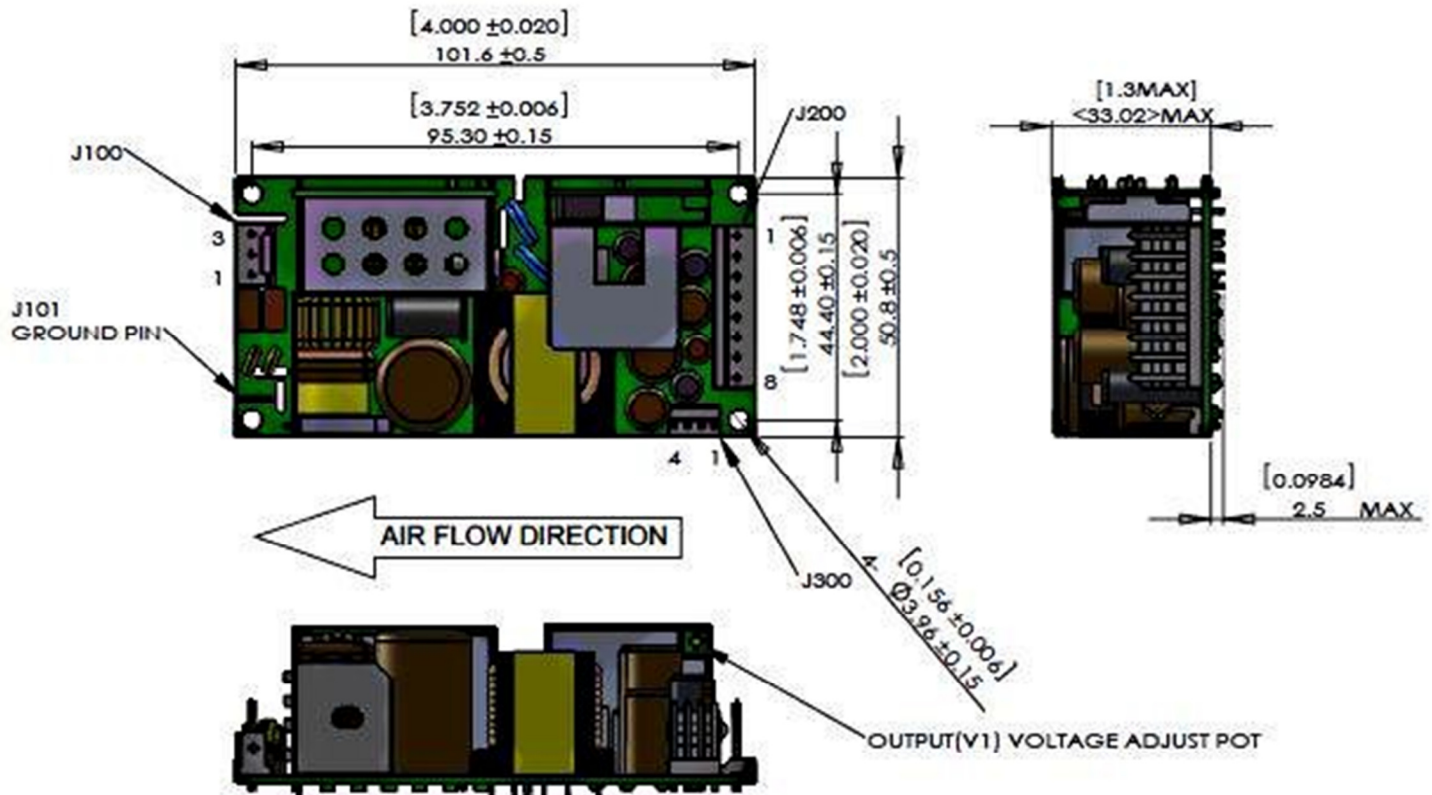

Notes:

1. All dimensions in inches (mm), tolerance is ± 0.02 ".
2. Mounting holes should be grounded for EMI purpose
3. Mounting J101 is safety ground connection
4. This power supply requires mounting on metal standoffs 0.20" (5 m) in height.

Connector Information

Input Connector J100	Ground J101	DC Output Connector J200			Signal Connector J300
PIN 1) AC NEUTRAL PIN 2) EMPTY PIN 3) AC LINE	0.187" FASTON TAB	PIN 1) +V1 PIN 2) +V1 PIN 3) GND	PIN 4) GND PIN 5) GND PIN 6) GND	PIN 7) V2 PIN 8) V3	PIN 1) Power Fail/DC OK PIN 2) GND PIN 3) +Remote Sense PIN 4) -Remote Sense
Mating Connector: Molex 09-50-3031 Pins= 08-52-0072 AMP #640250-3 Pins= 3-640706-1	Mating Connector: Molex 01-90020001	Mating Connector: Amp #640250-8 Pins=Amp #3-640706-1			Mating Connector: Amp #1375820-4 Pin= Amp #1375819

Isolation Specifications

Parameter	Conditions/Description	Min	Nom	Max	Units
Insulation Safety Rating	Input/Ground Input/Output Output/Ground		Basic Reinforced Operational		
Electric Strength Test Voltage	Input/Ground Input/Output Output/Ground	1800 4000 500	-	-	Vac Vac Vac

Leakage Current

Parameter	Conditions/Description	Max
Earth Leakage Current	Normal Condition (NC) Single Fault Condition (SFC)	290µA 420µA
Touch Current	Normal Condition (NC) Single Fault Condition (SFC)	90µA 170µA

Input Specifications

All specifications apply over specified input voltage, output load, and temperature range, unless otherwise noted.

Parameter	Conditions/Description	Min	Nom	Max	Units
Input Voltage		90	115/230	264	Vac
Input Frequency		47	50/60	63	Hz
Input Current	115Vac/max load			1.5	A
Input Current	230Vac/max load			0.75	A
Inrush Current	264Vac, cold start, 25°C	-	-	45	A
Efficiency	$V_{I\ nom}, I_{O\ nom}$ CINT3110A0508K01 CINT3110A1708K01 CINT3110A1908K01	-	87%	-	%

Output Specifications

Parameter	Conditions/Description	Min	Nom	Max	Units
Output Current V1 Output Current V2 Output Current V3	CINT3110A0508K01	0 0 0	10.0 4.5 1	14.0 6.0 1	ADC
Output Current V1 Output Current V2 Output Current V3	CINT3110A1708K01	0 0 0	10.0 3.5 1	14.0 4.5 1	ADC
Output Current V1 Output Current V2 Output Current V3	CINT3110A1908K01	0 0 0	8.0 3.0 1	12.0 4.0 1	ADC

Output Specifications (continued)

Parameter	Conditions/Description	Min	Nom	Max	Units
Static Line Regulation V1	V_i min- V_i max, V_i nom, 0-100% I_{o1} max	-2	-	2	% V_o nom
Static Line Regulation V2	V_i min- V_i max, V_i nom, 0-100% I_{o2} max	-3	-	3	% V_o nom
Static Line Regulation V3	V_i min- V_i max, V_i nom, 0-100% I_{o3} max	-10	-	10	% V_o nom
Static Load Regulation V1 (Droop Characteristic)	V_i min- V_i max, V_i nom, 0-100% I_{o1} max	-2	-	2	% V_o nom
Static Load Regulation V2 (Droop Characteristic)	V_i min- V_i max, V_i nom, 0-100% I_{o2} max	-3	-	3	% V_o nom
Static Load Regulation V3 (Droop Characteristic)	V_i min- V_i max, V_i nom, 0-100% I_{o3} max	-10	-	10	% V_o nom
Hold-Up Time	$V_{in} = 120V_{ac}$, $P_o = 110W$	16	-	-	mS
Dynamic Load Regulation V1, V2, V3	Load change =50%, $di/dt = 0.2A/\mu S$	0	-	3	% V_o nom
Start-Up Time	$V_{in} = 115V_{ac}$, I_o nom	0	-	2	S
Ripple & Noise V1	20MHz bandwidth	0	-	1%	% V_o nom
Ripple & Noise V2	20MHz bandwidth	0	-	1%	% V_o nom
Ripple & Noise V3	20MHz bandwidth	0	-	2%	% V_o nom

Protection

All specifications apply over specified input voltage, output load, and temperature range, unless otherwise noted.

Parameter	Conditions/Description	Min	Nom	Max	Units
Input Fuse	T2.5A/250V internal fuse in both line & neutral	Not user accessible			
Input Transient Protection	2KV(CM) and 1KV(DM) surge			2	KV (CM)
Short Circuit Protection		Hiccup Mode			
Overload Protection		Hiccup Mode			
Overvoltage Protection	Latching Type, recycle AC input to reset	See models chart for trip ranges			

Characteristic Curves (Note: All waveforms below are based on CINT3110A0508K01 model)

Output vs. Temperature

80W convection cooled and 110W continuous with 200 LFM airflow. Derate output power to 50% at 70°C.

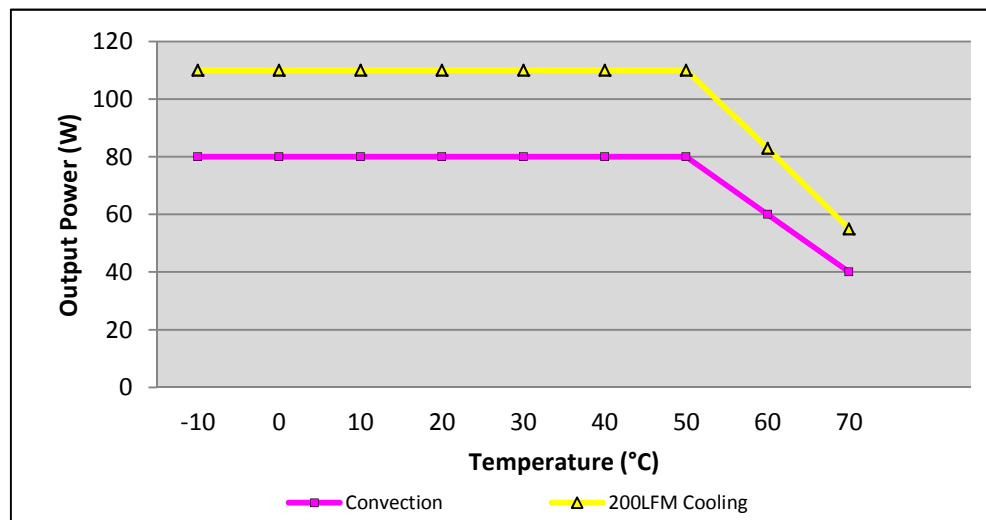

Ripple & Noise

To verify that the output ripple and noise does not exceed the level specified in the product specification. Measured using a scope probe socket with 0.1µF ceramic and a 10µF electrolytic capacitor connected in parallel across it, BW limit with 20MHz.

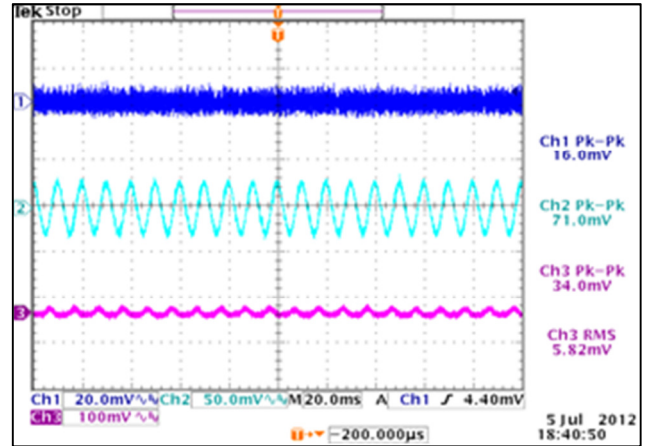
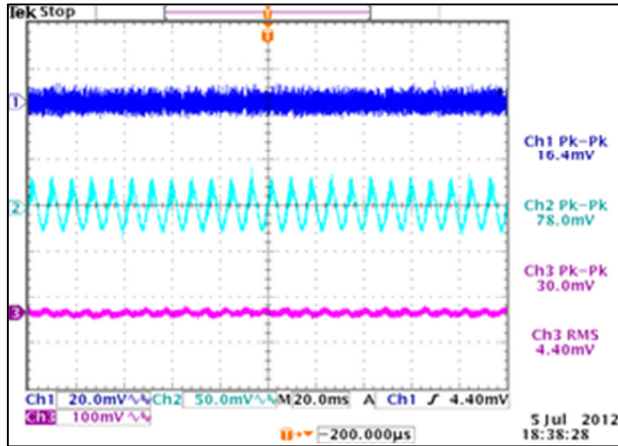

Output Transient Response V1

50% load step within the regulation limits of minimum and maximum load, di/dt<0.2A/µSec. Recovery time not specified as there is no laps in regulation with a 50% Load Step. Maximum voltage deviation is 3%.

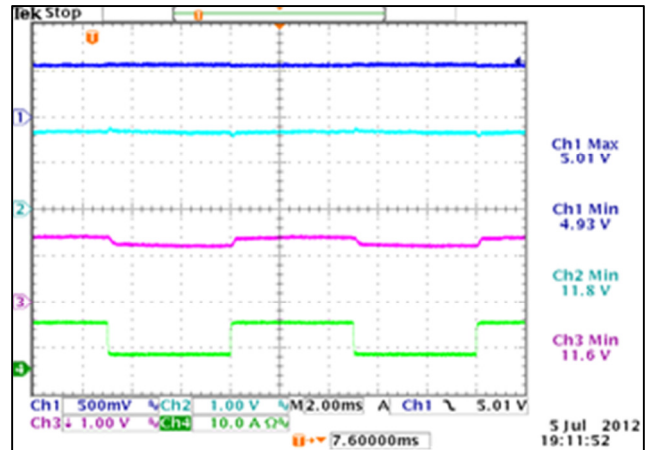
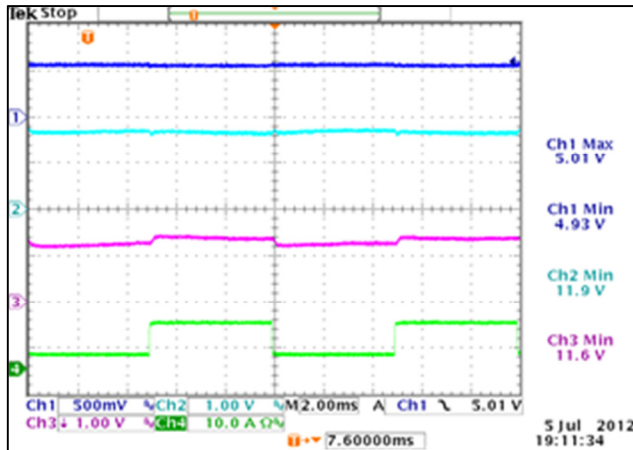

Output Transient Response V2

50% load step within the regulation limits of minimum and maximum load, di/dt<0.2A/µSec. Recovery time not specified as there is no laps in regulation with a 50% Load Step. Maximum voltage deviation is 3%.

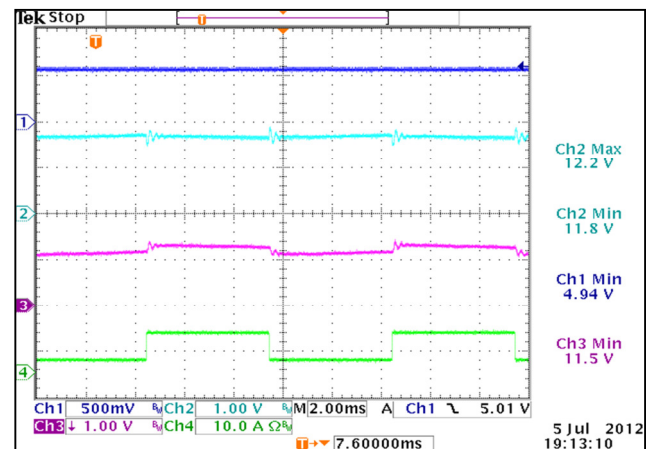
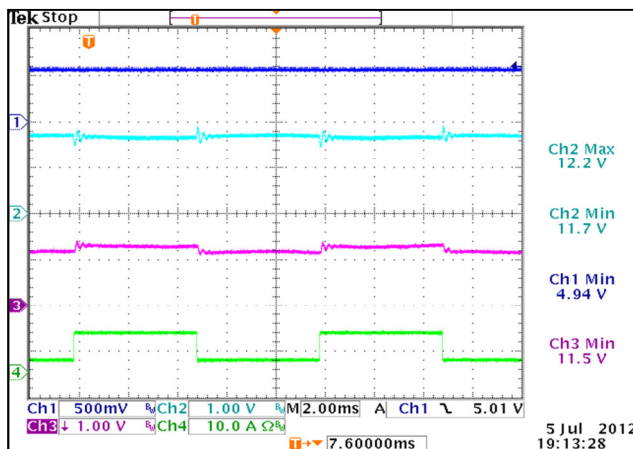

Output Transient Response V3

50% load step within the regulation limits of minimum and maximum load, $di/dt < 0.2A/\mu Sec$. Recovery time not specified as there is no laps in regulation with a 50% Load Step. Maximum voltage deviation is 3%.

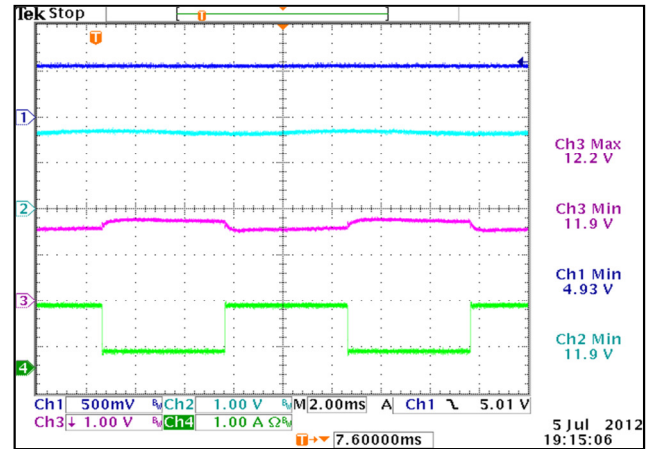
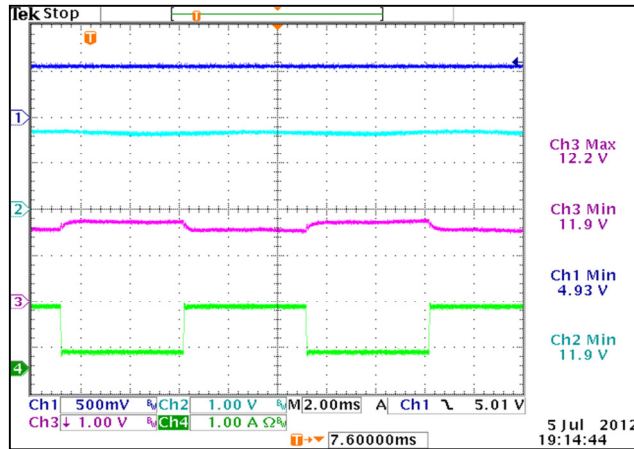

Output Overload Characteristic V1

Supply shall protect itself against Overload conditions. The Power Supply shall recover from Overload Conditions without operator intervention.

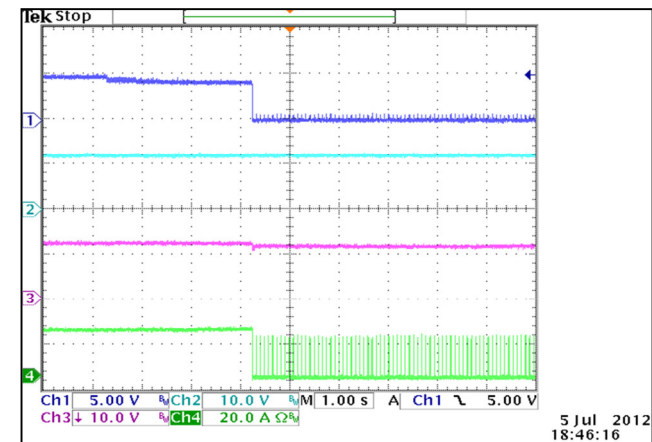
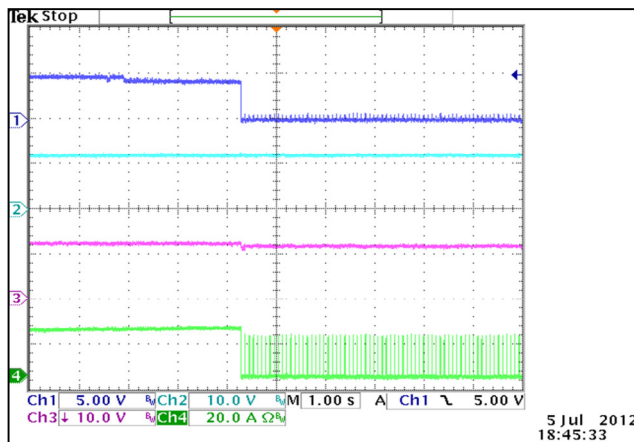

Output Overload Characteristic V2

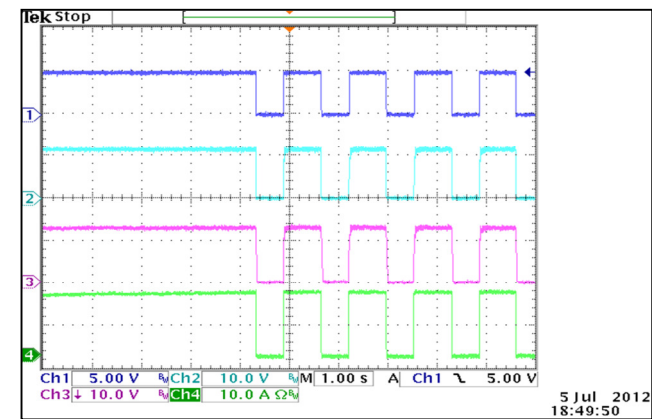
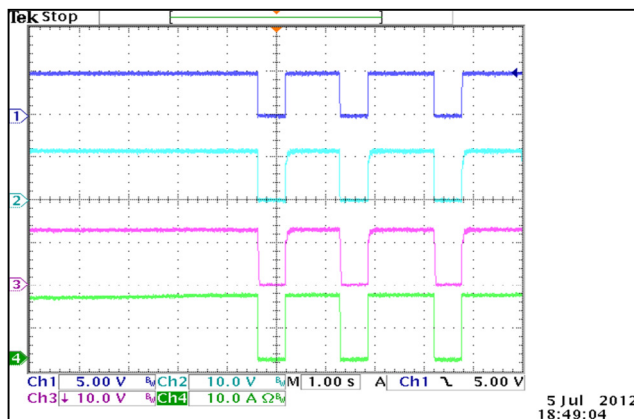

Output Overload Characteristic V3

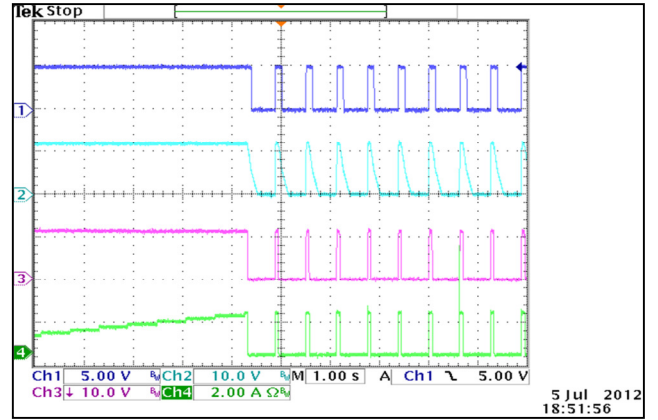
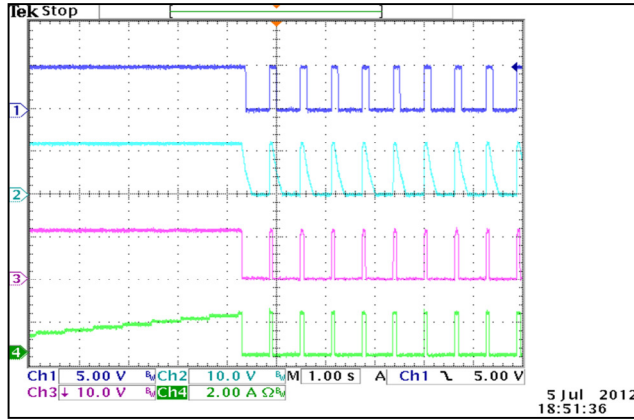

Output Short Circuit Characteristic V1

Supply shall protect itself against Short Circuit conditions. The Power Supply shall recover from short circuit conditions without operator intervention.

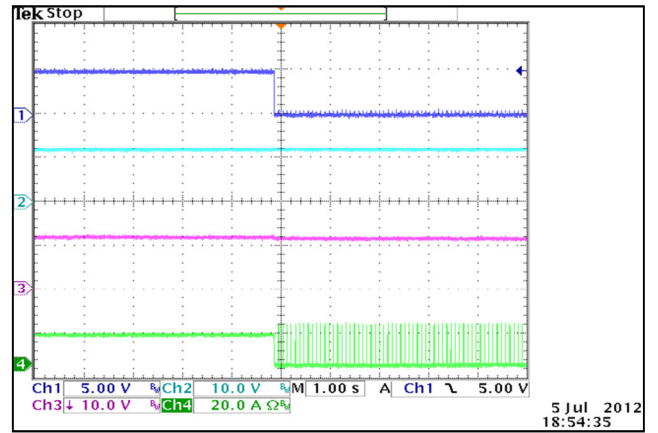
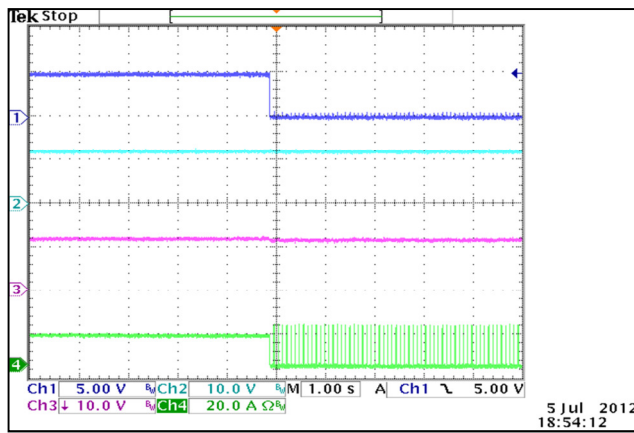

Output Short Circuit Characteristic V2

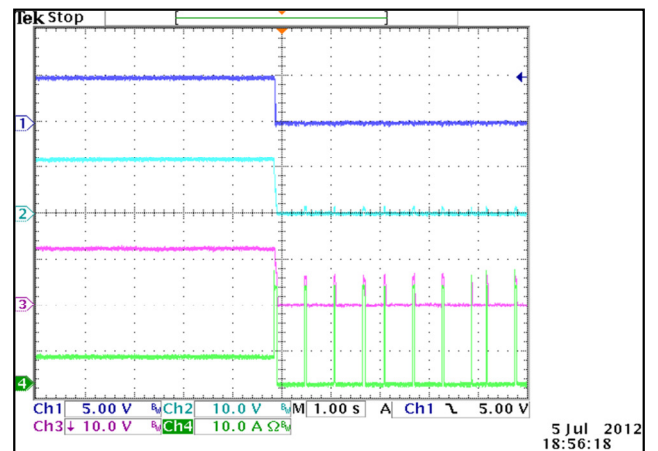
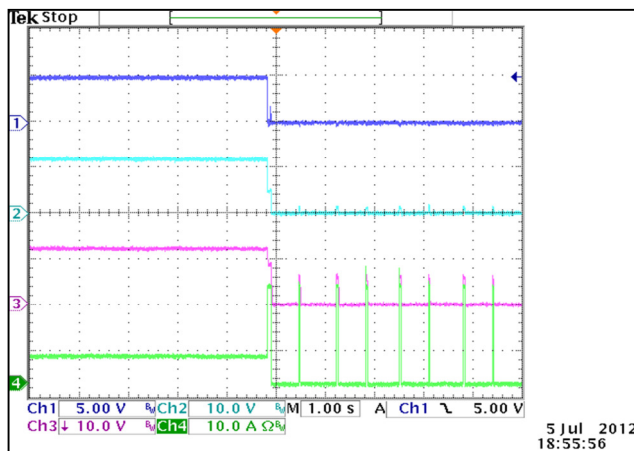

Output Short Circuit Characteristic V3

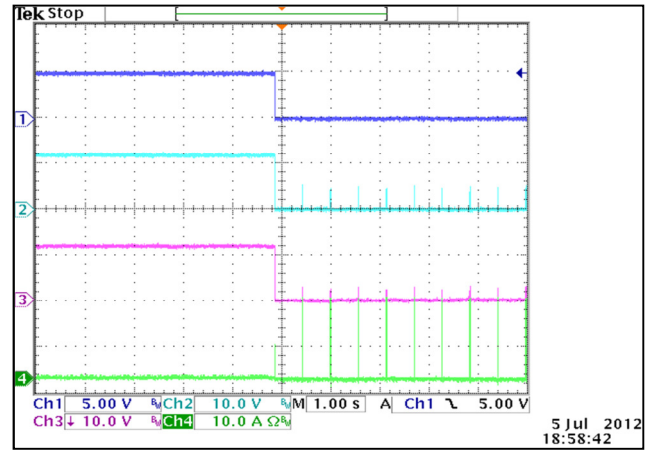
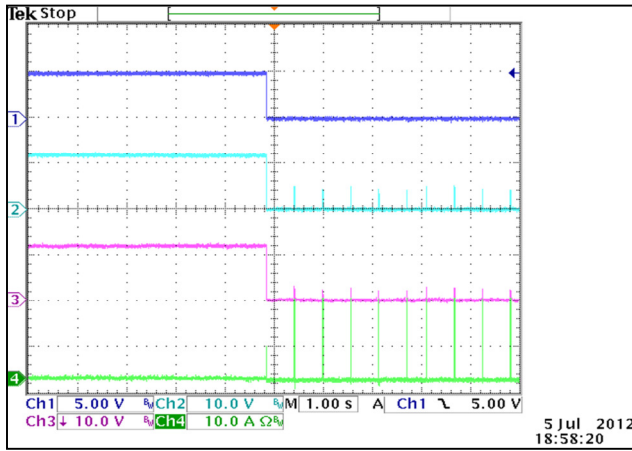

Output Overvoltage Characteristic V1

Supply shall protect itself against over voltage conditions. The Power Supply shall latch and require AC input recycle to reset.

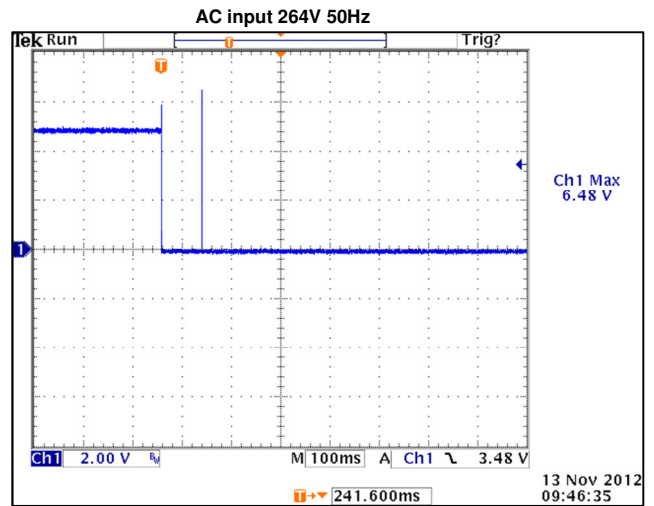
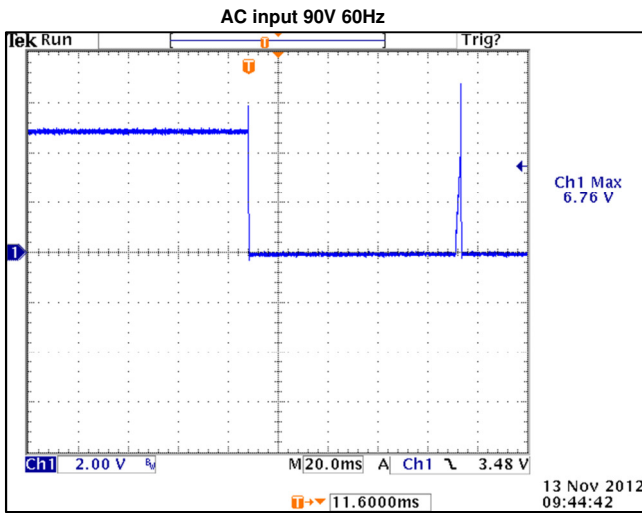

Output Overvoltage Characteristic V2

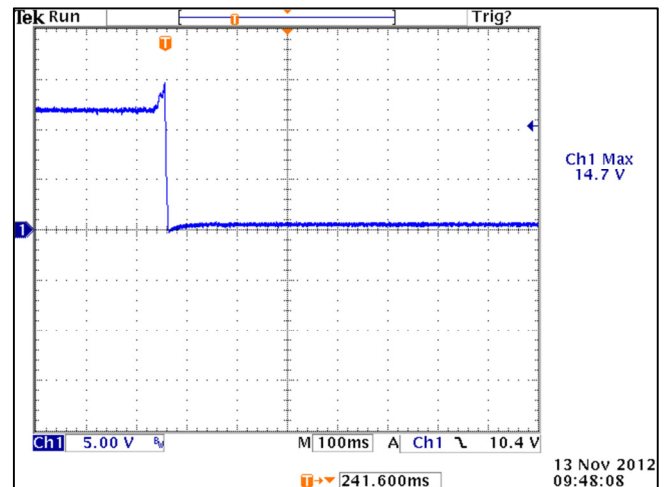
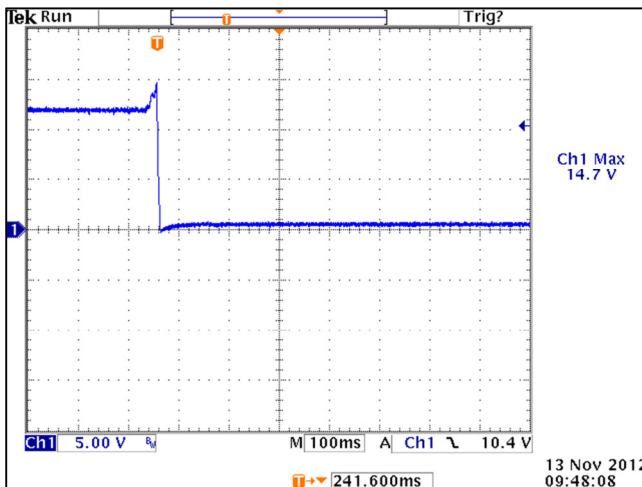

Output Overvoltage Characteristic V3

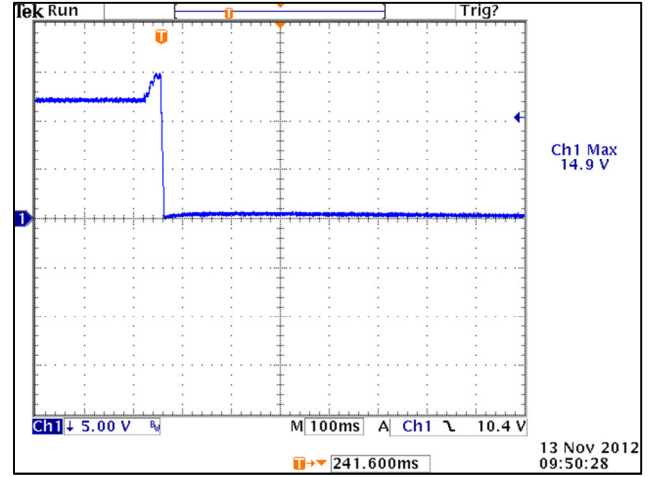
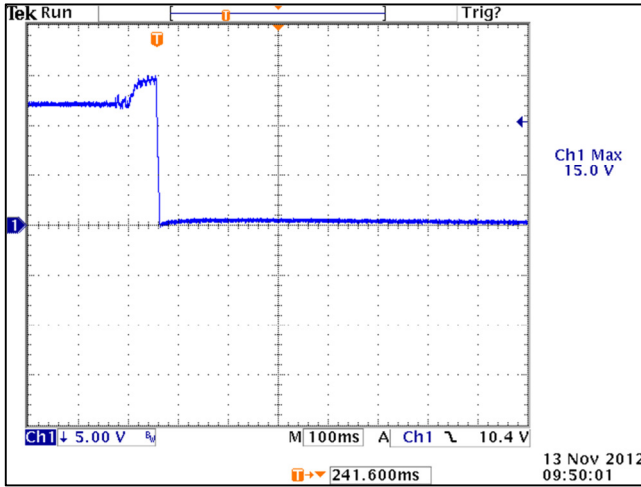

Startup Time

Start up time is <2seconds

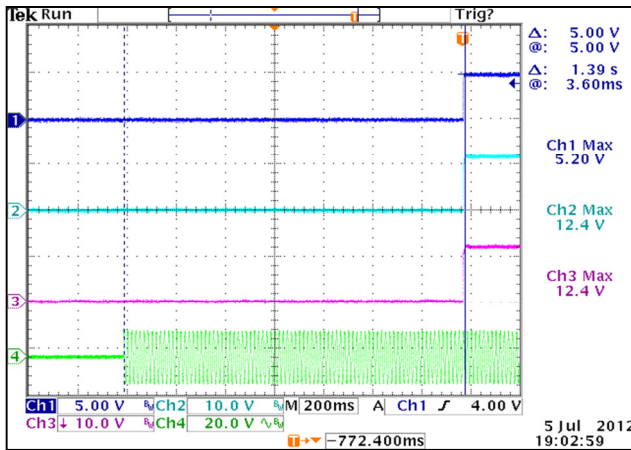

Hold-up Time

Hold up time is 16mS minimum

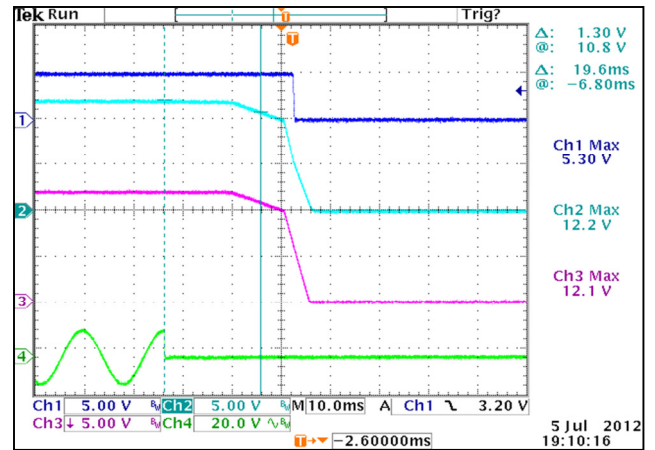

Power Fail Signal Timing

Active Low TTL logic signal goes high 100 - 500 ms after main output; it goes low at least 6 mS before loss of regulation.

