



FEATURES AND BENEFITS

3000W Fan-Cooled (Load & Temperature Controlled)

Approved to EN/CSA/IEC/UL62368-1

Programmable Output Current (0% ~ 105%)

Forced Current Sharing at Parallel Operation

Constant Current Limit

Selectable +5V/0.5A or +9V/0.3A Auxiliary Output

Remote Setting Multiple PSU via RS232, RS485 & I²C

Power OK Signal

Remote ON/OFF, Remote Sense Function

Protection: OVP, OLP, OTP, Fan Failure

3 Year Warranty

RoHS Compliant

Global Control via RS232

MODEL SELECTION

Model Number ⁴	Output Volts	Rated Current	Current Range	Output Power	Ripple & Noise ¹	Line Regulation	Load Regulation	Voltage Tolerance ³	Efficiency
TF3000A12K	12V	200A	0-200A	2400W	150mV pk-pk	±1%	±1%	±2%	88%
TF3000A15K	15V	160A	0-160A	2400W	150mV pk-pk	±1%	±1%	±2%	89%
TF3000A24K	24V	125A	0-125A	3000W	240mV pk-pk	±1%	±1%	±2%	91%
TF3000A36K	36V	83.3A	0-83.3A	3000W	360mV pk-pk	±1%	±1%	±2%	92%
TF3000A48K	48V	62.5A	0-62.5A	3000W	480mV pk-pk	±1%	±1%	±2%	92%
TF3000A60K	60V	50A	0-50A	3000W	600mV pk-pk	±1%	±1%	±2%	93%

Notes : 1. See CMD VS Output Curve.

2. Ripple & noise are measured at 20MHz of bandwidth by using a 12" twisted pair-wire terminated with a 0.1uF & 47uF parallel capacitor.

3. Tolerance: includes setup time tolerance, line regulation and load regulation.

4. Other output voltages available, consult factory.

5. Recovery after reset AC power ON or inhibit.

6. All specifications are typical at 230Vac, full load, at 25°C ambient unless noted.

INPUT

Input Voltage and Frequency ¹	100-240Vac, ±10%, 47-63Hz, 1Ø127-370Vdc
Input Current	115Vac: 19.7A (2000W output) 230Vac: 14.5A (3000W output)
Inrush Current	33A/115VAC, 65A/230VAC
Efficiency	See Model Selection Table
Power Factor	0.95/230VAC, 0.98/115VAC at full load
Leakage Current	< 3.5mA/240VAC

Notes : 1. De-rating may apply in low input voltage. Please check the de-rating curve for more details

OUTPUT

Output Voltage	See Model Selection Table on pg 1
Output Power ¹	3000W continuous (2400W for 12V, 15V models) – See model selection table for specific voltage model ratings
Voltage Range	±5.0% Typical adjustment by potentiometer (VR1)
Voltage Tolerance	See Model Selection Table on pg 1
Hold-Up Time	14ms/230VAC at full load
Turn On Time	800ms
Rise Time	100ms at full load
Ripple and Noise	See Model Selection Table on pg 1
Line/Load Regulation	See Model Selection Table on pg 1

Notes : 1. De-rating may apply in low input voltage. Please check the de-rating curve for more details

CONNECTOR INFORMATION

	Input Connector	Output Connector	Signal Connector
Pinout:	Term. 1) AC LINE Term. 2) NEUTRAL Term. 3) GROUND	+ and -	See Signal Connector Table on pg 3
Mating Connector /terminal:	#10 wire lugs	1/4-20 Wire Lugs	Connector: JST PHDR-24VS or equivalent Pins: JST SPHD-002T-P0.5 or equivalent



EMI/EMC COMPLIANCE

Conducted Emissions	Certified EN 55022; EN 61204-3; EN 61000-6-3
Radiated Emissions	Certified EN 55022; EN 61204-3; EN 61000-6-3
Electro-Static Discharge (ESD) Immunity on Power ports	EN55024/IEC61000-4-2
Radiated RF EM Fields Susceptibility	EN55022/EN61000-4-3
Electrical Fast Transients (EFT) /Bursts	EN55024/IEC61000-4-4
Surges, Line to Line (Diff Mode) and Line to GND (CMN Mode)	EN55024/IEC61000-4-5
Conducted Disturbances induced by RF Fields	EN55022/IEC61000-4-6
Rated Power frequency magnetic fields	EN55024/IEC1000-4-8
Voltage Interruptions, Dips, Sags & Surges	EN55024/IECEN61000-4-11
Harmonic Current Emissions	EN61000-3-2
Flicker Test	EN61000-3-3

Notes : 1. The power supply is considered a component which will be installed into a final equipment. The final equipment must be re-confirmed that it still meets EMC directives.

SAFETY

Safety Certifications	Approved to EN/CSA/IEC/UL62368-1
-----------------------	----------------------------------

RELIABILITY

MTBF	>112,000 hours per MIL-HDBK-217F
------	----------------------------------

ENVIRONMENT

Operating Temperature	-25 ~ +60°C (Refer to load de-rating curve)
Temperature Derating	See Derating Curve
Vibration	10 ~ 500Hz, 2G 10min./1 cycle, period for 60min. each along X, Y, Z axes Compliance to IEC 68-2-6, IEC 68-2-64
Dimensions	127 x 64 x 280mm 5.0 x 2.5 x 11.02 inch
Cooling	Load and temperature control fan
Relative Humidity	20% to 90%, non-condensing
Storage Temperature and Humidity	-40 ~ +85°C, 10 ~ 95% RH
Weight & Packing	2.6kg 6pcs/carton, 16.6kg/1.86CUFT

AUXILIARY SIGNALS

Auxiliary Power	Selectable +5V/0.5A or +9V/0.3A auxiliary output
Remote ON / OFF Control	By external switch
Power OK Signal	Open drain signal low when PSU turns on, Max. sink current: 20mA, Max. drain voltage: 40V
Output Voltage Trim	Adjustment of output voltage is between 0 ~ 105% of rated output
Output Current Trim	Adjustment of output current is between 0 ~ 105% of rated output
Parallel (Current Sharing) ¹	Please refer to Current Sharing with Remote Sensing (Parallel Connection) Diagram

Notes : 1. In parallel connection only one unit will operate if the total output load is less than 5% of the rated power.

PROTECTION

Overvoltage Protection	120 ± 7% of Vout, Latch Type (Recovery after reset AC power ON or inhibit). (Refer to VCI vs. OVP Curve)
Short Circuit Protection	Constant current, auto-recovery
Overtemperature Protection	85±5°C measured on NTC. Auto recovery
Overload Protection	105% of rated power, constant current type

ISOLATION SPECIFICATIONS

Isolation ¹	Input-Output: 3000Vac Input-Ground: 1500Vac Output-Ground: 500Vac
Isolation Resistance	I/P-O/P, I/P-FG, O/P-FG: 100M Ohms/500VDC

Notes : 1. This test is done without enclosure: I/P-O/P 4242VDC. If with enclosure: I/P-O/P 2121VDC, I/P-FG:2121VDC, O/P-FG: 707VDC



MECHANICAL DRAWING

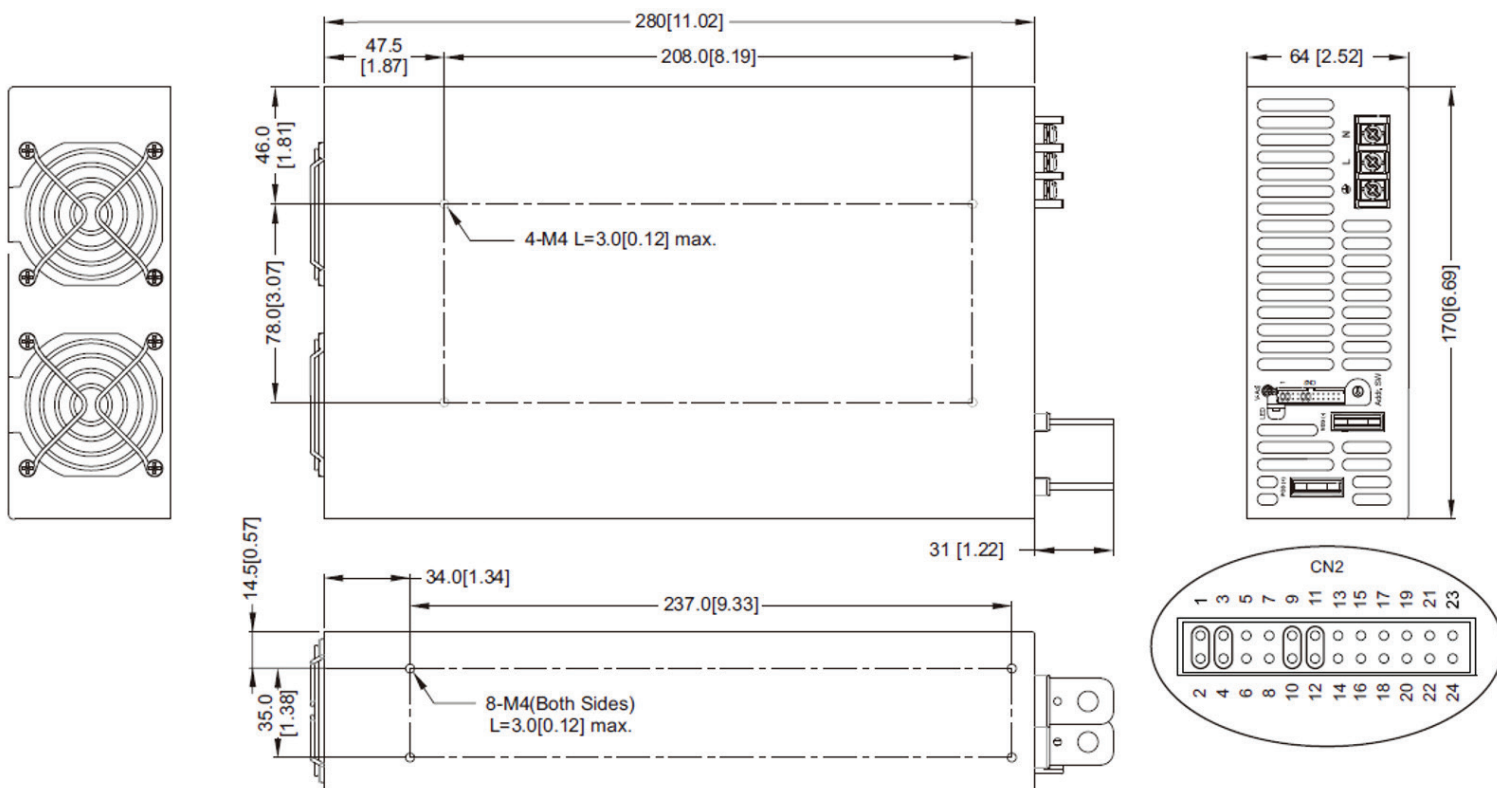







Recommended screw length is measured from the power supply surface.

SIGNAL CONNECTOR

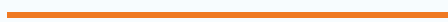
Pin No.	Function	Description	Pin No.	Function	Description
1	VS+	Remote sense (+)	13	ACI	I Program
2	VO+	Positive output voltage	14	GND	Ground
3	VS-	Remote sense (-)	15	VCI	V Program
4	VO-	Negative output voltage	16	GND	Ground
5	POK	Power OK	17	AUX	+5V/0.5A or +9V/0.3A Auxiliary power
6	GND	Ground	18	GND	Ground
7	PAR	Parallel operation current share	19	SCL	Serial Clock used in the I ² C Interface
8	VSET	Aux output setting	20	SDA	Serial Data used in the I ² C Interface
9	EN-	Inhibit ON/OFF (-)	21	AUX	+5V/0.5A or +9V/0.3A Auxiliary power
10	GND	Ground	22	GND	Ground
11	EN+	Inhibit ON/OFF (+)	23	RX	For RS232 Receiver function
12	AUX	+5V/0.5A or +9V/0.3A Auxiliary power	24	TX	For RS232 Transmission function

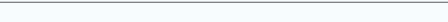

LED STATUS INDICATOR

LED	LED Signal	Status
Solid (Green)		Power OK (Local mode)
Solid (Orange)		Power OK (Remote mode)
Slow Blink (Green)		Power Standby
Fast Blink (Red)		Over Voltage Protection (OVP)
Solid (Red)		Over Load Protection (OLP)
Slow Blink (Red)		Over Temperature Protection (OTP)
Intermittent Blink (Red)		Fan Failure
Interlace Blink (Red)		Power Failure

REMOTE ON/OFF

(A) Default Setting

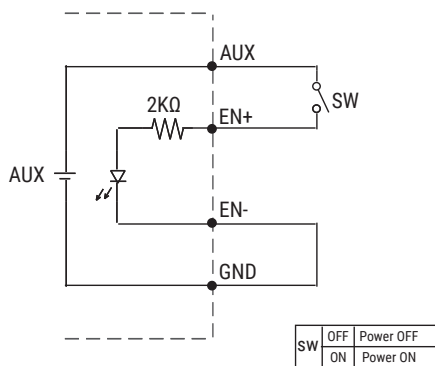

(A) Using internal 5V auxiliary source

(B)

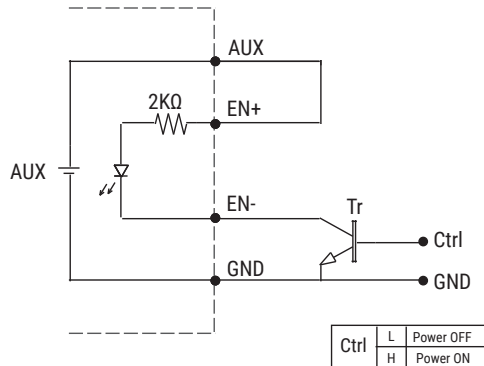

(B) ON / OFF Control by NPN transistor

(C)

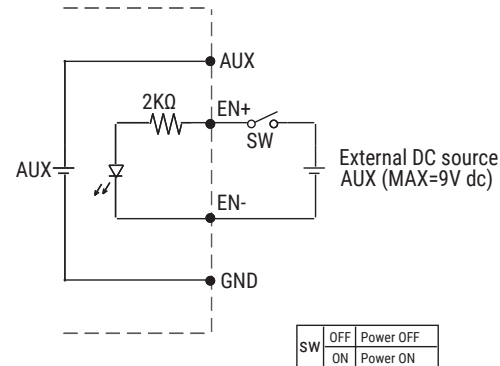

(C) Using external voltage source

GND shown in above diagram is referring to the GND of CN2, not the Grounding from main power(NEG-).

DERATING CURVE

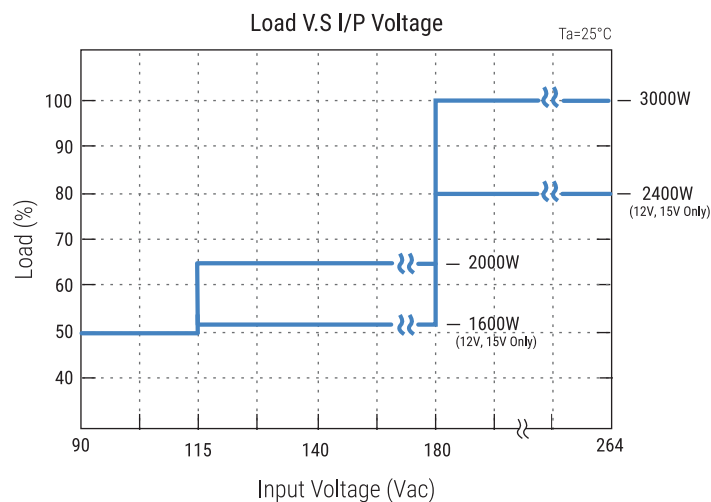
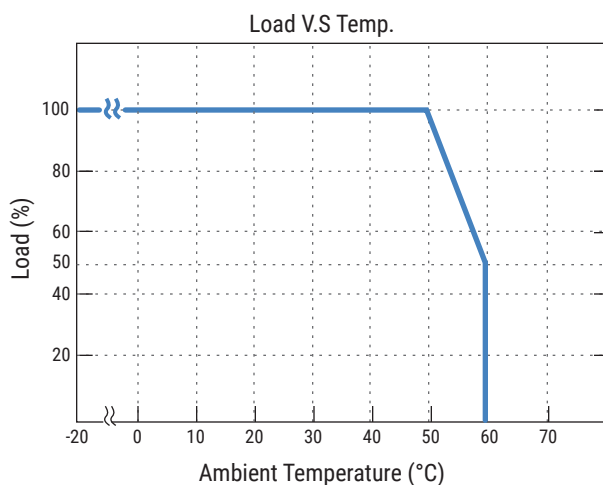



CMD vs Output Curve

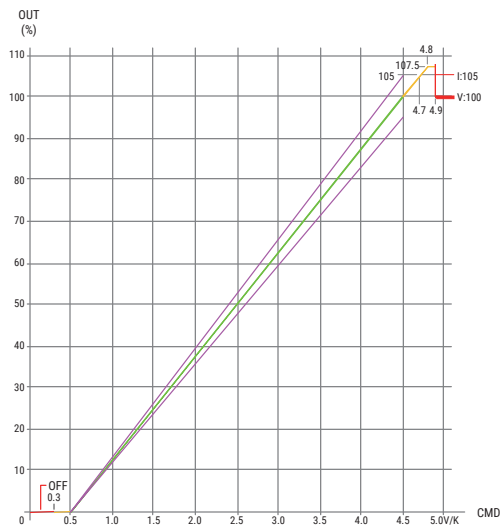

To ensure the power supply output voltage and current could be accurately adjusted, please make sure to adjust the output voltage and current > 10% vs. the rated voltage and current. (e.g. for a 24V unit, please adjust the DC output voltage above 2.4V to ensure accuracy; same applies to the output current)

VCI vs OVP Curve

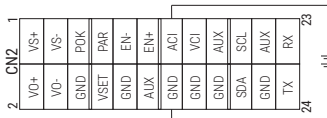
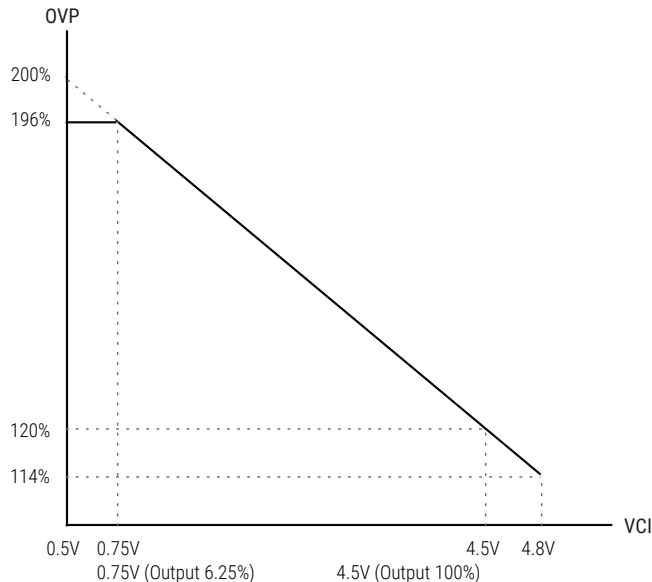

External Voltage (VDC)

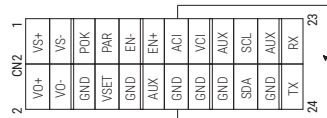

External Resistor (KΩ)

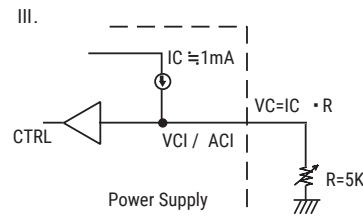
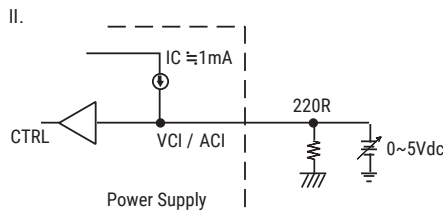
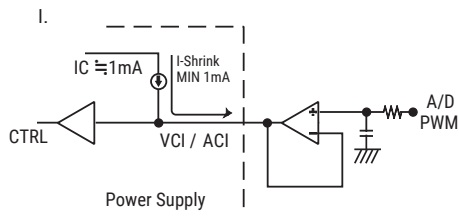

Power OK Signal & Auxiliary Power Setting

*The grounding of "AUX" power and P.OK signal should be connected to "GND" port. If "V0-" is connected as Grounding, make sure to short the GND and V0- ports.

Open drain signal low when PSU turns on. Max.
P.OK sink current: 20mA, Max, drain voltage: 40V.

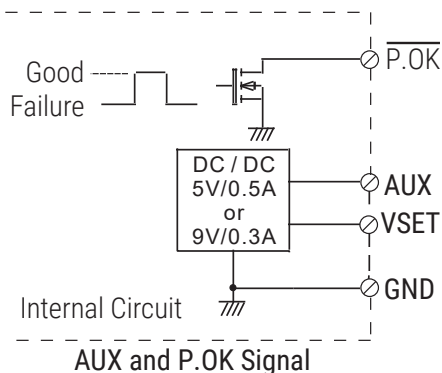

VSET	Open(Default Setting)	5V
	Short To GND	9V

*Place an additional capacitor to have a better performance of auxiliary power operation.

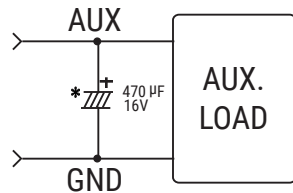

Do NOT exceed 5V/0.5A or 9V/0.3A



REMOTE SENSE

Remote Sense

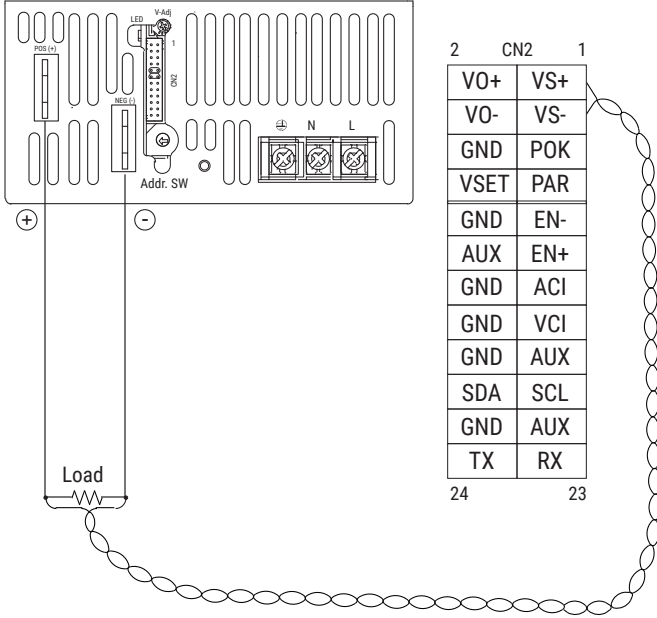

VS-, VS+ Compensation Voltage = <0.5V

Local Sense (Default Setting)

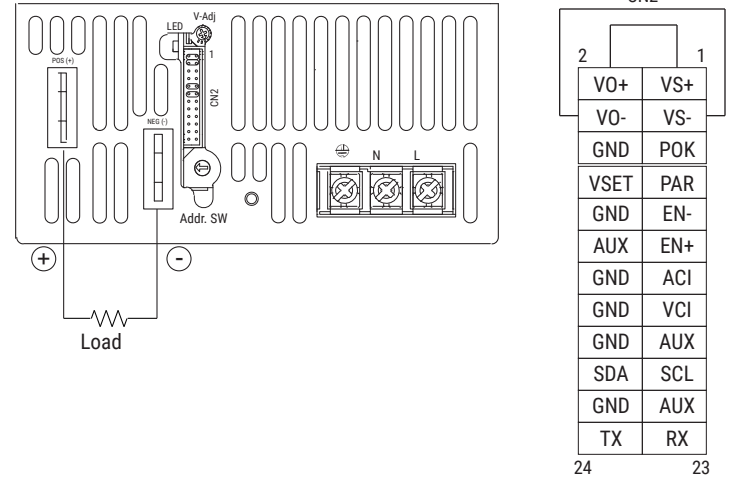

Current Sharing

Current Sharing with Remote Sensing (Parallel Connection)

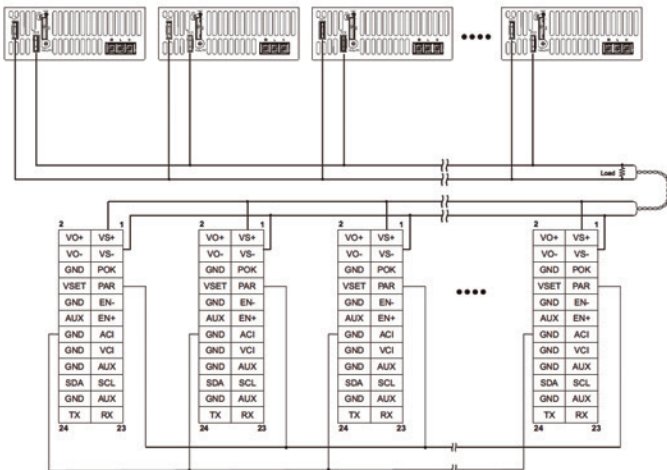

Connect PAR pins together for current sharing function

Current Sharing with Local Sensing

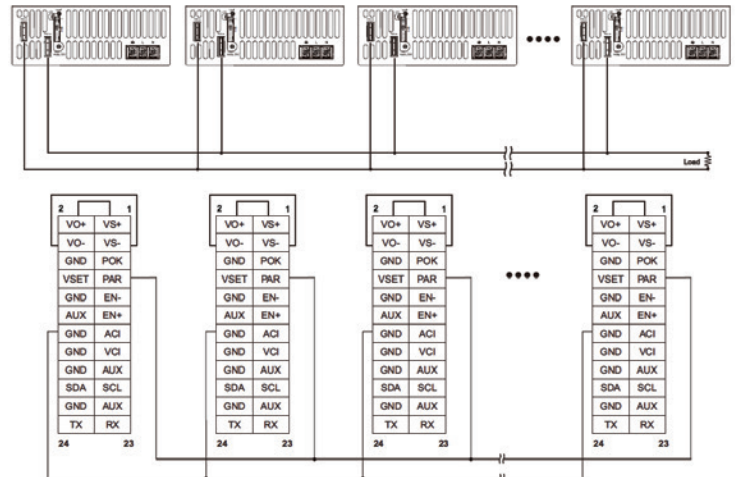

Connect PAR pins together for current sharing function



MOUNTING INSTRUCTIONS

Recommended standard mounting configurations

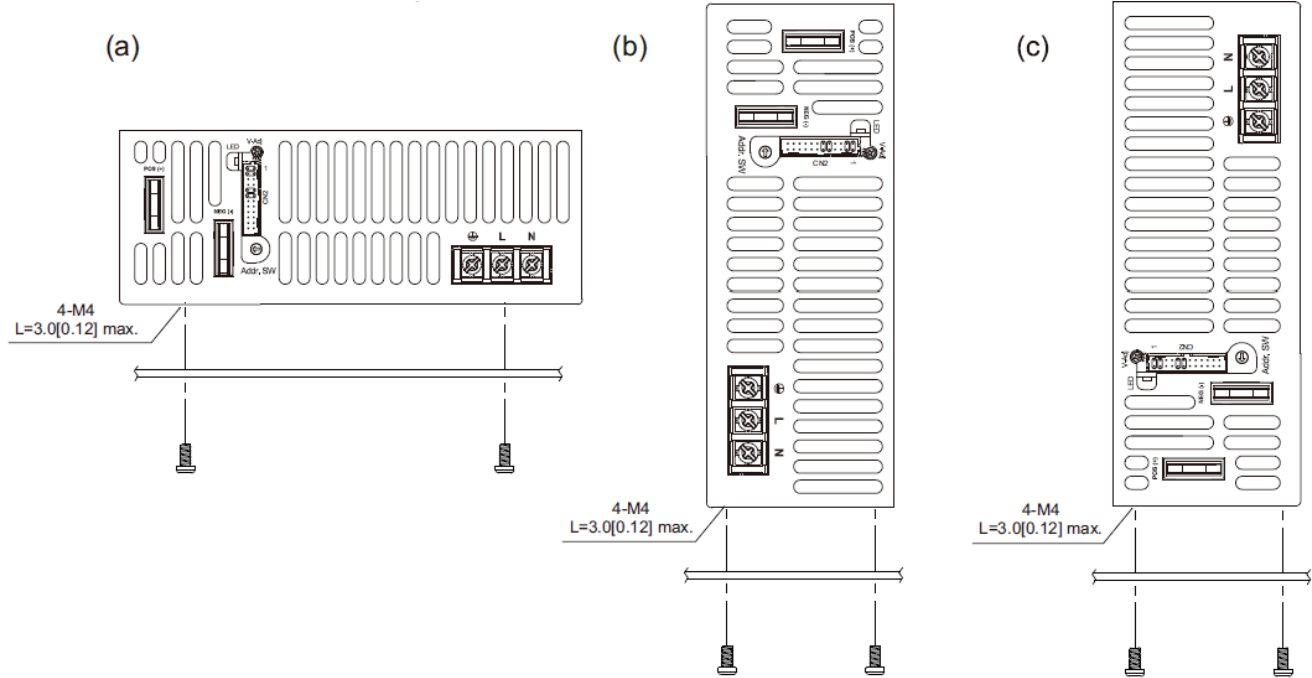

- Notes:
1. Recommended screw length is measured from the power supply surface.
 2. Ventilating holes on the front and back side panels should not be obstructed. Allow min. 50mm space for air flow. See below.
 3. Recommended torque of M4 mounting screws is $1.27\text{N} \cdot \text{m}$ ($13.0\text{kgf} \cdot \text{cm}$)

