

SERIES: CFM-92V | DESCRIPTION: DC AXIAL FAN

FEATURES

- omniCOOL™ bearing system
- 92 x 92 mm frame
- multiple speed options for different cooling needs
- tachometer signal and rotation detect options available
- auto restart protection standard on all models



MODEL	input voltage		input current ¹	input power ¹	rated speed ¹	air flow ²	static pressure ³	noise ⁴
	rated (Vdc)	range (Vdc)	max (mA)	max (W)	typ (RPM±10%)	(CFM)	(inch H ₂ O)	max (dBA)
CFM-9225V-117-177	12	4.5~13.8	54	0.65	1700 ⁵	28.4	0.05	17.7
CFM-9225V-124-280	12	4.5~13.8	87	1.05	2400	39.5	0.10	28.0
CFM-9225V-127-320	12	4.5~13.8	121	1.46	2700	45.0	0.13	32.0
CFM-9225V-130-340	12	4.5~13.8	161	1.94	3000	51.5	0.15	34.0
CFM-9225V-139-416	12	6.0~13.8	265	3.18	3900	65.0	0.25	41.6
CFM-9225V-142-437	12	6.0~13.8	322	3.87	4200	70.0	0.30	43.7
CFM-9225V-145-455	12	6.0~13.8	426	5.12	4500	75.0	0.35	45.5
CFM-9225V-224-280	24	8.0~27.6	51	1.23	2400	39.5	0.10	28.0
CFM-9225V-227-320	24	8.0~27.6	64	1.54	2700	45.0	0.13	32.0
CFM-9225V-230-340	24	8.0~27.6	87	2.09	3000	51.5	0.15	34.0
CFM-9225V-239-420*	24	10.0~27.6	178	4.28	3900	65.0	0.25	42.0
CFM-9225V-242-440*	24	10.0~27.6	207	4.97	4200	70.0	0.30	44.0
CFM-9225V-245-460*	24	10.0~27.6	253	6.08	4500	75.0	0.35	46.0
CFM-9225V-339-420*	48	24.0~56.0	119	5.72	3900	65.0	0.25	42.0
CFM-9225V-342-440*	48	24.0~56.0	125	6.00	4200	70.0	0.30	44.0
CFM-9225V-345-460*	48	24.0~56.0	144	6.92	4500	75.0	0.35	46.0

- Notes:
1. At rated voltage, 25°C, 0 inch H₂O static pressure, after 10 minutes
 2. As per AMCA 210 or DIN 24163, at rated voltage, stabilized RPM, 0 inch H₂O static pressure
 3. As per AMCA 210 or DIN 24163, at rated voltage, stabilized RPM, 0 CFM airflow.
 4. Measured in a semi-anechoic chamber with background noise < 15 dBA at 1 m from the fan intake.
 5. Typical rated speed is measured as RPM±15% at rated voltage.
 6. All specifications are measured at 25°C, 65% relative humidity unless otherwise specified.
- *. Discontinued models.

PART NUMBER KEY

CFM-9225V-117-177 - XX - CXX

Base Number

Fan Signals
 "blank" = no signals
 11 = rotation detector signal
 20 = tachometer signal

Reserved for Custom Configurations

INPUT

parameter	conditions/description	min	typ	max	units
operating input voltage ¹	12 Vdc input models	4.5	12	13.8	Vdc
	24 Vdc input models	10.0	24	27.6	Vdc
	48 Vdc input models	24.0	48	56.0	Vdc
starting voltage ²	12 Vdc input models		4.5		Vdc
	24 Vdc input models		8		Vdc
	48 Vdc input models		24		Vdc

Note: 1. See Model section on page 1 for specific input voltage ranges.
 2. The starting voltage for models CFM-9225V-139-416, CFM-9225V-142-437, and CFM-9225V-145-455 is 6 Vdc. The starting voltage for models CFM-9225V-239-420, CFM-9225V-242-440, and CFM-9225V-245-460 is 10 Vdc.

PERFORMANCE³

parameter	conditions/description	min	typ	max	units
rated speed	at rated voltage, 25°C, after 10 minutes	1700		4500	RPM
air flow	at 0 inch H ₂ O, see performance curves	28.4		75.0	CFM
static pressure	at 0 CFM, see performance curves	0.05		0.35	inch H ₂ O
noise	at 1 m	17.7		46.0	dBA

Note: 3. See Model section on page 1 for specific values.

PROTECTIONS / FEATURES⁴

parameter	conditions/description	min	typ	max	units
auto restart	on all models				
rotation detector signal	available on "11" models				
tachometer signal	available on "20" models				

Notes: 4. See Application Notes for details.

SAFETY & COMPLIANCE

parameter	conditions/description	min	typ	max	units
insulation resistance of frame	at 500 Vdc between internal stator and positive lead wire	10			MΩ
dielectric strength	apply 500 Vac for 1 minute between housing and positive lead wire				
safety approvals	UL/cUL 507, TUV (EN 60950-1)				
EMI/EMC	EN 61000-6-1:2007, EN 61000-6-3:2007+A1				
life expectancy	at 40°C, 65% RH		70,000		hours
RoHS	yes				

ENVIRONMENTAL

parameter	conditions/description	min	typ	max	units
operating temperature		-10		70	°C
storage temperature		-40		70	°C

PERFORMANCE CURVES

CFM-9225V-117-177

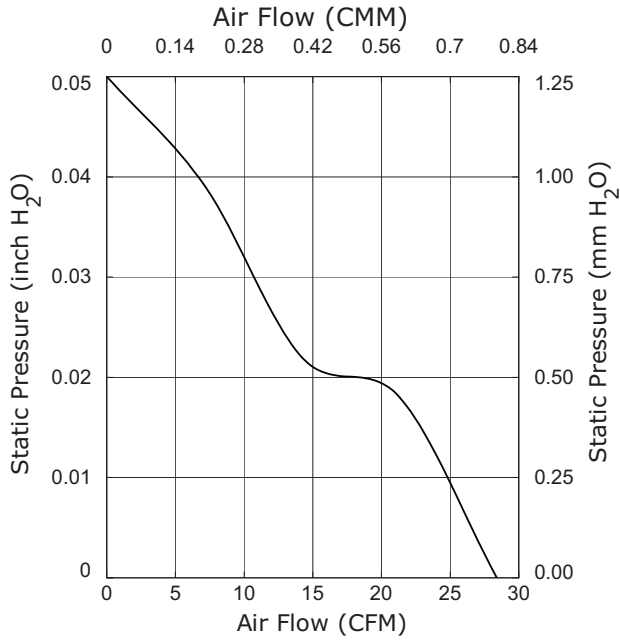

CFM-9225V-124-280

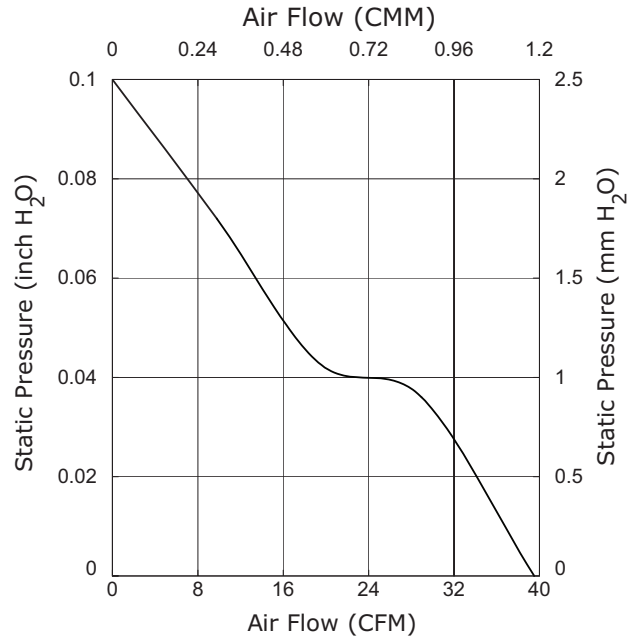

CFM-9225V-127-320

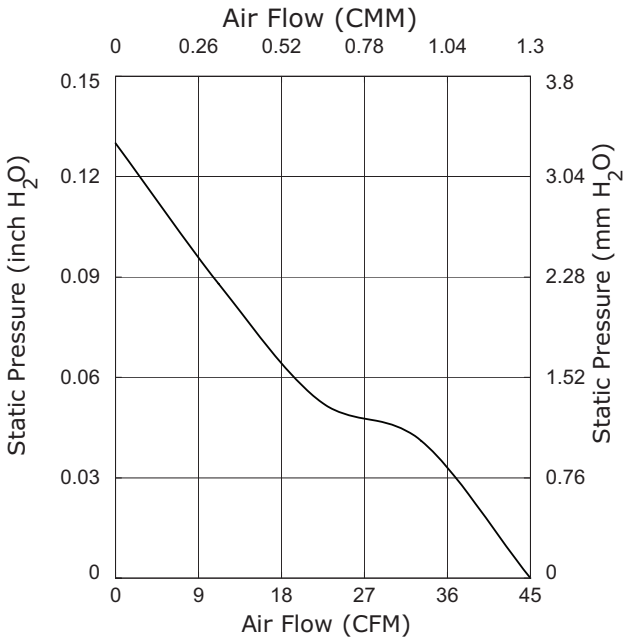

CFM-9225V-130-340

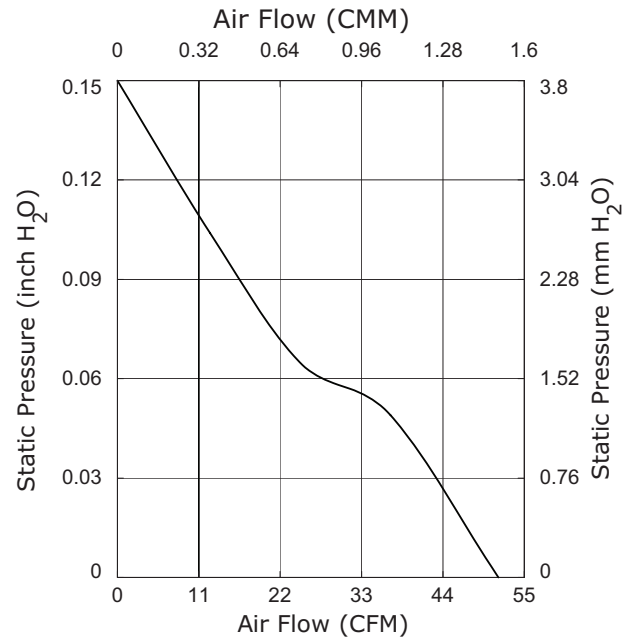

PERFORMANCE CURVES (CONTINUED)

CFM-9225V-139-416

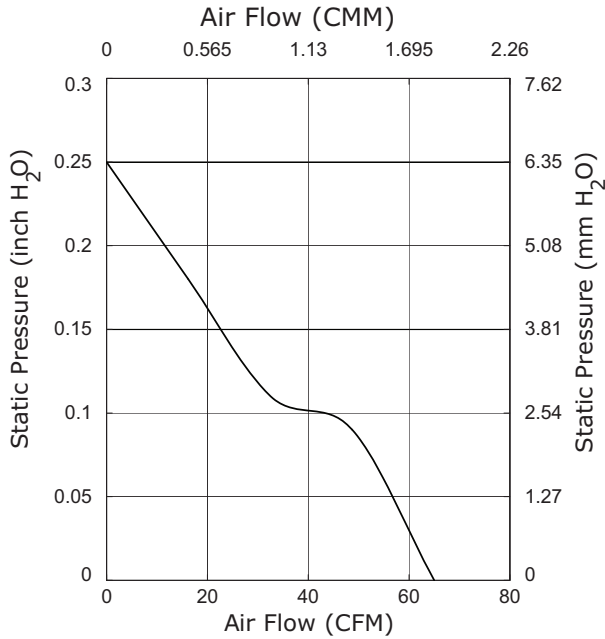

CFM-9225V-142-437

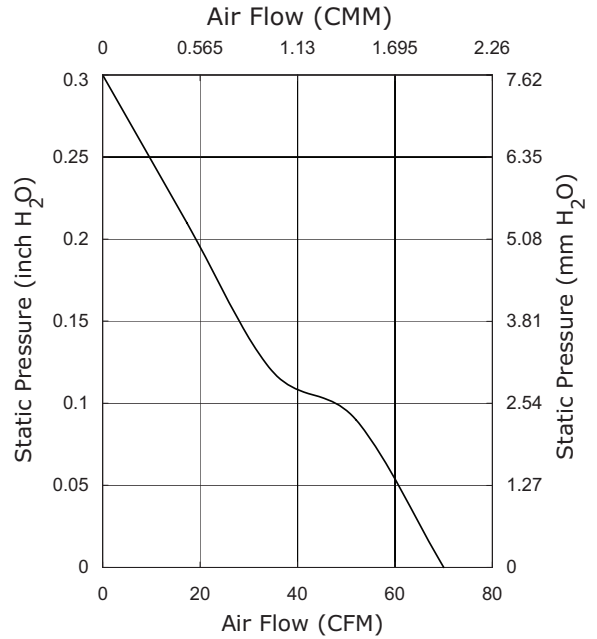

CFM-9225V-145-455

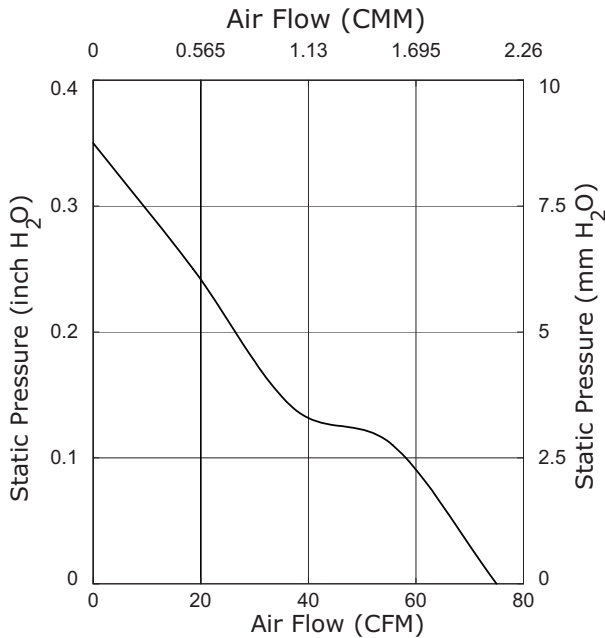

CFM-9225V-224-280

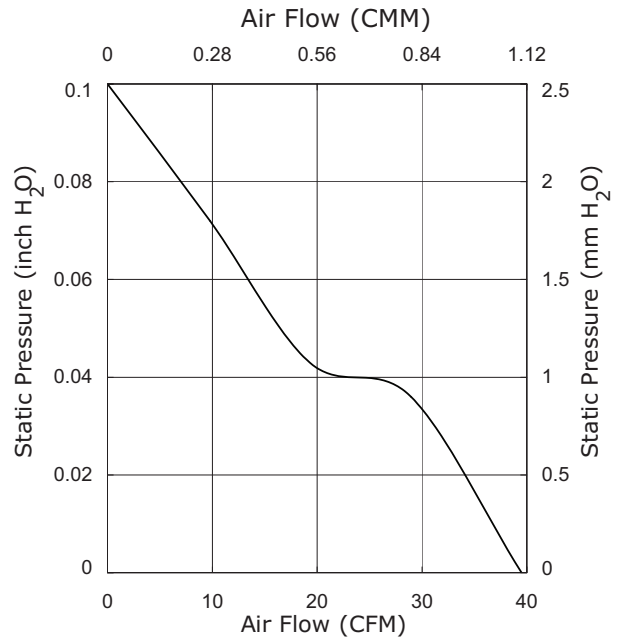

PERFORMANCE CURVES (CONTINUED)

CFM-9225V-227-320

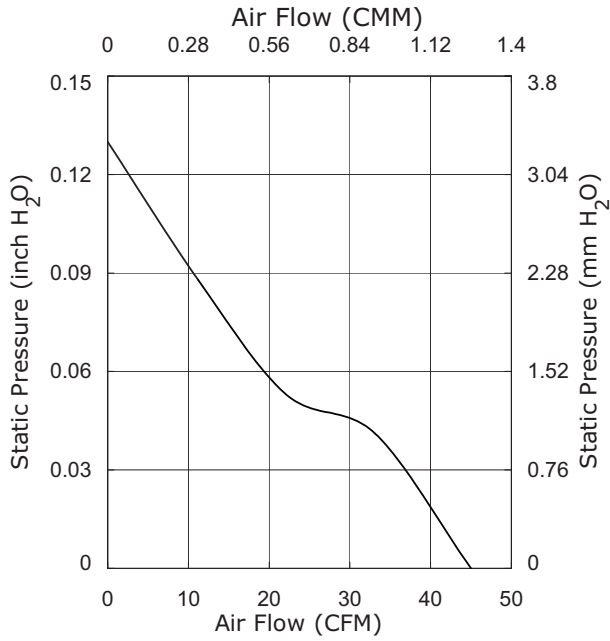

CFM-9225V-230-340

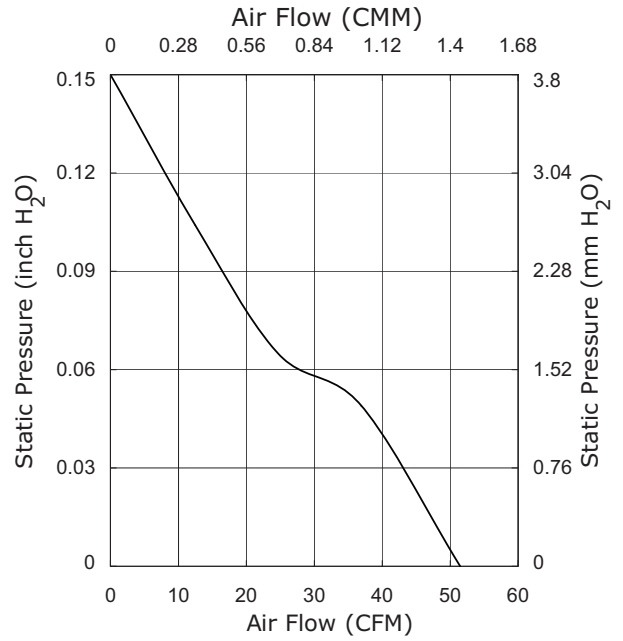

CFM-9225V-239-420

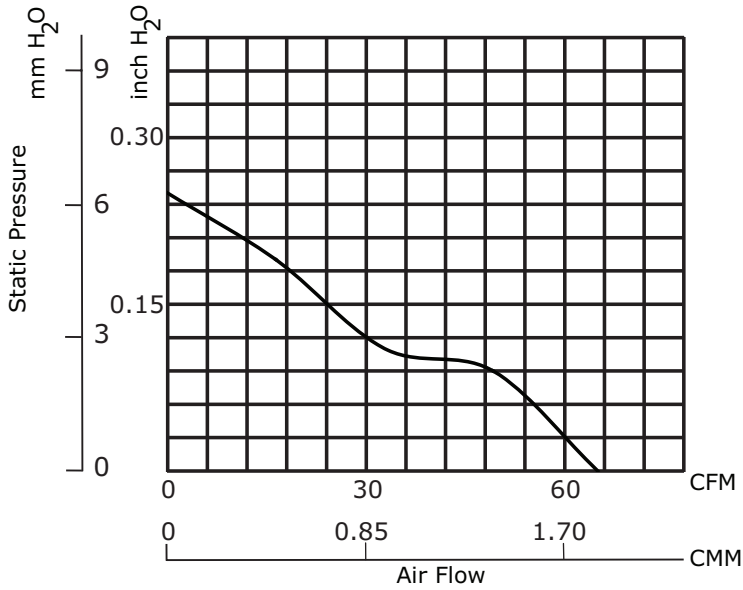

CFM-9225V-242-440

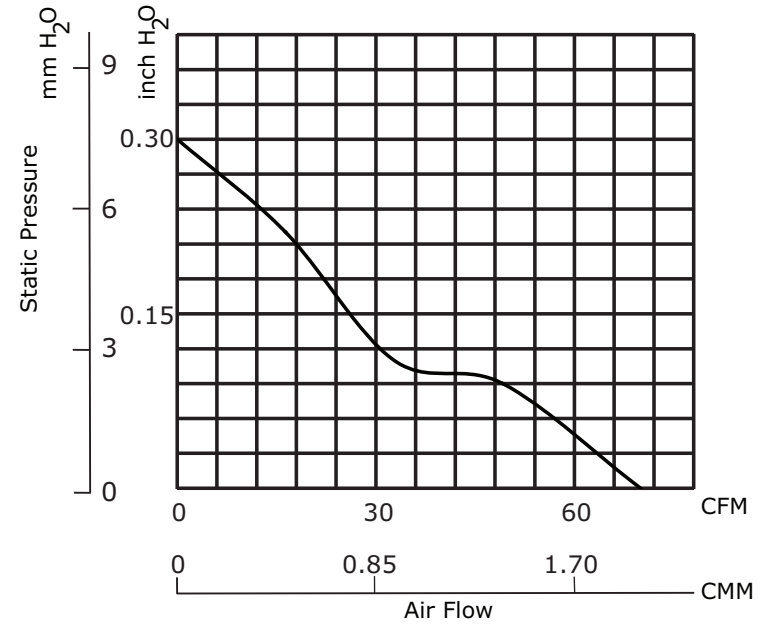

PERFORMANCE CURVES (CONTINUED)

CFM-9225V-245-460

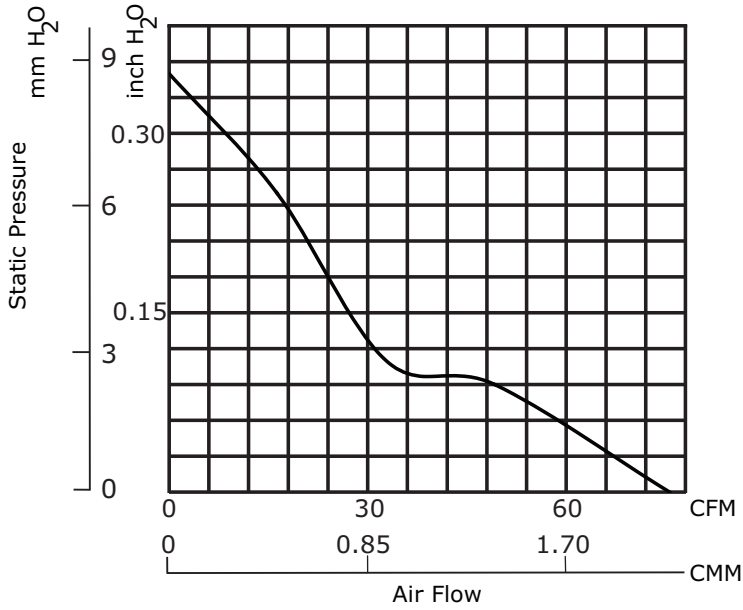

CFM-9225V-339-420

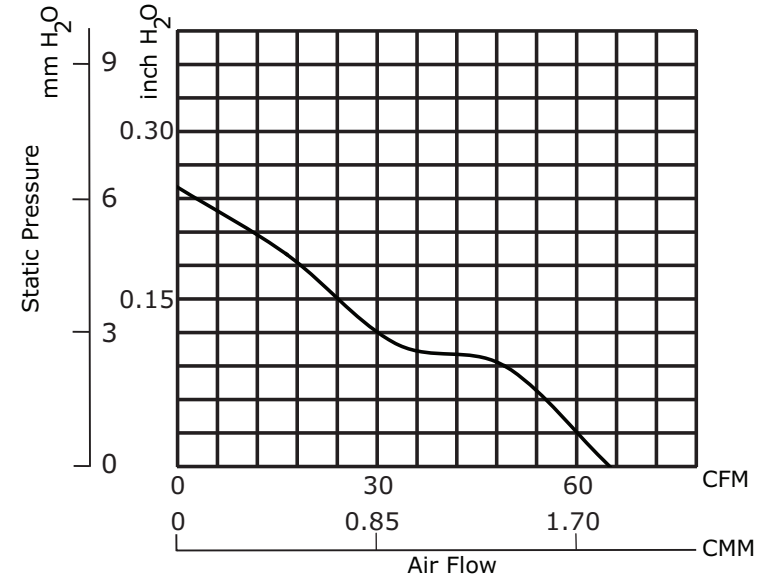

CFM-9225V-342-440

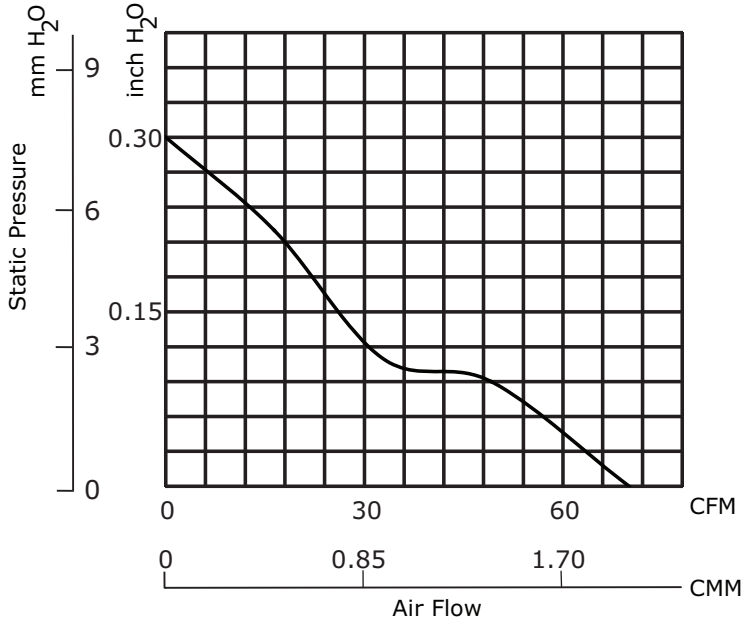

CFM-9225V-345-460

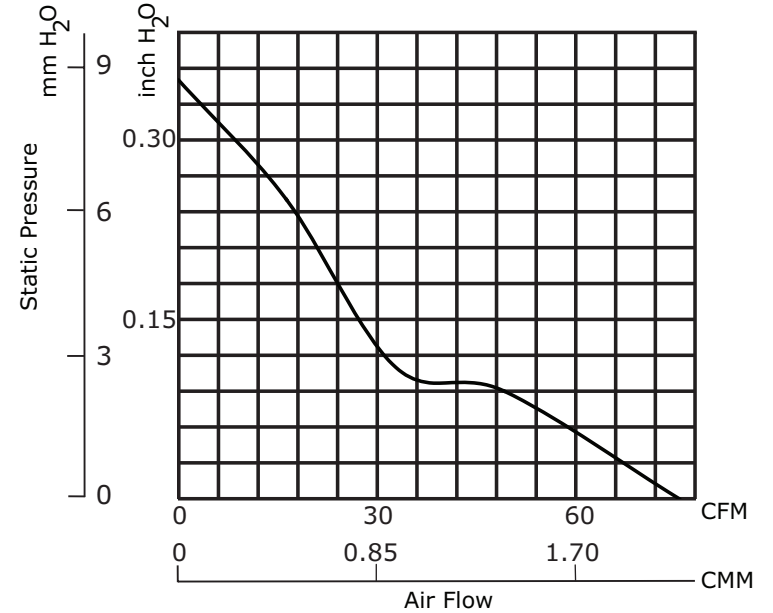

MECHANICAL

parameter	conditions/description	min	typ	max	units
motor	4 pole DC brushless				
bearing system	omniCOOL™				
direction of rotation	counter-clockwise viewed from front of fan blade				
dimensions	92 x 92 x 25				mm
material	PBT (UL94V-0)				
weight	1700~3000 RPM models		92		g
	12 Vdc input, 3900~4500 RPM models		106		g
	all other models		103		g

MECHANICAL DRAWING

units: mm

wire: UL 1007, 24 AWG

MOUNTING SCREW (Pan Head)			
Screw Type	Size	Standard	Torque
Machine Screw	M4	JIS B1111-1974	3~4 kgf-cm
Self-tapping Screw	M5	JIS B1122 Type 2	6~8 kgf-cm

WIRE CONNECTIONS	
Wire Color	Function
Red	+Vin
Black	-Vin
White ¹	RD Signal
Yellow ¹	Tach Signal

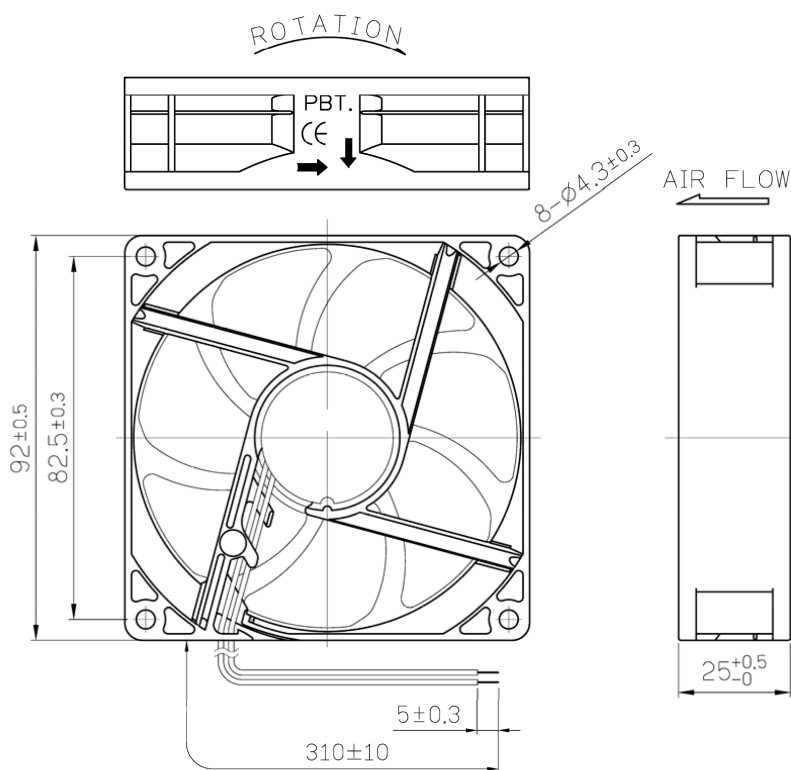

Notes: 1. Wires only present on versions with output signals.
2. 1700~3000 RPM models have 305 ±10 mm lead wires. 12 Vdc input, 3900~4500 RPM models have 300 ±20 mm lead wires.

APPLICATION NOTES

Auto Restart Protection

When the fan motor is locked by an external force, the device will temporarily turn off electrical power to the motor and restart automatically when the locked rotor condition is released.

Figure 1: Auto Start Protection

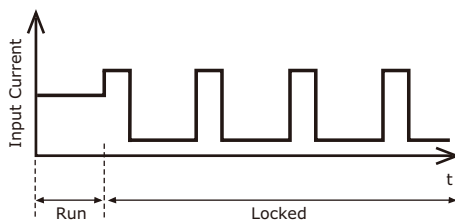

Rotation Detector Signal (White Wire)

The rotation detector signal is used to detect if the fan motor is operating or stopped. The output will be logical low (VL) when fan is operating and be logical high (Vcc) when fan motor is locked. (See Figures 2~3 below).

Figure 2: Rotation Detector Output Waveform

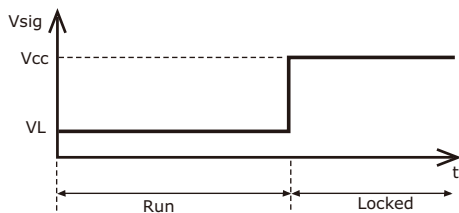
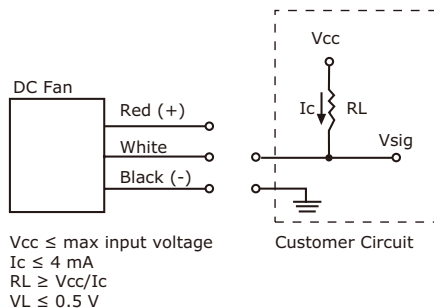

Figure 3: Rotation Detector Output Circuit



Tachometer Signal (Yellow Wire)

The tachometer signal is for detecting the rotational speed of the fan motor. The output will be a square wave when fan is operating and logical high (Vcc) when fan motor is locked (See Figures 4~5 below). The relationship between RPM & output pulses from the signal wire is as follows.

$$1 \text{ RPM} = 2 \text{ Pulses}$$

Figure 4: Tachometer Output Waveform

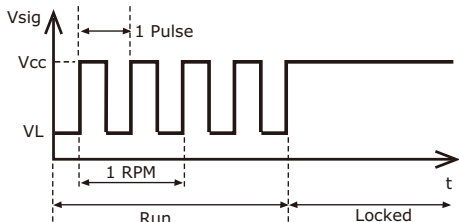
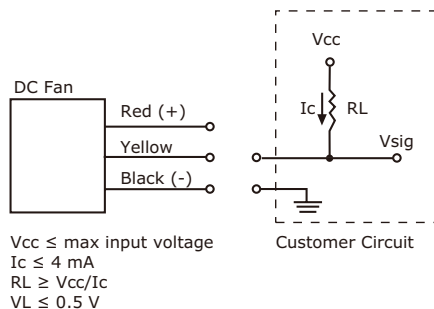

Figure 5: Tachometer Output Circuit



SAFETY CONSIDERATIONS

1. Do not use or operate this fan in excess of the limitations set forth in this specification. CUI is not responsible for the non-performance of this fan and/or any damages resulting from its use, if it is not used or operated in accordance with the specifications.
2. CUI recommends adding a protection circuit to the product or application in which this fan is installed, such as a thermo-fuse, or current fuse or thermo-protector. The failure to use such a device may result in smoke, fire, electric shock by insulation degradation in cases of motor lead short circuit, overload, or over voltage, and/or other failure.
3. CUI recommends installing a protection device to the product or application in which this fan is installed if there is a possibility of reverse connection between Vdc (+) and GND (-). The failure to install such a device may result in smoke, fire, and/or destruction, although these conditions may not manifest immediately.
4. This fan must be installed and used in compliance with all applicable safety standards and regulations.
5. Use proper care when handling and/or installing this fan. Improper handling of installation of this fan may cause damage that could result in unsafe conditions.
6. Use proper care during installation and/or wiring. Failure to use proper care may cause damage to certain components of the fan including, but not limited to, the coil and lead wires, which could result in smoke and/or fire.
7. Do not use power or ground PWM to control the fan speed. If the fan speed needs to be adjusted, please contact CUI to customize the product design for your application.
8. For critical or extreme environments, including non-stop operation, please contact CUI and we will gladly provide assistance with your product selection to ensure an appropriate cooling product for your application.
9. When building your device, please examine thoroughly any variation of EMC, temperature rise, life data, quality, etc. of this product by shock/drop/vibration testing, etc. If there are any problems or accidents in connection with this product, it should be mutually discussed and examined.
10. Use proper care when handling these fans. Components such as fan holders or bearings may be damaged, if touched with fingers or other objects. Additionally, static electricity (ESD) may damage internal circuits of the fan.
11. Do not operate these fans in proximity to hazardous materials such as organic silicon, cyanogens, formalin, phenol, or corrosive gas environments including, but not limited to, H_2S , SO_2 , NO_2 , or Cl_2 .
12. CUI recommends that you protect these fans from exposure to outside elements such as dust, condensation, humidity, or insects. Exposure of this fan to such elements may affect its performance and may cause safety hazards. CUI does not warrant against damage to the product caused by outside elements.
13. The fans must be installed properly and securely. Improper mounting may cause harsh resonance, vibration, and noise.
14. Do not store these fans in an environment with high humidity. These fans must be stored in accordance with the specified storage temperature.
15. CUI reserves the right to use components from multiple sources at its discretion. The use of components from other sources will not affect the specifications as described herein.
16. The life expectancy of these fans has not been evaluated for use in combination with any end application. Therefore, the life expectancy that relate to these fans are only for reference.

REVISION HISTORY

rev.	description	date
1.0	initial release	07/31/2017
1.01	discontinued CFM-9225V-242-440, CFM-9225V-339-420, CFM-9225V-342-440, CFM-9225V-345-460 models	09/12/2018
1.02	discontinued CFM-9225V-239-420, CFM-9225V-245-460 models	03/18/2019
1.03	brand update	02/10/2020

The revision history provided is for informational purposes only and is believed to be accurate.

CUI DEVICES

CUI Devices offers a one (1) year limited warranty. Complete warranty information is listed on our website.

CUI Devices reserves the right to make changes to the product at any time without notice. Information provided by CUI Devices is believed to be accurate and reliable. However, no responsibility is assumed by CUI Devices for its use, nor for any infringements of patents or other rights of third parties which may result from its use.

CUI Devices products are not authorized or warranted for use as critical components in equipment that requires an extremely high level of reliability. A critical component is any component of a life support device or system whose failure to perform can be reasonably expected to cause the failure of the life support device or system, or to affect its safety or effectiveness.