

# Dialight

## Micro LED<sup>®</sup> SMD LED "598 SERIES" 1208 PACKAGE (3.2mm X 1.5mm X 1.0mm) Single Color Right Angle

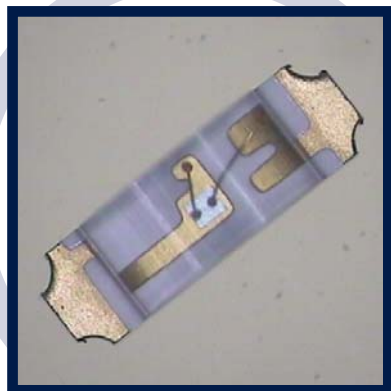

### FEATURES / BENEFITS

- ▲ Compatible with automatic placement equipment
- ▲ RoHS compliant
- ▲ Moisture sensitivity level 3
- ▲ Packaged in 8mm tape, 7" reel and 20 per strip
- ▲ Meets EIA-481-1 pkg. std.

#### Package Outline Drawing:

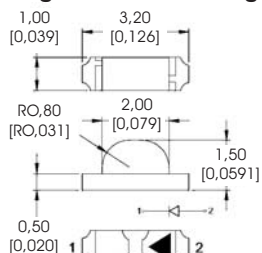

Notes 1. All dimensions are in mm [inches];  
2. Tolerances are  $\pm 0.1\text{mm}$  [0.004inch] unless noted.

### ORDERING INFORMATION

5 9 8 - 8 3 1 0 - 1 1 7 F

Packaging Options

2	20 pieces on tape
7	7" reel 3,000pcs / reel

### PART NUMBERS

DIALIGHT P/N	EMITTED COLOR	MATERIAL	LENS COLOR	LUMINOUS INTENSITY			DOMINANT WAVE-LENGTH			FORWARD VOLTAGE			VIEWING ANGLE
				If = 20 mA			If = 20 mA			If = 20 mA			° DEGREES
				MIN	TYP	MAX	MIN	TYP	MAX	MIN	TYP	MAX	
598-8310-117F	RED	AllnGaP	WATER CLEAR	43	-	70	630	635	640	1.8	2	2.4	160
598-8320-117F	RED-ORANGE	AllnGaP	WATER CLEAR	80	120	230	620	625	630	1.8	2	2.4	160
598-8330-117F	ORANGE	AllnGaP	WATER CLEAR	80	110	150	600	—	610	1.8	2	2.4	160
598-8340-117F	YELLOW	AllnGaP	WATER CLEAR	100	140	180	587	—	597	1.8	2	2.4	160
598-8350-117F	YELLOW	AllnGaP	WATER CLEAR	100	140	180	582	—	587	1.8	2	2.4	160
598-8360-117F	YELLOW-GREEN	AllnGaP	WATER CLEAR	43	54	100	570	—	575	1.8	2	2.4	160
598-8370-117F	GREEN	AllnGaP	WATER CLEAR	18	28	43	560	—	570	1.8	2	2.4	160
598-8380-117F	GREEN	InGaN	WATER CLEAR	350	480	650	515	520	525	2.8	3.2	3.4	160
598-8391-117F	BLUE	InGaN	WATER CLEAR	100	140	230	470	473	475	2.8	3.2	3.5	160

### ABSOLUTE RATINGS (@ Ta = 25°C)

DIALIGHT P/N	POWER DISSIPATION	FORWARD CURRENT	REVERSE VOLTAGE	OPERATING TEMPERATURE RANGE	STORAGE TEMPERATURE RANGE	PEAK PULSE FORWARD CURRENT	ELECTROSTATIC DISCHARGE
	(mW)	(mA)	(V)	(°C)	(°C)	(°C)	(HBM)
598-8310-117F	48	20	5	-40~+100	-40~+100	100	2000
598-8320-117F	48	20	5	-40~+100	-40~+100	100	2000
598-8330-117F	48	20	5	-40~+100	-40~+100	100	2000
598-8340-117F	50	20	5	-40~+100	-40~+100	100	2000
598-8350-117F	50	20	5	-40~+100	-40~+100	100	2000
598-8360-117F	48	20	5	-40~+100	-40~+100	100	2000
598-8370-117F	48	20	5	-40~+100	-40~+100	100	2000
598-8380-117F	68	20	5	-40~+100	-40~+100	100	1000
598-8391-117F	70	20	5	-40~+100	-40~+100	100	1000



### MECHANICAL DIMENSIONS

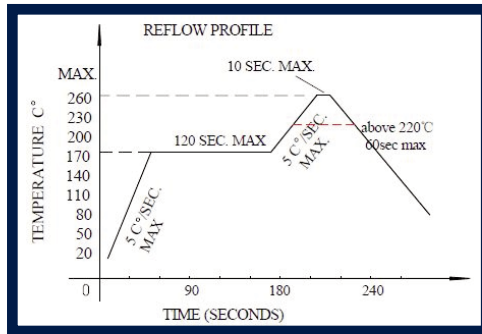
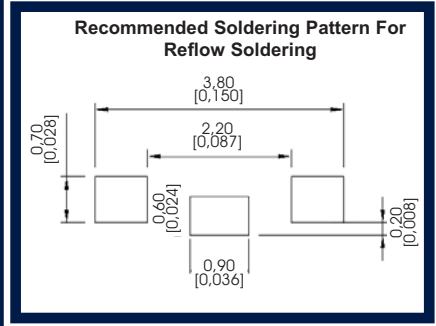
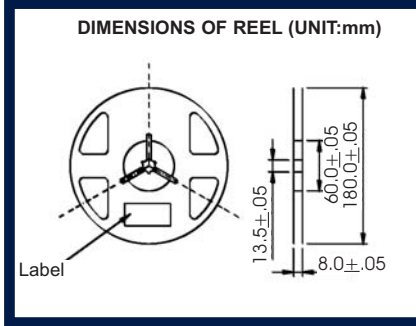
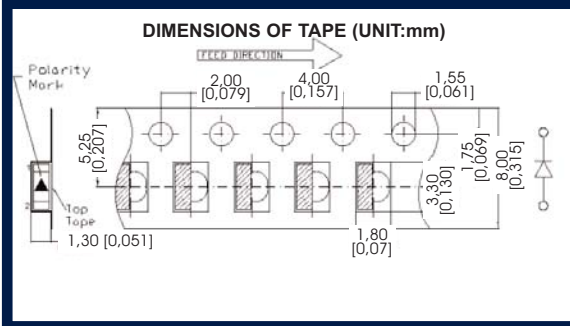

	REFLOW SOLDERING	HAND SOLDERING
Pre-heat	160~180°C	Temperature 300°C Max.
Pre-heat time	120 seconds Max.	
Peak temperature	260°C Max.	Soldering time 3 second Max (one time only)
Soldering time	10 seconds Max.	
Condition	Refer to temperature -profile	

### OPTICAL AND ELECTRICAL CHARACTERISTICS CURVES

RED 630-642NM, RED-ORANGE 620-630NM, ORANGE 600-610NM, YELLOW 590-595NM, YELLOW 583-590NM, YELLOW GREEN 570-575NM, GREEN 562-570NM

FORWARD VOLTAGE VS FORWARD CURRENT (Ta=25°C)

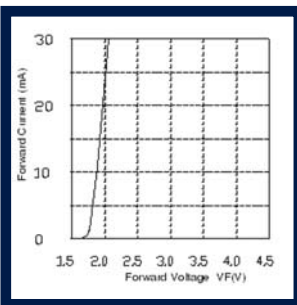

RELATIVE INTENSITY VS FORWARD CURRENT (Ta=25°C)

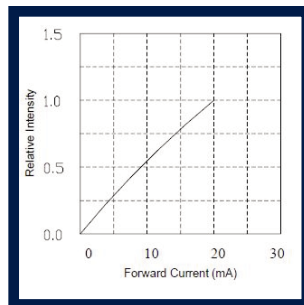

DERATING

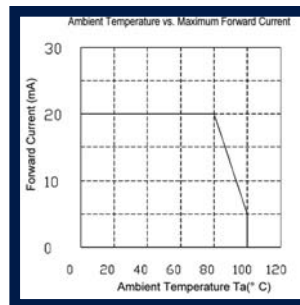

RELATIVE INTENSITY VS AMBIENT TEMPERATURE

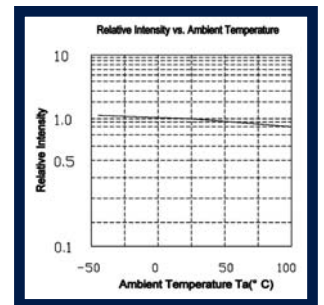

GREEN 515-525NM, BLUE 470-475NM

FORWARD VOLTAGE VS FORWARD CURRENT (Ta=25°C)

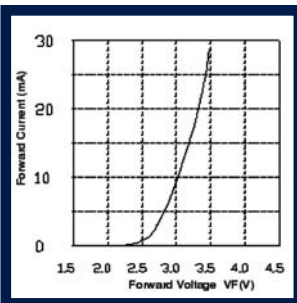

RELATIVE INTENSITY VS FORWARD CURRENT (Ta=25°C)

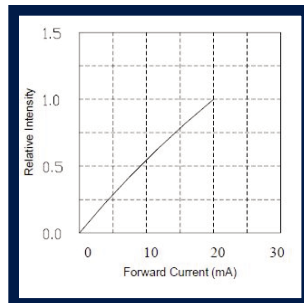

DERATING

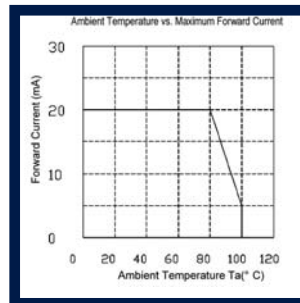

RELATIVE INTENSITY VS AMBIENT TEMPERATURE

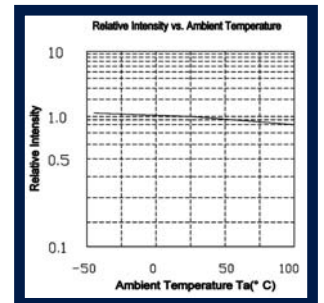

Dialight reserves the right to make changes at any time in order to supply the best product possible.

The most current version of this document will always be available at:

[http://www.dialight.com/Assets/Brochures\\_And\\_Catalogs/Indication/MDEI59801208RT117.pdf](http://www.dialight.com/Assets/Brochures_And_Catalogs/Indication/MDEI59801208RT117.pdf)

MDEI59801208RT117\_B