

HDR Series HDRA Series HDR系列 HDRA系列

0.8mm pitch interface connector
0.8mm间距 接口用连接器



Features 特点

★Compact and robust

★小型、牢固

Mating pitch; 0.8mm
嵌合部间距 采用0.8mm

★Abundant variation

★产品阵容丰富多彩

Various choices for PC board side and cable side
基板侧、电缆侧产品阵容丰富多彩

★Industrial camera standard compatible

★符合工业摄像头标准

Support camera link
对应Camera Link

★Support EMI/ESD

★支持EMI/ESD

Prevent noise with metal shell
采用金属壳体防止杂音

★High Durability

★高耐久性

Design for High Durability of 5,000 times
5,000次高耐久性计

★Support high speed transmission

★对应高速传送

LVDS signal, etc.
LVDS信号等

HDR series and HDRA series Differences!

HDR系列与HDRA系列有这些不同!

While basic specifications such as mating pitch (0.8mm) are same, the both series have the following differences.

虽然嵌合间距 (0.8mm) 等基本规格相同, 但两个系列有以下不同。

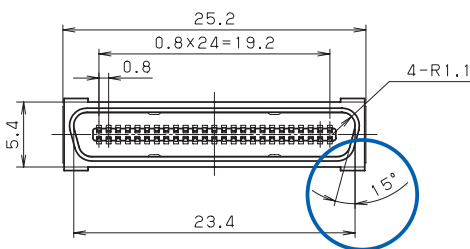
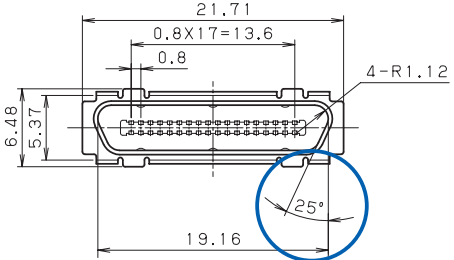
	HDR	HDRA
① Mating Position portion shape 嵌合部形状		
② Number of contacts 芯数	14、26、50	36、68、100
③ Compatible with standards 对应标准	Camera link (AIA)	SCSI-III(ANSI/SFF8441)

Specification 规格

HDRSeries HDR系列

Rated voltage 额定电压	AC 125V(r.m.s.)
Rated current 额定电流	0.5 A / Terminal 0.5A/端子
Insulated resistance 绝缘电阻	1,000 M-Ohm or more at DC 250 V 在DC 250V的条件下1000MΩ以上
Dielectric withstanding voltage 耐电压	AC 350V(r.m.s.)
Contact resistance 接触电阻	70 m-Ohm or less 70mΩ以下
Storage temperature 使用温度范围	-40 degree-C to 70 degree-C -55 degree-C to 85 degree-C (without case) -40℃至70℃ -55℃至85℃ (无外壳时)

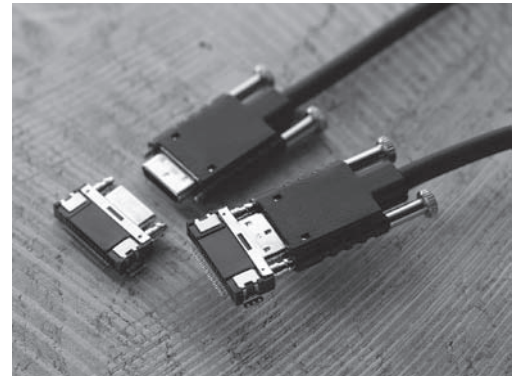

HDRASeries HDRA系列

Rated voltage 额定电压	AC 30V(r.m.s.)
Rated current 额定电流	0.3 A / Terminal 0.3A/端子
Insulated resistance 绝缘电阻	500 M-Ohm or more at DC 100 V 在DC 100V的条件下500MΩ以上
Dielectric withstanding voltage 耐电压	AC 250V(r.m.s.)
Contact resistance 接触电阻	70 m-Ohm or less 70mΩ以下
Storage temperature 使用温度范围	-40 degree-C to 70 degree-C -55 degree-C to 85 degree-C (without case) -40℃至70℃ -55℃至85℃ (无外壳时)



Applications 各种应用

Camera & image processing systems
摄像头与图像处理装置

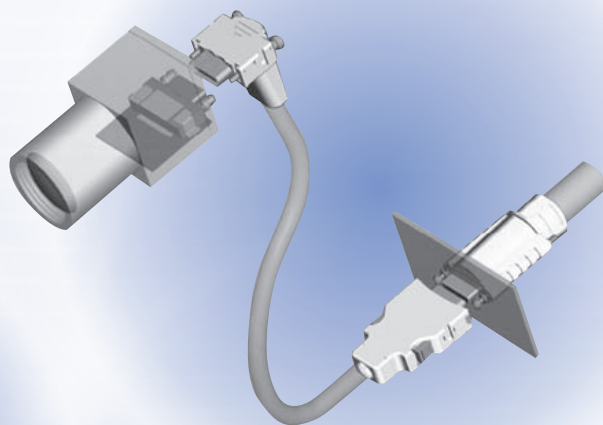

RAID / Communication devices
RAID、通信机器

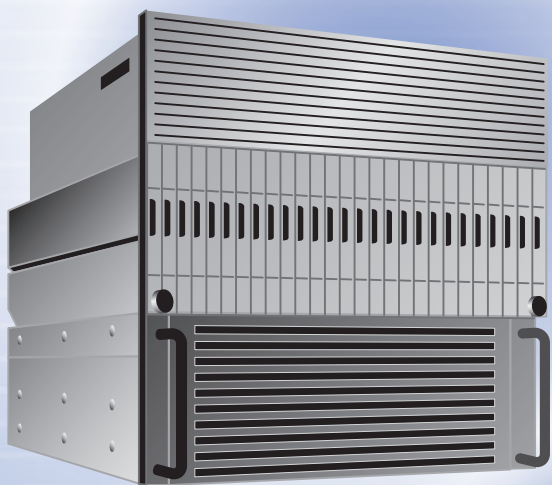

Machine tools / Robots
机床、机器人

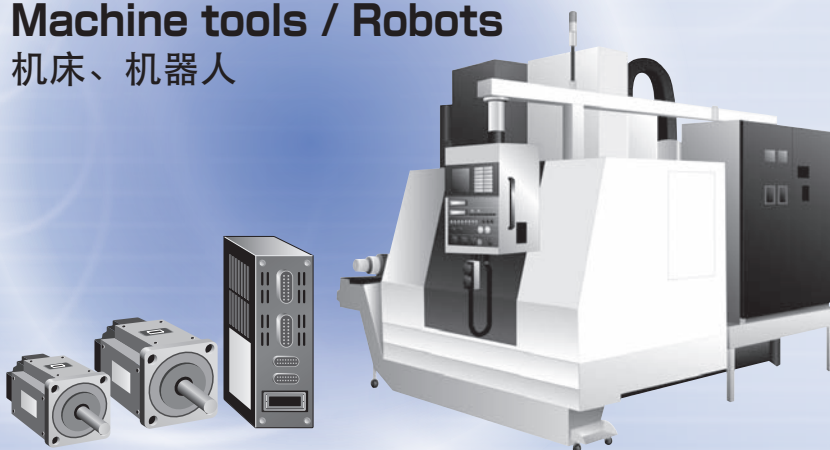

Space saving 节约空间

High design flexibility 设计自由度

High reliability 可靠性高

Measuring devices
计测机器



Office equipments
办公机器

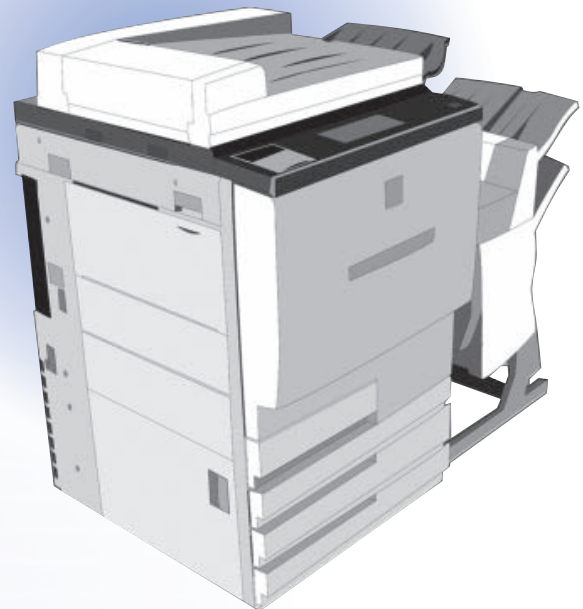

Medical equipments
医疗器械

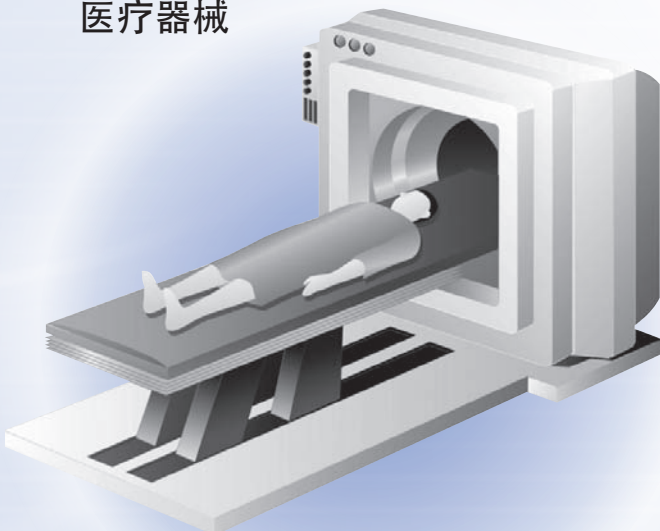

Fulfill your plans!

PC board to cable 基板与电缆的连接

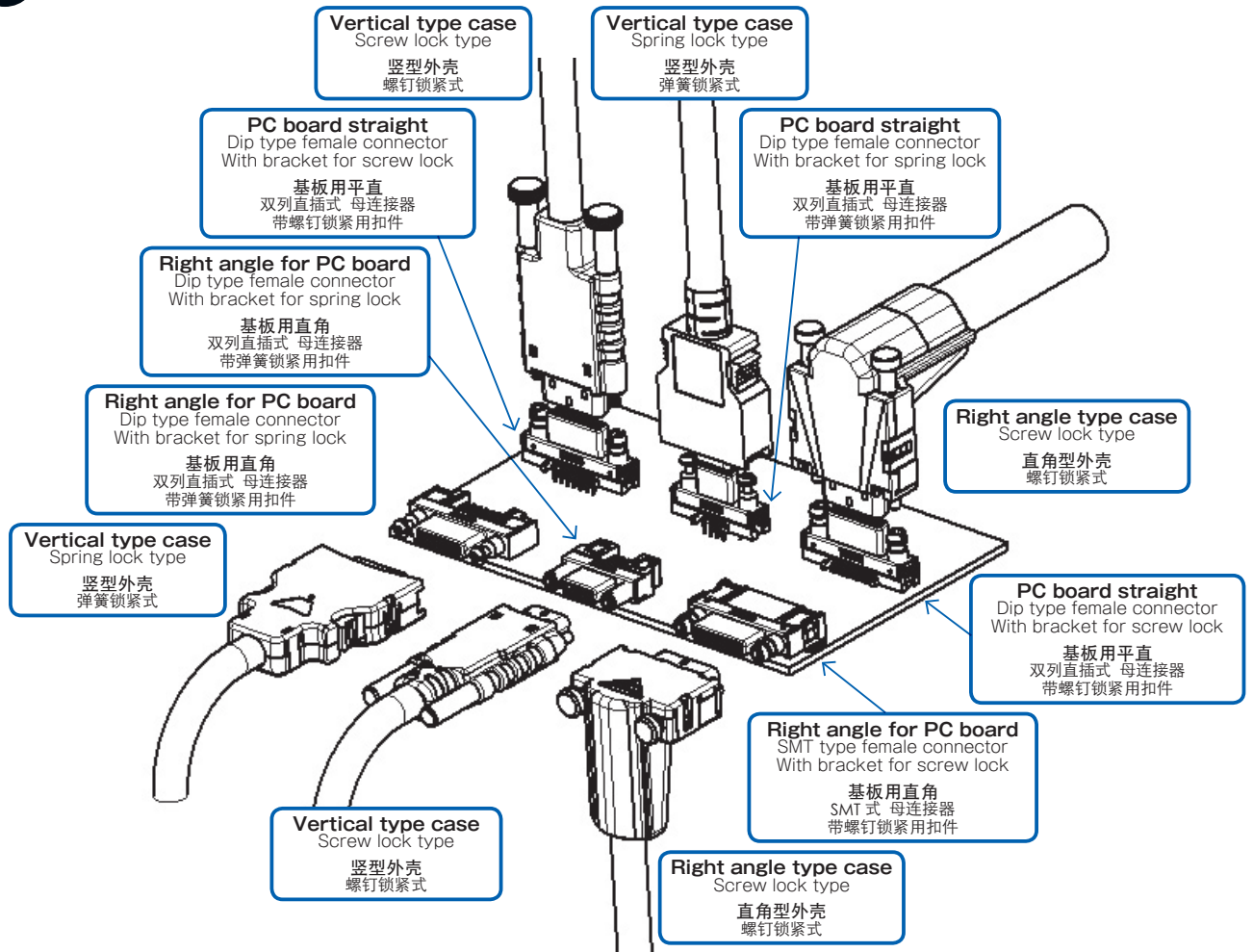

Cable to cable 电缆与电缆的连接

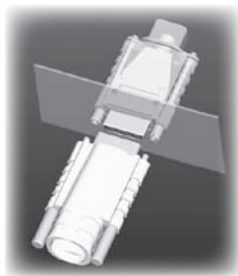

Screw lock type
螺钉锁紧式



Spring lock type
弹簧锁紧式

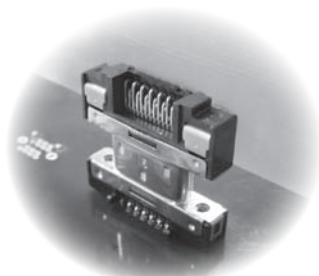

Vertical connection type
垂平连接式

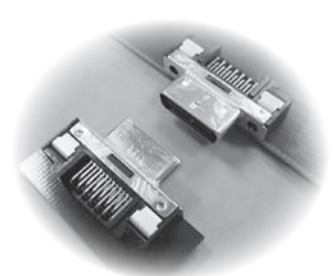

Horizontal connection type
水平连接式

For board to board 用于基板与基板的连接

满足您的方案！

1 Direction of connector on PC board side?
基板侧连接器的方向如何？

⇒ **Right angle or straight**
直角或平直

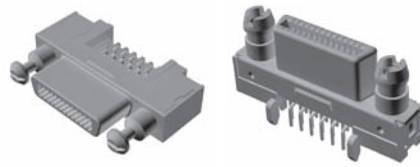

2 Mounting method of PC board side?
基板侧安装方法如何？

⇒ **Dip or SMT**
双列直插或 SMT

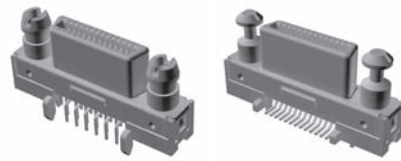

3 Locking mechanism of PC board side?
基板侧锁紧机构如何？

⇒ **Spring lock or screw lock**
弹簧锁紧或螺钉锁紧



4 Number of contacts in PC board side?
基板侧芯数多少？

⇒ **14,26,36,50,68,100**



5 Direction of cable side case?
电缆侧外壳的方向如何？

⇒ **Right angle or straight**
直角或平直



6 Locking mechanism of cable side?
电缆侧锁紧机构如何？

⇒ **Spring lock or screw lock**
弹簧锁紧或螺钉锁紧



7 Wire connection method of cable side connector?
电缆侧连接器的接线方法如何？



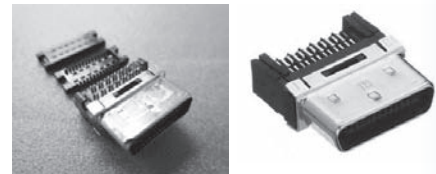



⇒ **Insulation displacement or soldering**
压接或锡焊





8 Number of contacts in cable side?
电缆侧芯数多少？

⇒ **14,26,36,50,68,100**



Type 种类	Direction 朝向	Mounting method 安装方法	Locking screw 有无锁紧螺钉	Number of contacts 芯数	Part No. 品号	
Female connector of PC board side 基板侧母连接器	Right angle 直角	Dip 双列直插 	None 无	14	HDR-EC14LFDTG2+	
				26	HDR-EC26LFDTG2+	
				50	HDR-EC50LFDTG2+	
				36	HDRA-EA36LFDT+	
				68	HDRA-EC68LFDT+	
				100	HDRA-EC100LFDT+	
		Spring lock 弹簧锁紧	14	HDR-EC14LFDTG2-SLE+		
			26	HDR-EC26LFDTG2-SLE+		
			50	HDR-EC50LFDTG2-SLE+		
			36	HDRA-EA36LFDT-SLE+		
			Screw lock 螺钉锁紧	14	HDR-EC14LFDTG2-SLD+	
				26	HDR-EC26LFDTG2-SLD+	
	50	HDR-EC50LFDTG2-SLD+				
	68	HDRA-EC68LFDT-SLD+				
	100	HDRA-EC100LFDT-SLD+				
	SMT 	None 无		14	HDR-EA14LFYPG1+	
			26	HDR-EA26LFYPG1+		
		Spring lock 弹簧锁紧	14	HDR-EA14LFYPG1-SLE+		
			26	HDR-EA26LFYPG1-SLE+		
		Screw lock 螺钉锁紧	14	HDR-EA14LFYPG1-SLD+		
			26	HDR-EA26LFYPG1-SLD+		
	68	HDRA-EA68LFZGT-SLD+				
		Straight 平直	Dip 双列直插 	None 无	14	HDR-EC14FDTG2+
					26	HDR-EC26FDTG2+
68					HDRA-EC68FDT+	
100					HDRA-EC100FDT+	
Spring lock 弹簧锁紧			14	HDR-EC14FDTG2-SLE+		
	26		HDR-EC26FDTG2-SLE+			
Screw lock 螺钉锁紧	14	HDR-EC14FDTG2-SLD+				
	26	HDR-EC26FDTG2-SLD+				
	68	HDRA-EC68FDT-SLD+				
	100	HDRA-EC100FDT-SLD+				
SMT 	None 无	14	HDR-EC14FYTG2+			
		26	HDR-EC26FYTG2+			
	Spring lock 弹簧锁紧	14	HDR-EC14FYTG2-SLE+			
		26	HDR-EC26FYTG2-SLE+			
	Screw lock 螺钉锁紧	14	HDR-EC14FYTG2-SLD+			
		26	HDR-EC26FYTG2-SLD+			
Male connector of PC board side 基板侧公连接器	Right angle 直角	SMT 	None 无	14	HDR-EA14LMYPG1+	
				26	HDR-EA26LMYPG1+	
				14	HDR-EA14LMYPG1-SLE+	
				26	HDR-EA26LMYPG1-SLE+	
		Screw lock 螺钉锁紧	14	HDR-EA14LMYPG1-SLD+		
			26	HDR-EA26LMYPG1-SLD+		
			Dip 双列直插 	None 无	26	HDR-EC26LMDTG1+
					Spring lock 弹簧锁紧	26
	Screw lock 螺钉锁紧	26			HDR-EC26LMDTG1-SLD+	

Name 名称	Locking method 锁紧方法	Applicable series 对象系列	Panel thickness (mm) 面板厚度 (mm)	Part No. 品号
Lock screw 锁紧螺钉	Spring lock 弹簧锁紧 	HDR series only HDR系列专用	0	HDR-E14LMY-SL-02H
			0.8	HDR-E14LMY-SL-02E
			1.0	HDR-E14LMY-SL-02B
			1.2	HDR-E14LMY-SL-02FA
	Screw lock 螺钉锁紧 	HDR/HDRA series common HDR/HDRA系列共用	0	HDRA-E68LFD-7C
			0.8	HDRA-E68LFD-7F
			1.0	HDRA-E68LFD-7E
		1.2	HDRA-E68LFD-7	



Name 名称	Locking method 锁紧方法	Cable outlet direction 电缆引出方向	Number of contacts 芯数	Part No. 品号	Remarks 备注	
Case for cable 电缆用外壳	For spring lock 弹簧锁紧用	Straight 平直	14	HDR-E14LPA5	For use with connectors:IDC type connectors only 适合连接器: 仅限压接式	
			26	HDR-E26LPA5	For use with connectors:IDC type connectors only 适合连接器: 仅限压接式	
			26	HDR-E26LPJ+	For use with connectors:IDC type and soldering type 适合连接器: 压接式和锡焊式	
			50	HDR-E50LPA5	For use with connectors:IDC type connectors only 适合连接器: 仅限压接式	
			36	HDRA-E36LPTH	For use with connectors:IDC type connectors only 适合连接器: 仅限压接式	
	For screw lock 螺钉锁紧用	Straight 平直	14	HDR-E14LPH	For use with connectors:IDC type and soldering type 适合连接器: 压接式和锡焊式	
			26	HDR-E26LPM+	For use with connectors:IDC type and soldering type 适合连接器: 压接式和锡焊式	
			26	HDR-E26LPH	For use with connectors:IDC type and soldering type 适合连接器: 压接式和锡焊式	
			26	HDR-E26LPK+	For thick wire; For use with connectors:IDC type and soldering type 粗线用 适合连接器: 压接式和锡焊式	
			50	HDR-E50LPH	For use with connectors:IDC type and soldering type 适合连接器: 压接式和锡焊式	
			68	HDRA-E68LGKPA	For use with connectors:IDC type connectors only 适合连接器: 仅限压接式	
			100	HDRA-E100LPA	For use with connectors:IDC type connectors only 适合连接器: 仅限压接式	
	For joint 中转用	Right angle 直角	Straight 平直	26	HDR-E26ALPA+	For use with connectors:IDC type and soldering type 适合连接器: 压接式和锡焊式
				14	HDR-E14LPHB+	For screw lock; Panel thickness: 0.8 mm 螺钉锁紧用 面板厚度: 0.8mm
				14	HDR-E14LPHC+	For screw lock; Without Panel 螺钉锁紧用 无面板
				14	HDR-E14LPHD+	For spring lock; Without Panel 弹簧锁紧用 无面板
				26	HDR-E26LPHB+	For screw lock; Panel thickness: 0.8 mm 螺钉锁紧用 面板厚度: 0.8mm
				26	HDR-E26LPHC+	For screw lock; Without Panel 螺钉锁紧用 无面板
				26	HDR-E26LPHD+	For spring lock; Without Panel 弹簧锁紧用 无面板
				26	HDR-E26LPKB+	For thick wire; For screw lock; Panel thickness: 0.8 mm 粗线用 螺钉锁紧用 面板厚度: 0.8mm
				26	HDR-E26LPKC+	For thick wire; For screw lock; Without Panel 粗线用 螺钉锁紧用 无面板
	26	HDR-E26LPKD+	For thick wire; For spring lock; Without Panel 粗线用 弹簧锁紧用 无面板			



Name 名称	Wire connection method 接线方法	Shape 形状	Number of contacts 芯数	Part No. 品号	Remarks 备注
Connector for cable 电缆用连接器	Insulation displacement type 压接式	Male 公	14	HDR-E14MAG1+	Compatible cable: AWG#30 (7/0.1) External jacket diameter: 0.58 mm or less 适合电缆: AWG#30(7/0.1)外覆直径: 0.58mm以下
			26	HDR-E26MAG1+	
			50	HDR-E50MAG1+	
			36	HDRA-E36MA+	
			68	HDRA-E68MA+	
			100	HDRA-E100MA1+	
	Soldering type 锡焊式	Male 公	14	HDR-E14MSG1+	Compatible cable: AWG#28 (7/0.127) External jacket diameter: 1.0 mm or less 适合电缆: AWG#28(7/0.127)外覆直径: 1.0mm以下
			26	HDR-E26MSG1+	
			50	HDR-E50MSG1+	
	Insulation displacement type 压接式	Female 母	14	HDR-E14FAG1+	Compatible cable: AWG#30 (7/0.1) External jacket diameter: 0.58 mm or less 适合电缆: AWG#30(7/0.1)外覆直径: 0.58mm以下
			26	HDR-E26FAG1+	
		Soldering type 锡焊式	Female 母	14	HDR-E14FSG1+
26				HDR-E26FSG1+	

Name 名称	Wire connection method 接线方法	Lock screw 锁紧螺钉	Number of contacts 芯数	Part No. 品号	Remarks 备注
Connector for panel mount 面板座用连接器	Insulation displacement type 压接式	None 无	14	HDR-EC14PFAG1+	Compatible cable: AWG#30 (7/0.1) External jacket diameter: 0.58 mm or less 适合电缆: AWG#30(7/0.1)外覆直径: 0.58mm以下
			26	HDR-EC26PFAG1+	

MEMO
记录 (記録)

A series of horizontal dotted lines for writing.

Combination of parts numbers in application example 依据使用事例的品号组合

Application example 使用事例			Connector of PC board side 基板侧连接器	Case 外壳	Connector for cable 电缆用连接器
Item 项目	Condition 条件		P/N : HDR-EC26LFDTG2-SLE+	P/N : HDR-E26LPA5	P/N : HDR-E26MAG1+
Direction of PC board 基板方向	Right angle 直角				
Mounting 安装	DIP				
Locking method 锁紧方法	Spring 弹簧				
Number of contacts 芯数	26				
Direction of case 外壳朝向	Straight 平直				
Cable connection 电缆接线	Insulation displacement 压接				
Panel 有无面板	None 无				
Item 项目	Condition 条件		P/N : HDR-EC26FDTG2-SLD+	P/N : HDR-E26LPH	P/N : HDR-E26MAG1+
Direction of PC board 基板方向		Straight 平直			
Mounting 安装	DIP				
Locking method 锁紧方法		Screw 螺钉			
Number of contacts 芯数	26				
Direction of case 外壳朝向	Straight 平直				
Cable connection 电缆接线	Insulation displacement 压接	Soldering 锡焊			
Panel 有无面板	None 无				
Item 项目	Condition 条件		P/N : HDR-EC26FDTG2+	P/N : HDR-E26ALPA+	P/N : HDR-E26MAG1+
Direction of PC board 基板方向		Straight 平直			
Mounting 安装	DIP				
Locking method 锁紧方法		Screw 螺钉			
Number of contacts 芯数	26				
Direction of case 外壳朝向		Right angle 直角			
Cable connection 电缆接线	Insulation displacement 压接	Soldering 锡焊			
Panel 有无面板		Yes 有 t=0.8mm			
Item 项目	Condition 条件		P/N : HDRA-EC68LFDT+	P/N : HDRA-E68LGKPA	P/N : HDRA-E68MA+
Direction of PC board 基板方向	Right angle 直角				
Mounting 安装	DIP				
Locking method 锁紧方法		Screw 螺钉			
Number of contacts 芯数		68			
Direction of case 外壳朝向	Straight 平直				
Cable connection 电缆接线	Insulation displacement 压接				
Panel 有无面板		Yes 有 t=1.0mm			
Item 项目	Condition 条件		P/N : HDR-EA26LFYPG1+	P/N : HDR-E26LPA5	P/N : HDR-E26MAG1+
Direction of PC board 基板方向	Right angle 直角				
Mounting 安装		SMT			
Locking method 锁紧方法	Spring 弹簧				
Number of contacts 芯数	26				
Direction of case 外壳朝向	Straight 平直				
Cable connection 电缆接线	Insulation displacement 压接				
Panel 有无面板		Yes 有 t=0.8mm			

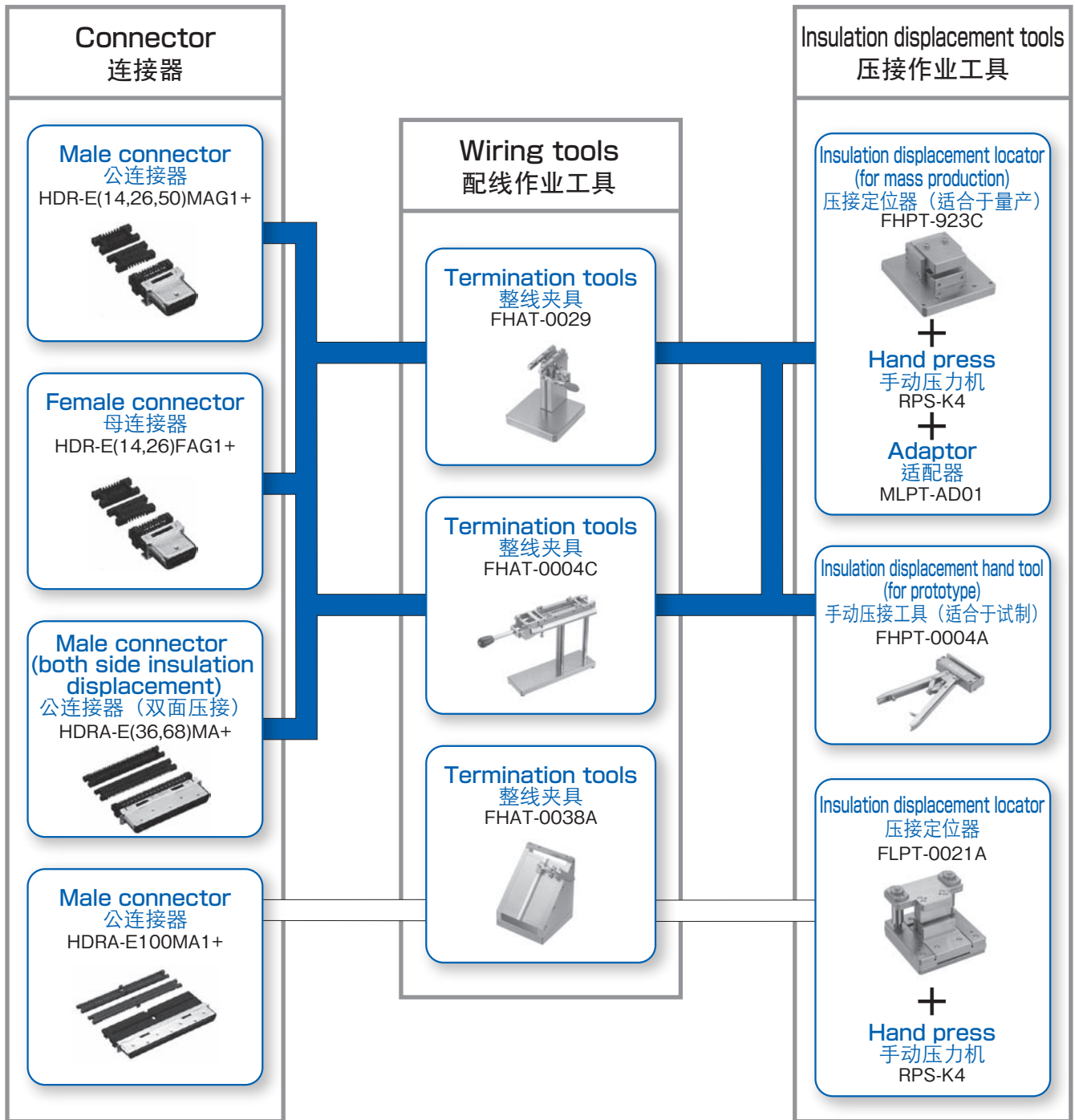

Clamp caulking tool 线卡铆接夹具		
Number of contacts 芯数	Applicable products 对象产品	Jig parts numbers 夹具品号
14 contacts 14芯	HDR-E14LPA5	FHPT-0024A
	HDR-E14LPH	MHAT-0048A
	HDR-E14LPHB+	
	HDR-E14LPHC+	
	HDR-E14LPHD+	
36 contacts 36芯	HDRA-E36LPTH	FLPT-0024A
50 contacts 50芯	HDR-E50LPA5	FHPT-0023A
	HDR-E50LPH	MHPT-0010A

Clamp caulking tool 线卡铆接夹具		
Number of contacts 芯数	Applicable products 对象产品	Jig parts numbers 夹具品号
26 contacts 26芯	HDR-E26LPA5	FHPT-0022A
	HDR-E26LPJ	
	HDR-E26LPH	MHPT-0006A
	HDR-E26LPHB+	
	HDR-E26LPHC+	
	HDR-E26LPHD+	
	HDR-E26LPK+	MLPT-0037B
	HDR-E26LPKB+	
	HDR-E26LPKC+	
	HDR-E26LPKD+	MHPT-0007A
HDR-E26LPM+		
HDR-E26ALPA+	MHPT-0012A	

Cable assembly product 电缆装配件

14 contacts 14 均

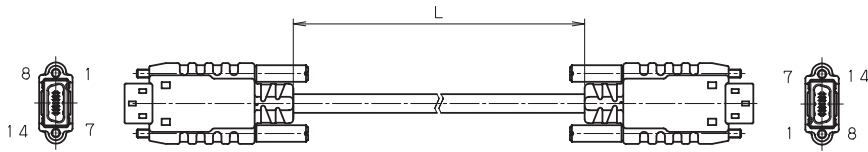

Cable length (m) 电缆长 (m)	Tolerance (mm) 公差 (mm)	Part No. 品号	Remarks 备注
1	±50	HDR-AS-0151-L100+	Connector:HDR-E14MAG1+ Case:HDR-E14LPH
3	±75	HDR-AS-0151-L300+	Cable:UL20276 7PX30AWG(7/0.102)black 连接器 : HDR-E14MAG1+
5	±125	HDR-AS-0151-L500+	壳体 : HDR-E14LPH 电缆 : UL20276 7PX30AWG (7/0.102) 黑色

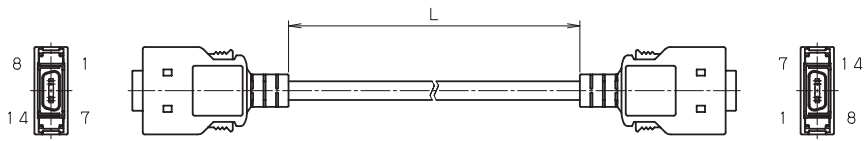

Cable length (m) 电缆长 (m)	Tolerance (mm) 公差 (mm)	Part No. 品号	Remarks 备注
1	±50	HDR-AS-0152-L100+	Connector:HDR-E14MAG1+ Case:HDR-E14LPA5
3	±75	HDR-AS-0152-L300+	Cable:UL20276 7PX30AWG(7/0.102)black 连接器 : HDR-E14MAG1+
5	±125	HDR-AS-0152-L500+	壳体 : HDR-E14LPA5 电缆 : UL20276 7PX30AWG (7/0.102) 黑色

50 contacts 50 均

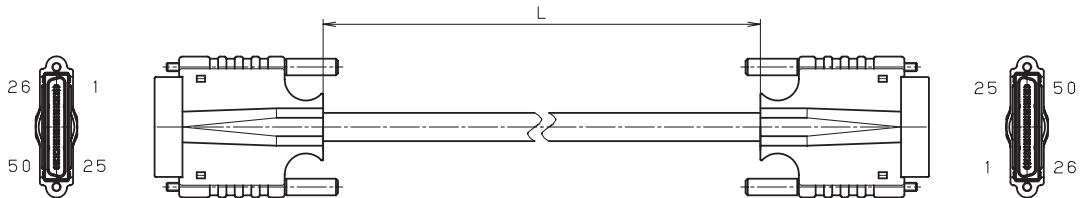

Cable length (m) 电缆长 (m)	Tolerance (mm) 公差 (mm)	Part No. 品号	Remarks 备注
1	±50	HDR-AS-0146-L100+	Connector:HDR-E50MAG1+ Case:HDR-E50LPH
3	±75	HDR-AS-0146-L300+	Cable:UL20276 25PX30AWG(7/0.102)black 连接器 : HDR-E50MAG1+
5	±125	HDR-AS-0146-L500+	壳体 : HDR-E50LPH 电缆 : UL20276 25PX30AWG (7/0.102) 黑色

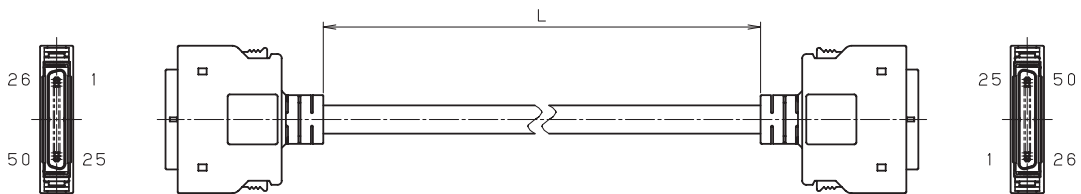

Cable length (m) 电缆长 (m)	Tolerance (mm) 公差 (mm)	Part No. 品号	Remarks 备注
1	±50	HDR-AS-0147-L100+	Connector:HDR-E50MAG1+ Case:HDR-E50LPA5
3	±75	HDR-AS-0147-L300+	Cable:UL20276 25PX30AWG(7/0.102)black 连接器 : HDR-E50MAG1+
5	±125	HDR-AS-0147-L500+	壳体 : HDR-E50LPA5 电缆 : UL20276 25PX30AWG (7/0.102) 黑色

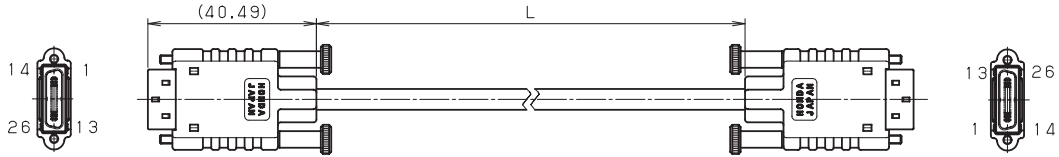

Cable length (m) 电缆长 (m)	Tolerance (mm) 公差 (mm)	Part No. 品号	Remarks 备注
1	±50	HDR-AS-0148-L100+	Connector:HDR-E26MAG1+ Case:HDR-E26LPH
3	±75	HDR-AS-0148-L300+	Cable:UL20276 13PX30AWG(7/0.102)black 连接器 : HDR-E26MAG1+
5	±125	HDR-AS-0148-L500+	壳体 : HDR-E26LPH 电缆 : UL20276 13PX30AWG (7/0.102) 黑色

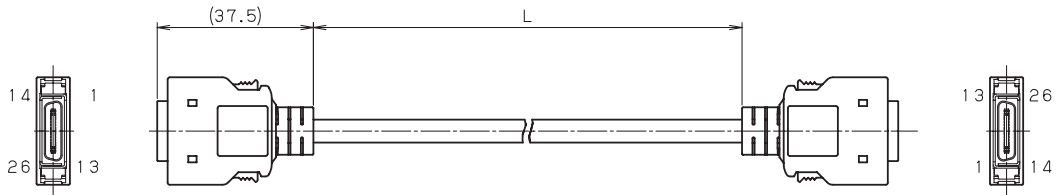

Cable length (m) 电缆长 (m)	Tolerance (mm) 公差 (mm)	Part No. 品号	Remarks 备注
1	±50	HDR-AS-0149-L100+	Connector:HDR-E26MAG1+ Case:HDR-E26LPA5
3	±75	HDR-AS-0149-L300+	Cable:UL20276 13PX30AWG(7/0.102)black 连接器 : HDR-E26MAG1+
5	±125	HDR-AS-0149-L500+	壳体 : HDR-E26LPA5 电缆 : UL20276 13PX30AWG (7/0.102) 黑色

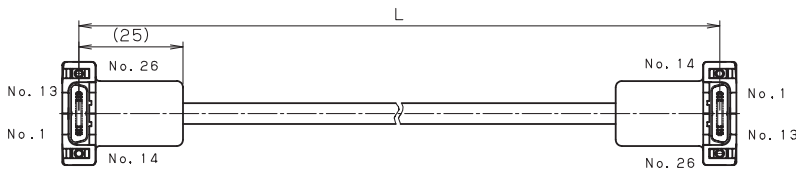

Cable length (m) 电缆长 (m)	Tolerance (mm) 公差 (mm)	Part No. 品号	Remarks 备注
1	±50	HDR-AS-0150-L100+	Connector:HDR-E26MAG1+ Case:HDR-E26ALPA+
3	±75	HDR-AS-0150-L300+	Cable:UL20276 13PX30AWG(7/0.102)black 连接器 : HDR-E26MAG1+
5	±125	HDR-AS-0150-L500+	壳体 : HDR-E26ALPA+ 电缆 : UL20276 13PX30AWG (7/0.102) 黑色

<Wiring chart> <布线表>

14 contacts 14芯

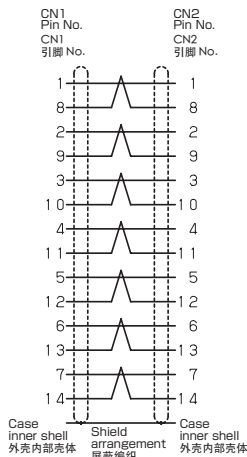

26 contacts 26芯

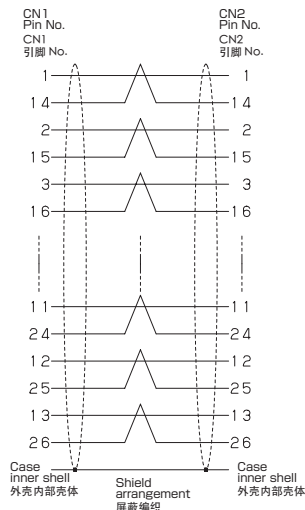

50 contacts 50芯

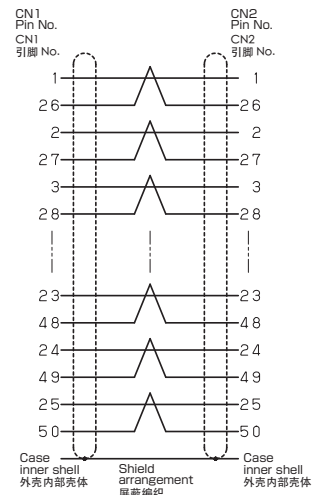

Connect To The Next



Caution 注意事项

- Minimum lot volume is set for each product for sales lot.
- Please be advised that contents of this catalog are subject to change without advanced notice for improvement, etc.
- Please contact distributors or our sales representative for details of products listed in this catalog.
- 各产品分别设有最小销售批次；
- 本产品目录所记载的内容可能因改良等而变更，恕不另行通知；
- 有关本产品目录所记载的产品详情，请咨询经销商或本公司。



- For details for products such as stocks, delivery and prices, please contact:
- 库存、交货期、价格等与产品相关的咨询

本多通信工業株式会社

<http://www.honda-connectors.co.jp/>

Contents of this catalog are based on the information as of October, 2012.
本产品目录所记载的内容为2012年10月时点的情况。