

# FLLD3 – MH, 530/305 VAC, 7 –180 A

## High Performance Chassis Mount Three-Phase Filters

### Overview

The three-phase filters are general-purpose, compact and slim, with terminal blocks for quick installation in industrial equipment. They are optimized in geometry, with high insertion-loss characteristics.

### Applications

Typical applications include switch-mode power supplies, servo drives, robotics, regenerative drives, battery chargers, inverters, converters, power drives, UPS machines, process automation and other industrial applications.



### Technical Specifications

Item	Parameters/ Characteristics
Rated Voltage	530/305 VAC
Rated Frequency	50 – 60 Hz
Rated Current	7 – 180 A
Rated Temperature	50°C
Temperature Range	-25°C to 100°C
Climate Category	25/100/21
Voltage Test	P → P 2,250 VDC P → E 3,000 VDC

Typical Electrical Schematic

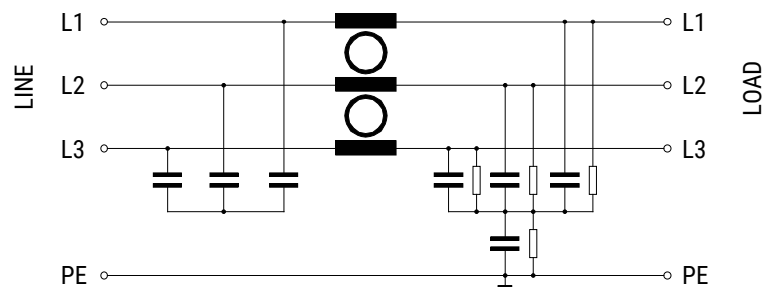



## Technical Specifications cont'd

Part Number	Rated Current at 50°C (A)	Power Loss at 25°C/50 Hz (W)	Leakage Current <sup>1</sup> (mA)	Approximate Weight (kg)
FLLD3007AMHT3	7	4	3.1	0.5
FLLD3016AMHT3	16	6	3.1	0.7
FLLD3030AMHT3	30	12	4.7	1.1
FLLD3042AMHT3	42	15	4.7	1.4
FLLD3055AMHT5	55	20	4.7	2.0
FLLD3075AMHT5	75	30	4.7	3.2
FLLD3100AMHT6	100	32	4.7	4.5
FLLD3130AMHT6	130	40	4.7	4.5
FLLD3180AMHT7	180	45	4.7	5.1

<sup>1</sup> Calculated according to IEC 60939. During fail conditions the current may be higher.

## Approvals

Standard	Certification Body	File Number	Mark
IEC/EN 60939-3	UL-Demko		
ANSI/UL 60939-3-2016	UL	E490803	

## Environmental Compliance

KEMET EMI filters are RoHS Compliant.



RoHS Compliant

## Typical Insertion Loss

7 to 30 A

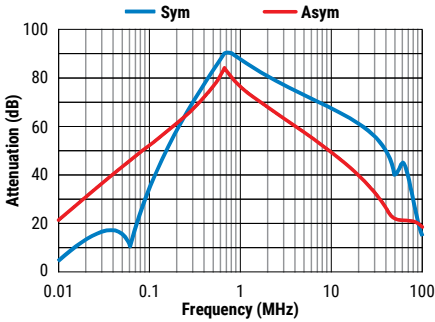

42 and 100 A

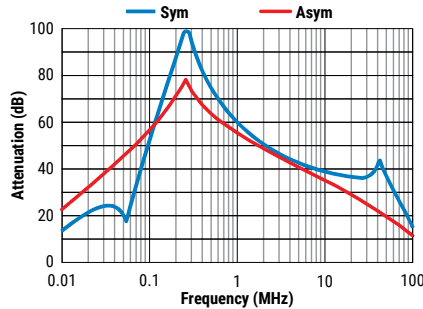

130 and 180 A

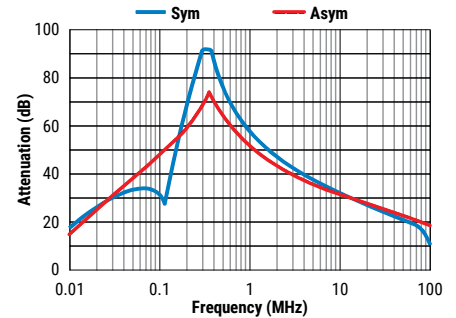

## Mechanical Dimensions – Millimeters

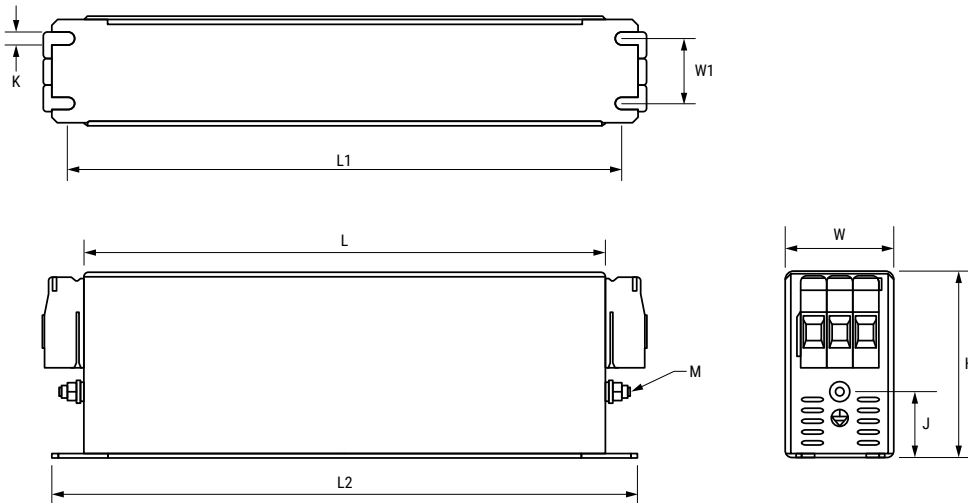

Part Number	Dimensions									Terminal Block	
	L	L1	L2	W	W1	H	J	K	M	Wire (mm <sup>2</sup> )	Torque (Nm)
	FLLD3007AMHT3	160	180	190	40	20	70	22	4.5	M5	1 – 10
FLLD3016AMHT3	220	235	250	45	25	70	22	5.5	M5	1 – 10	1.2 – 1.5
FLLD3030AMHT3	240	255	270	50	30	85	30	5.5	M5	1 – 10	1.2 – 1.5
FLLD3042AMHT3	280	295	310	50	30	85	30	5.5	M6	1 – 10	1.2 – 1.5
FLLD3055AMHT5	220	235	250	85	60	90	26	5.5	M6	10 – 25	3 – 4
FLLD3075AMHT5	240	255	270	80	60	135	70	6.5	M6	10 – 25	3 – 4
FLLD3100AMHT6	240	255	270	90	65	150	64	6.5	M10	16 – 50	6 – 8
FLLD3130AMHT6	240	255	270	90	65	150	64	6.5	M10	16 – 50	6 – 8
FLLD3180AMHT7	350	365	380	120	102	170	47	6.5	M10	35 – 95	15 – 20

Tolerances, if not stated, according to ISO 2768-c.

## KEMET Electronics Corporation Sales Offices

For a complete list of our global sales offices, please visit [www.kemet.com/sales](http://www.kemet.com/sales).

---

### Disclaimer

All product specifications, statements, information and data (collectively, the "Information") in this datasheet are subject to change. The customer is responsible for checking and verifying the extent to which the Information contained in this publication is applicable to an order at the time the order is placed.

All Information given herein is believed to be accurate and reliable, but it is presented without guarantee, warranty, or responsibility of any kind, expressed or implied.

Statements of suitability for certain applications are based on KEMET Electronics Corporation's ("KEMET") knowledge of typical operating conditions for such applications, but are not intended to constitute – and KEMET specifically disclaims – any warranty concerning suitability for a specific customer application or use. The Information is intended for use only by customers who have the requisite experience and capability to determine the correct products for their application. Any technical advice inferred from this Information or otherwise provided by KEMET with reference to the use of KEMET's products is given gratis, and KEMET assumes no obligation or liability for the advice given or results obtained.

Although KEMET designs and manufactures its products to the most stringent quality and safety standards, given the current state of the art, isolated component failures may still occur. Accordingly, customer applications which require a high degree of reliability or safety should employ suitable designs or other safeguards (such as installation of protective circuitry or redundancies) in order to ensure that the failure of an electrical component does not result in a risk of personal injury or property damage.

Although all product-related warnings, cautions and notes must be observed, the customer should not assume that all safety measures are indicated or that other measures may not be required.

*KEMET is a registered trademark of KEMET Electronics Corporation.*