

P409, Integrated Resistor, Metallized Impregnated Paper, Class X2, 275 VAC

Overview

The P409 is constructed of multilayer metallized paper encapsulated and impregnated in self-extinguishing material meeting the requirements of UL 94 V-0.

Applications

Typical applications include worldwide use in contact protection, contact interference suppression and transient suppression.

Benefits

- Approvals: ENEC, UL, cUL
- Rated voltage: 275 VAC 50/60 Hz
- Capacitance range: 0.047 – 0.47 μ F
- Capacitance tolerance: \pm 20%
- Resistance range: 22 – 470 Ω
- Resistance tolerance: \pm 30%
- Lead spacing: 15.2 – 25.4 mm
- Climatic category: 40/085/56/B, IEC 60068-1
- Tape and reel packaging in accordance with IEC 60286-2
- RoHS Compliant and lead-free terminations
- Operating temperature range of -40°C to $+85^{\circ}\text{C}$
- Excellent self-healing properties which ensure long life even when subjected to frequent over voltages
- Good resistance to ionization due to impregnated paper dielectric
- High dV/dt capability
- Impregnated paper ensures excellent stability and reliability properties, particularly in applications with continuous operation



Part Number System

P	409	Q	M	473	M	275	A	H470
Capacitor Class	Series	Lead Spacing (mm)	Size Code	Capacitance Code (pF)	Capacitance Tolerance	Rated Voltage (VAC)	Packaging	Resistance (Ω)
P = Metallized Paper	RC Snubber	Q = 15.2 C = 20.3 E = 25.4	See Dimension Table	First two digits represent significant figures. Third digit specifies number of zeros.	M = \pm 20%	275 = 275	See Ordering Options Table	H plus first two digits represent significant figures. Third digit specifies number of zeros.

Ordering Options Table

Lead Spacing Nominal (mm)	Type of Leads and Packaging	Lead Length (mm)	Part Number (Insert at 14th character)
15.2	Standard Lead and Packaging Options		
	Bulk – Short Leads	6 +0/-1	C
	Bulk – Maximum Length Leads	30 +5/-0	A
	Tape & Reel (Standard Reel)	$H_0 = 18.5 \pm 0.5$	L
	Other Lead and Packaging Options		
	Tape & Reel (Large Reel)	$H_0 = 18.5 \pm 0.5$	P
20.3	Standard Lead and Packaging Options		
	Tray – Short Leads	6 +0/-1	C
	Bulk – Maximum Length Leads	30 +5/-0	A
	Tape & Reel (Standard Reel)	$H_0 = 18.5 \pm 0.5$	L
	Other Lead and Packaging Options		
	Tape & Reel (Large Reel)	$H_0 = 18.5 \pm 0.5$	P
25.4	Standard Lead and Packaging Options		
	Bulk – Short Leads	6 +0/-1	C
	Bulk – Maximum Length Leads	30 +5/-0	A

Dimensions – Millimeters

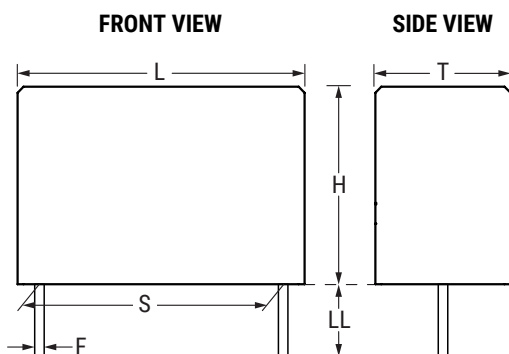

Size Code	S		T		H		L		F	
	Nominal	Tolerance	Nominal	Tolerance	Nominal	Tolerance	Nominal	Tolerance	Nominal	Tolerance
QM	15.2	± 0.4	7.3	Maximum	13.0	Maximum	18.5	Maximum	0.8	± 0.05
CE	20.3	± 0.4	7.6	Maximum	14.0	Maximum	24.0	Maximum	0.8	± 0.05
CP	20.3	± 0.4	11.3	Maximum	16.5	Maximum	24.0	Maximum	0.8	± 0.05
EJ	25.4	± 0.4	12.1	Maximum	19.0	Maximum	30.5	Maximum	1.0	± 0.05
EL	25.4	± 0.4	15.3	Maximum	22.0	Maximum	30.5	Maximum	1.0	± 0.05

Note: See Ordering Options Table for lead length (LL) options.



Performance Characteristics

Rated Voltage	275 VAC 50/60 Hz	
Capacitance Range	0.047 – 0.47 μ F	
Capacitance Tolerance	\pm 20%	
Resistance Range	22 – 470 Ω	
Resistance Tolerance	\pm 30%	
Temperature Range	-40°C to +85°C	
Climatic Category	40/085/56/B	
Approvals	ENEC, UL, cUL	
Peak Pulse Voltage	1,000 V	
Series Resistance	The series resistance is defined at 1 kHz for RC \geq 50 μ s and at 100 kHz for RC < 50 μ s	
Insulation Resistance	Minimum Values Between Terminals	
	C \leq 0.33 μ F	\geq 3,000 M Ω
	C > 0.33 μ F	\geq 1,000 M Ω \cdot μ F
Pulse Current	Maximum 12 A repetitive. Maximum 20 A peak for occasional transients.	
Test Voltage Between Terminals	The 100% screening factory test is carried out at 1,800 VDC. The voltage level is selected to meet the requirements in applicable equipment standards. All electrical characteristics are checked after the test.	
In DC Applications	Recommended voltage \leq 630 VDC	
Power Ratings	The average losses may reach 0.5 W provided the surface temperature does not exceed + 85°C. For maximum permitted power dissipation vs. temperature, see Derating Curves.	
Derating Curves	Maximum Allowable Power Dissipation vs. Ambient Temperature and Case Sizes.	
	Curve	Dimension B (mm)
	1	7.3
	2	7.6
3	11.3	
4	15.3	

Environmental Test Data

Test	IEC Publication	Procedure
Endurance	IEC 60384-14	1.25 x V _R Vac 50Hz, once every hour increase to 1,000 Vac for 0.1 second, 1,000 hours at upper rated temperature.
Vibration	IEC 60068-2-6 Test Fc	3 directions at 2 hours each, 10 – 500 Hz at 0.75 mm or 98 m/s ²
Bump	IEC 60068-2-29 Test Eb	4,000 bumps at 390 m/s ²
Change of Temperature	IEC 60068-2-14 Test Na	Upper and lower temperature 5 cycles
Active Flammability	IEC 60384-14	V _R + 20 surge pulses at 2.5 kV (pulse every 5 seconds)
Passive Flammability	IEC 60384-14	IEC 60384-1, IEC 60695-11-5 Needle-flame test
Damp Heat Steady State	IEC 60068-2-78 Test Cab	+40°C and 93% RH, 56 days

Approvals

Certification Body	Mark	Specification	File Number
Intertek Semko AB		EN/IEC 60384-14	SE/0140-33A
UL		UL 60384-14 CAN/CSA-E60384-14-09	E73869

Environmental Compliance

All KEMET EMI capacitors are RoHS Compliant.



Table 1 – Ratings & Part Number Reference

Lead Spacing (S)	Capacitance Value (µF)	Resistance (Ω)	Maximum Dimensions in mm			KEMET Part Number
			T	H	L	
15.2	0.047	47	7.3	13.0	18.5	P409QM473M275(1)H470
15.2	0.047	100	7.3	13.0	18.5	P409QM473M275(1)H101
20.3	0.1	22	7.6	14.0	24.0	P409CE104M275(1)H220
20.3	0.1	33	7.6	14.0	24.0	P409CE104M275(1)H330
20.3	0.1	47	7.6	14.0	24.0	P409CE104M275(1)H470
20.3	0.1	68	7.6	14.0	24.0	P409CE104M275(1)H680
20.3	0.1	100	7.6	14.0	24.0	P409CE104M275(1)H101
20.3	0.1	150	11.3	16.5	24.0	P409CP104M275(1)H151
20.3	0.1	220	11.3	16.5	24.0	P409CP104M275(1)H221
20.3	0.1	330	11.3	16.5	24.0	P409CP104M275(1)H331
20.3	0.1	470	11.3	16.5	24.0	P409CP104M275(1)H471
20.3	0.22	22	11.3	16.5	24.0	P409CP224M275(1)H220
20.3	0.22	33	11.3	16.5	24.0	P409CP224M275(1)H330
20.3	0.22	47	11.3	16.5	24.0	P409CP224M275(1)H470
20.3	0.22	68	11.3	16.5	24.0	P409CP224M275(1)H680
20.3	0.22	100	11.3	16.5	24.0	P409CP224M275(1)H101
20.3	0.22	150	11.3	16.5	24.0	P409CP224M275(1)H151
20.3	0.22	220	11.3	16.5	24.0	P409CP224M275(1)H221
25.4	0.22	330	12.1	19.0	30.5	P409EJ224M275(1)H331
25.4	0.22	470	15.3	22.0	30.5	P409EL224M275(1)H471
25.4	0.47	33	15.3	22.0	30.5	P409EL474M275(1)H330
25.4	0.47	47	15.3	22.0	30.5	P409EL474M275(1)H470
25.4	0.47	68	15.3	22.0	30.5	P409EL474M275(1)H680
25.4	0.47	100	15.3	22.0	30.5	P409EL474M275(1)H101
25.4	0.47	150	15.3	22.0	30.5	P409EL474M275(1)H151
25.4	0.47	220	15.3	22.0	30.5	P409EL474M275(1)H221
Lead Spacing (S)	Capacitance Value (µF)	Resistance Ω	T (mm)	H (mm)	L (mm)	KEMET Part Number

(1) Insert lead and packaging code. See Ordering Options Table for available options.

Soldering Process

The implementation of the RoHS directive has resulted in the selection of SnAgCu (SAC) alloys or SnCu alloys as primary solder. This has increased the liquidus temperature from that of 183°C for SnPb eutectic alloy to 217 – 221°C for the new alloys. As a result, the heat stress to the components, even in wave soldering, has increased considerably due to higher pre-heat and wave temperatures. Polypropylene capacitors are especially sensitive to heat (the melting point of polypropylene is 160 – 170°C). Wave soldering can be destructive, especially for mechanically small polypropylene capacitors (with lead spacing of 5 mm to 15 mm), and great care has to be taken during soldering. The recommended solder profiles from KEMET should be used. Please consult KEMET with any questions. In general, the wave soldering curve from IEC Publication 61760–1 Edition 2 serves as a solid guideline for successful soldering. Please see Figure 1.

Reflow soldering is not recommended for through-hole film capacitors. Exposing capacitors to a soldering profile in excess of the above the recommended limits may result to degradation or permanent damage to the capacitors.

Do not place the polypropylene capacitor through an adhesive curing oven to cure resin for surface mount components. Insert through-hole parts after the curing of surface mount parts. Consult KEMET to discuss the actual temperature profile in the oven, if through-hole components must pass through the adhesive curing process. A maximum two soldering cycles is recommended. Please allow time for the capacitor surface temperature to return to a normal temperature before the second soldering cycle.

Manual Soldering Recommendations

Following is the recommendation for manual soldering with a soldering iron.

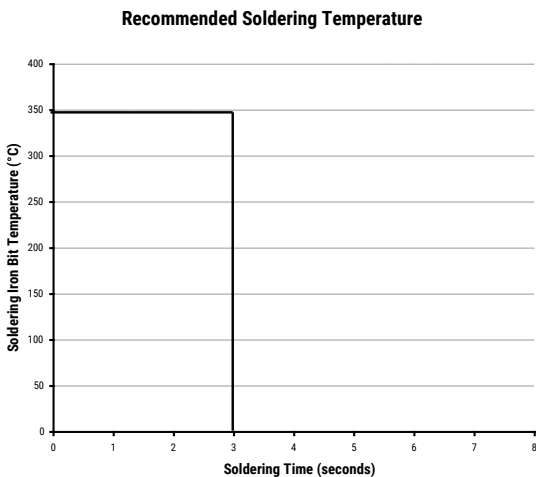

The soldering iron tip temperature should be set at 350°C (+10°C maximum) with the soldering duration not to exceed more than 3 seconds.

Wave Soldering Recommendations

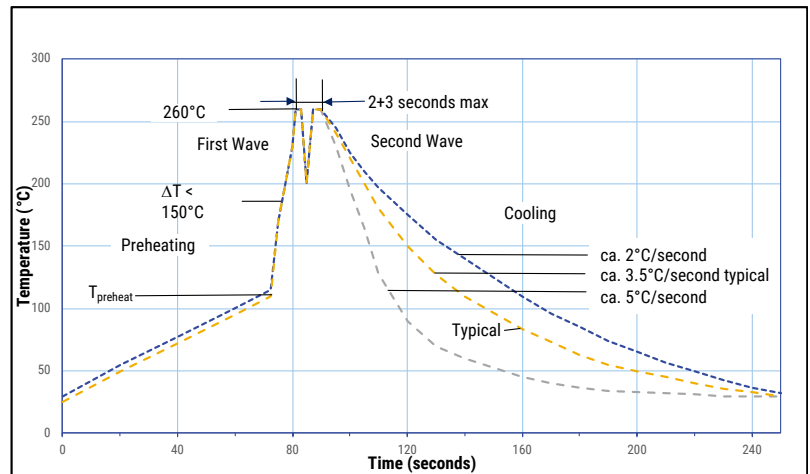

Soldering Process cont.

Wave Soldering Recommendations cont.

1. The table indicates the maximum set-up temperature of the soldering process
Figure 1

Dielectric Film Material	Maximum Preheat Temperature		Maximum Peak Soldering Temperature	
	Capacitor Pitch ≥ 10 mm	Capacitor Pitch > 15 mm	Capacitor Pitch ≤ 15 mm	Capacitor Pitch > 15 mm
Polyester	130°C	130°C	270°C	270°C
Polypropylene	110°C	130°C	260°C	270°C
Paper	130°C	140°C	270°C	270°C
Polyphenylene Sulphide	150°C	160°C	270°C	270°C

2. The maximum temperature measured inside the capacitor:

Set the temperature so that inside the element the maximum temperature is below the limit:

Dielectric Film Material	Maximum temperature measured inside the element
Polyester	160°C
Polypropylene	110°C
Paper	160°C
Polyphenylene Sulphide	160°C

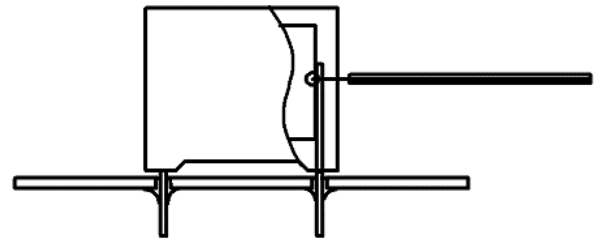

Temperature monitored inside the capacitor.

Selective Soldering Recommendations

Selective dip soldering is a variation of reflow soldering. In this method, the printed circuit board with through-hole components to be soldered is preheated and transported over the solder bath as in normal flow soldering without touching the solder. When the board is over the bath, it is stopped and pre-designed solder pots are lifted from the bath with molten solder only at the places of the selected components, and pressed against the lower surface of the board to solder the components.

The temperature profile for selective soldering is similar to the double wave flow soldering outlined in this document, **however, instead of two baths, there is only one bath with a time from 3 to 10 seconds.** In selective soldering, the risk of overheating is greater than in double wave flow soldering, and great care must be taken so that the parts are not overheated.

Construction

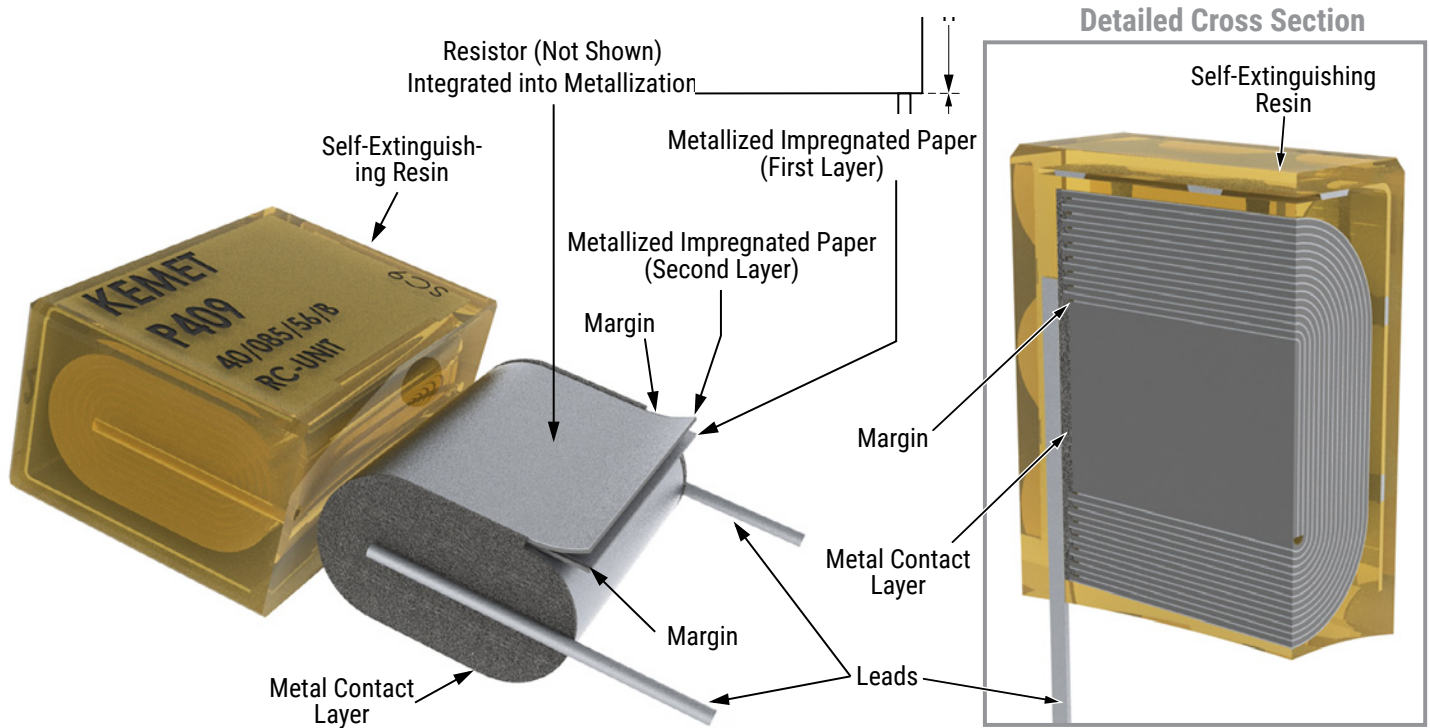

Winding Scheme

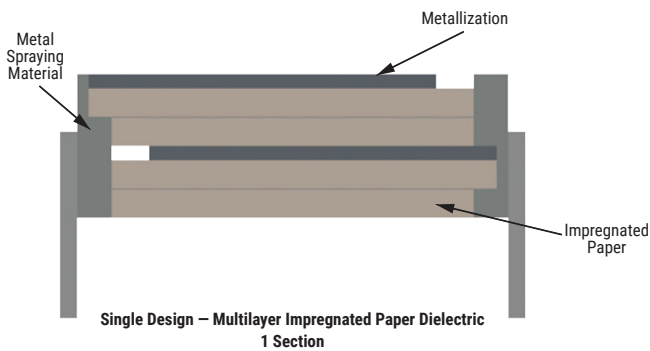

Mounting

RC units are mounted in parallel with the contacts to be protected or in parallel with the inductive load (Fig. 1 and Fig. 2). RC units are generally mounted in parallel with the contacts to suppress radio interferences (Fig. 1).

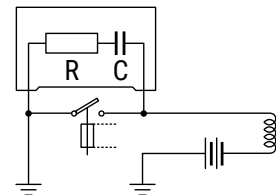

Fig. 1

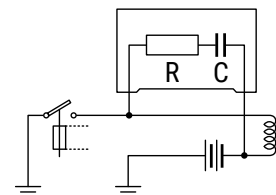
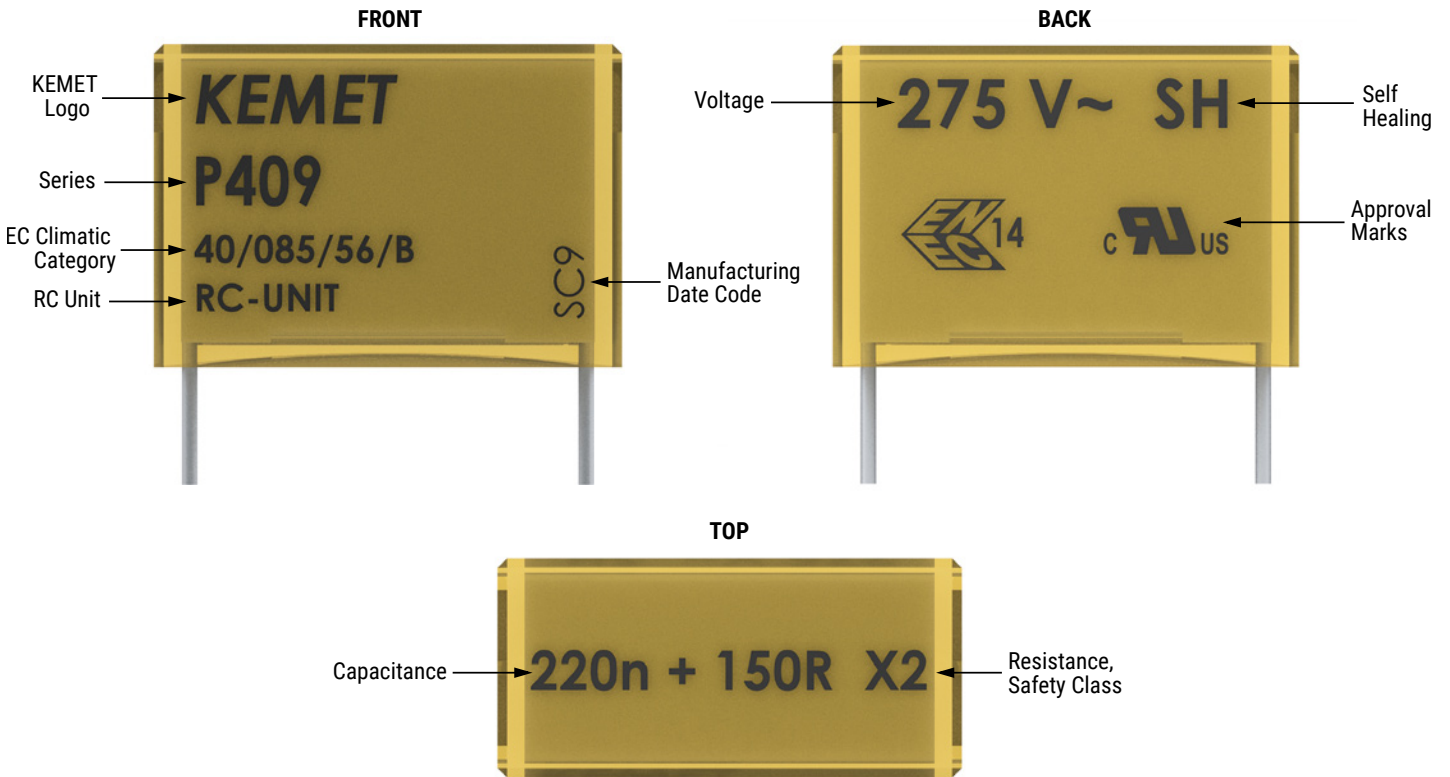

Fig. 2

Marking



Packaging Quantities

Lead Spacing (mm)	Thickness (mm)	Height (mm)	Length (mm)	Bulk Short Leads	Bulk Long Leads	Standard Reel ø 360 mm
Lead and Packaging Code				C	A	L
15.2	7.3	13.0	18.5	600	400	400
20.3	7.6	14.0	24.0	1530	250	250
	11.3	16.5	24.0	1080	150	180
25.4	12.1	19.0	30.5	864	100	
	15.3	22.0	30.5	648	75	

Lead Taping & Packaging (IEC 60286-2)

Lead Spacing 10.2 – 15.2 mm

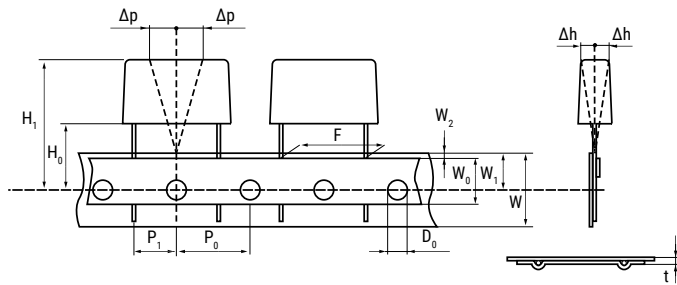

Lead Spacing 20.3 – 22.5 mm

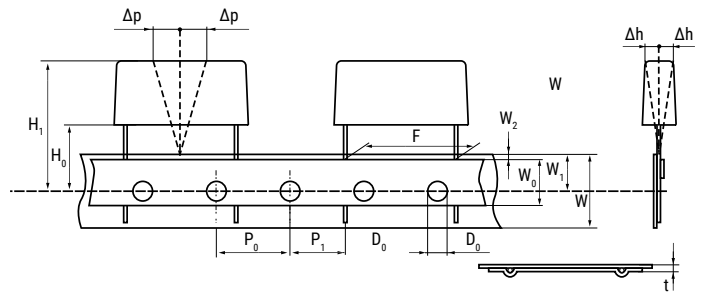

Formed Leads from 10.2 – 7.5 mm



Taping Specification

Dimensions in mm										Standard IEC 60286-2
Lead Spacing	+0.6/-0.1	F	5	7.5	Formed 7.5	10	15	22.5	27.5	F
Carrier Tape Width	±0.5	W	18	18	18	18	18	18	18	18 +1/-0.5
Hold-Down Tape Width	Minimum	W ₀	5	5	5	5	5	5	5	
Position of Sprocket Hole	±0.5	W ₁	9	9	9	9	9	9	9	9 +0.75/-0.5
Distance Between Tapes	Maximum	W ₂	3	3	3	3	3	3	3	3.0
Sprocket Hole Diameter	±0.2	D ₀	4	4	4	4	4	4	4	4.0
Feed Hole Lead Spacing	±0.3	P ₀ ⁽¹⁾	12.7	12.7	12.7(4)	12.7	12.7	12.7	12.7	12.7
Distance Lead – Feed Hole	±0.7	P ₁	3.85	3.75	3.75	7.7	5.2	5.3	5.3	P ¹
Deviation Tape – Plane	Maximum	Δp	1.3	1.3	1.3	1.3	1.3	1.3	1.3	1.3
Lateral Deviation	Maximum	Δh	2	2	2	2	2	2	2	2.0
Total Thickness	±0.2	t	0.7	0.7	0.7	0.7	0.7	0.9 Maximum	0.9 Maximum	0.9 Maximum
Sprocket Hole/Cap Body	Nominal	H ₀ ⁽²⁾	18.5±0.5	18.5±0.5	18.5±0.5	18.5±0.5	18.5±0.5	18.5±0.5	18.5±0.5	18 +2/-0
Sprocket Hole/Top of Cap Body	Maximum	H ₁ ⁽³⁾	32	31	43	43	43	58	58	58 Maximum

(1) Maximum cumulative feed hole error, 1 mm per 20 parts
(2) 16.5 mm available on request

(3) Depending on case size
(4) 15 mm available on request

Lead Taping & Packaging (IEC 60286–2) cont.

Ammo Specifications

Series	Dimensions (mm)		
	H	W	T
P409	330	330	50



Reel Specifications

Series	Dimensions (mm)		
	D	H	W
P409	360 500	30	46 (Max)

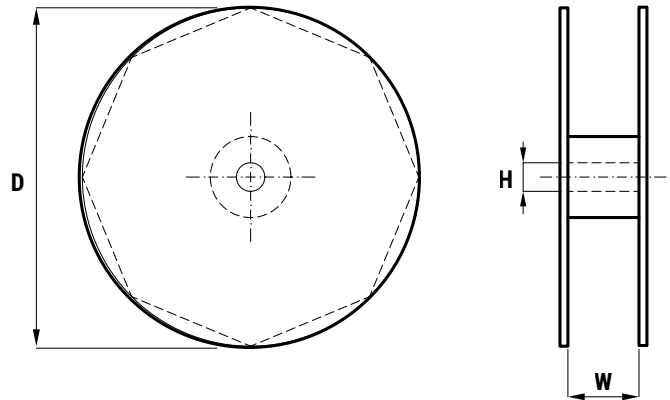

Manufacturing Date Code (IEC–60062)

Y = Year, Z = Month			
Year	Code	Month	Code
2000	M	January	1
2001	N	February	2
2002	P	March	3
2003	R	April	4
2004	S	May	5
2005	T	June	6
2006	U	July	7
2007	V	August	8
2008	W	September	9
2009	X	October	0
2010	A	November	N
2011	B	December	D
2012	C		
2013	D		
2014	E		
2015	F		
2016	H		
2017	J		
2018	K		
2019	L		
2020	M		

KEMET Electronics Corporation Sales Offices

For a complete list of our global sales offices, please visit www.kemet.com/sales.

Disclaimer

All product specifications, statements, information and data (collectively, the "Information") in this datasheet are subject to change. The customer is responsible for checking and verifying the extent to which the Information contained in this publication is applicable to an order at the time the order is placed. All Information given herein is believed to be accurate and reliable, but it is presented without guarantee, warranty, or responsibility of any kind, expressed or implied.

Statements of suitability for certain applications are based on KEMET Electronics Corporation's ("KEMET") knowledge of typical operating conditions for such applications, but are not intended to constitute – and KEMET specifically disclaims – any warranty concerning suitability for a specific customer application or use. The Information is intended for use only by customers who have the requisite experience and capability to determine the correct products for their application. Any technical advice inferred from this Information or otherwise provided by KEMET with reference to the use of KEMET's products is given gratis, and KEMET assumes no obligation or liability for the advice given or results obtained.

Although KEMET designs and manufactures its products to the most stringent quality and safety standards, given the current state of the art, isolated component failures may still occur. Accordingly, customer applications which require a high degree of reliability or safety should employ suitable designs or other safeguards (such as installation of protective circuitry or redundancies) in order to ensure that the failure of an electrical component does not result in a risk of personal injury or property damage.

Although all product-related warnings, cautions and notes must be observed, the customer should not assume that all safety measures are indicated or that other measures may not be required.

KEMET is a registered trademark of KEMET Electronics Corporation.