

THIS DOCUMENT IS SUBJECT TO CHANGE WITHOUT NOTICE. IT IS CONFIDENTIAL AND A PROPERTY OF AMPHENOL LTW. DISCLOSURE TO THIRD PARTY HAS TO BE AUTHORIZED BY AMPHENOL LTW.

REV.	ECN NO.	DATE	SIGN	DESCRIPTION
A		2016/11/03	Victor Hung	Change Rev.01 To Rev.A

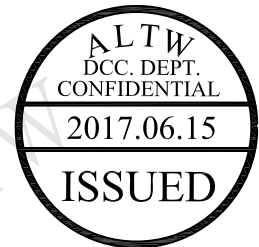
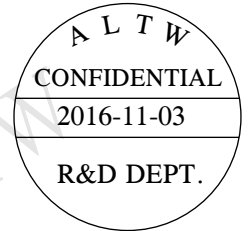
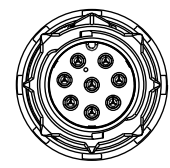
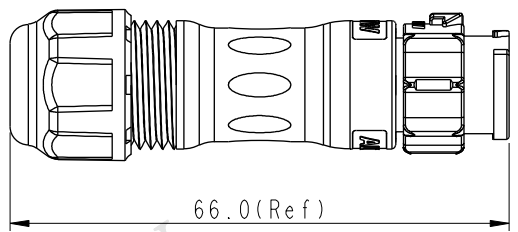
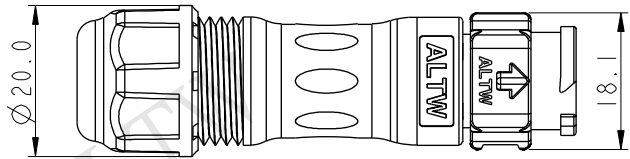
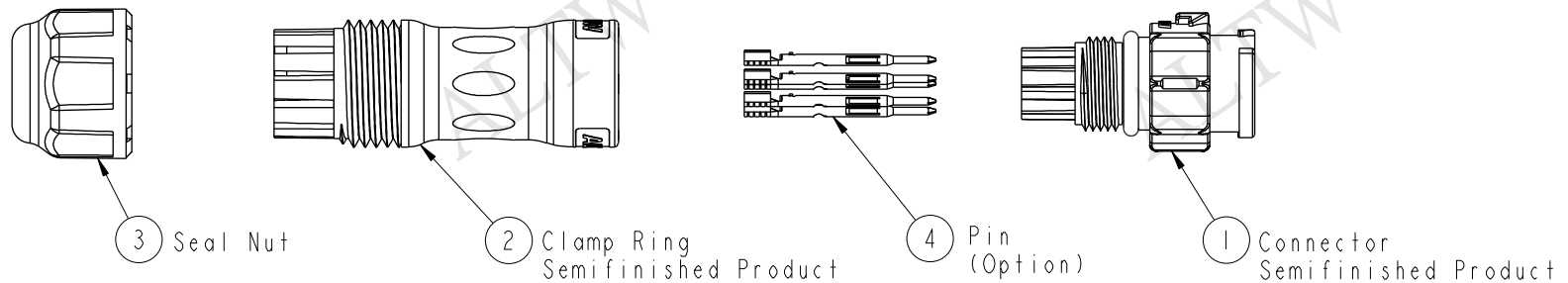

Material Specification:

- * Connector: Thermoplastic, Black.
- * Terminal: Copper Alloy, Gold Plated.
- * Gasket & O-Ring: Rubber.
- * UL Rated: UL 94V-0, fl.
- * RoHS Compliant.

Electrical Specification:

- * Contact Resistance: 10mΩ Max.
- * Insulation Resistance: 100MΩ Min.
- * Dielectric Withstand Voltage: 1,600 Vac.

Mechanical Specification:

- * Durability: 1000 Cycles.
- * Tensile strength: 10 kgf.
- * Wire Conductor:
 - 5A: 22AWG~20AWG
 - 10A: 18AWG~16AWG
- * Wire Insulation OD:
 - 5A: 1.9mm Max.
 - 10A: 2.7mm Max.
- * Torque Force for Clamp Ring: 6~8 kgf-cm
- * Torque Force for Seal Nut: 6~8 kgf-cm

Environmental Specification:

- * Waterproof Rating: IP68(Mated, 1M/24 Hours)
- * Temperature Range: -40°C to 105°C.
- * Salt Spray: Mated, 1000 Hours.
- * Safety Compliance: UL 1977.

UNIT:mm		
TOLERANCE		
±0.5 mm		

TITLE X-Lok B-Size Field Installable Cable Type M Conn			
SCALE 8:5	SIZE A4	SHEET 1 OF 2	
REV. A	WC-REV. A.3	QC: Inspection item	

Amphenol LTW
安費諾亮泰企業股份有限公司

ITEM NO	DRAWN BY Victor Hung	DATE 2016/11/03
DWG NO BX-0XBMA-QL8XX0	CHECKED BY Wes Fan	DATE 2016/11/03
CUSTOMER ALTW	APPROVED BY Kevin Hu	DATE 2016/11/03

THIS DOCUMENT IS SUBJECT TO CHANGE WITHOUT NOTICE. IT IS CONFIDENTIAL AND A PROPERTY OF Amphenol LTW. DISCLOSURE TO THIRD PARTY HAS TO BE AUTHORIZED BY Amphenol LTW.

Ordering Information:

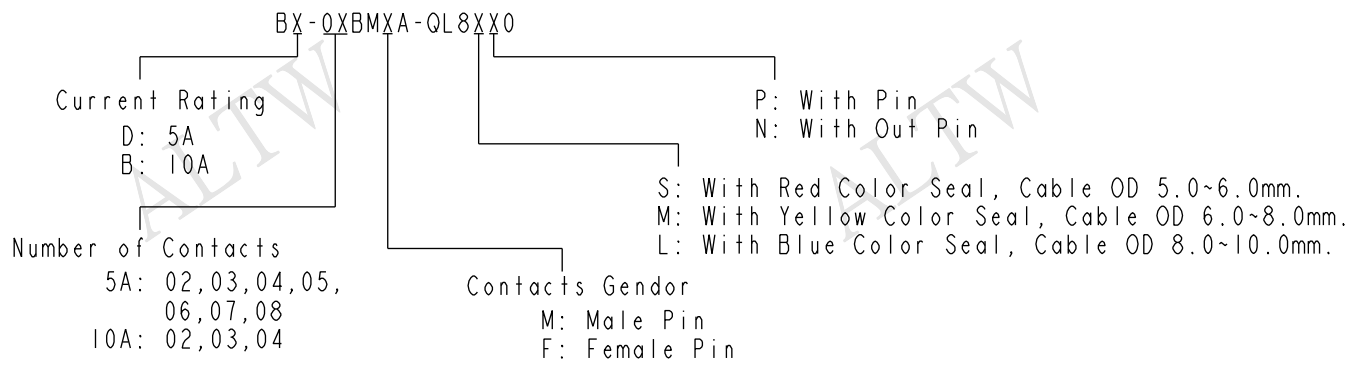

Mating Connector:
 Overmolded with Cable: BX-0XAFXM-QL8XXX
 Receptacle: BX-0XXFXS-QX8001
 Field Installable: BX-0XBFXA-QL8XX0

Tool Part No:
 ASST-C-XXA-W-A

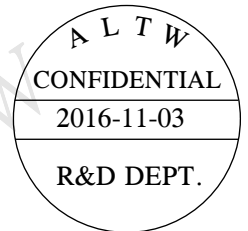
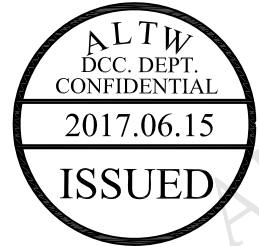

Pin Assignments Front View	10A ; 300Vac/Vdc 2 Contacts(02)	10A ; 300Vac/Vdc 3 Contacts(03)	10A ; 300Vac/Vdc 4 Contacts(04)	5A ; 300Vac/Vdc 2 Contacts(02)	5A ; 300Vac/Vdc 3 Contacts(03)	5A ; 300Vac/Vdc 4 Contacts(04)	5A ; 300Vac/Vdc 5 Contacts(05)	5A ; 300Vac/Vdc 6 Contacts(06)	5A ; 300Vac/Vdc 7 Contacts(07)	5A ; 300Vac/Vdc 8 Contacts(08)
Male Pin										
Female Pin										

UNIT:mm TOLERANCE ±0.5 mm	TITLE X-Lok B-Size Field Installable Cable Type M Conn		<h2 style="text-align: center;">Amphenol LTW</h2> <p style="text-align: center;">安費諾亮泰企業股份有限公司</p>		ITEM NO	DRAWN BY Victor Hung	DATE 2016/11/03
	SCALE 8:5	SIZE A4			SHEET 2 OF 2	DWG NO BX-0XBMXA-QL8XX0	CHECKED BY Wes Fan
	REV. A	WC-REV. A.3	QC: Inspection item	CUSTOMER ALTW	APPROVED BY Kevin Hu	DATE 2016/11/03	