

General Purpose Relay LY

- Arc barrier equipped.
- High dielectric strength (2,000 VAC).
- Long dependable service life assured by Ag-Alloy contacts.
- Choose models with single or bifurcated contacts, LED indicator, diode surge suppression, push-to-test button, or RC circuit.
- UL, CSA, TUV, and CE approvals on all standard LY Relay Part Numbers.

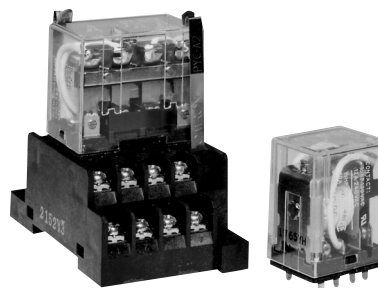

Ordering Information

To Order: Select the part number and add the desired coil voltage rating (e.g., LY1-DC6).

Type	Terminal	Contact form	Model			
			Single contact		Bifurcated contact	
			Standard bracket mounting	Upper mounting bracket	Standard bracket mounting	Upper mounting bracket
Standard	Plug-in/solder	SPDT	LY1	LY1F	—	—
		DPDT	LY2	LY2F	LY2Z	LY2ZF
		3PDT	LY3	LY3F	—	—
		4PDT	LY4	LY4F	—	—
	PCB	SPDT	LY1-0	—	—	—
		DPDT	LY2-0	—	LY2Z-0	—
		3PDT	LY3-0	—	—	—
		4PDT	LY4-0	—	—	—
LED indicator	Plug-in/solder	SPDT	LY1N	—	—	—
		DPDT	LY2N	—	LY2ZN	—
		3PDT	LY3N	—	—	—
		4PDT	LY4N	—	—	—
Diode surge suppression	Plug-in/solder	SPDT	LY1-D	—	—	—
		DPDT	LY2-D	—	LY2Z-D	—
		3PDT	LY3-D	—	—	—
		4PDT	LY4-D	—	—	—
LED indicator and diode surge suppression	Plug-in/solder	SPDT	LY1N-D2	—	—	—
		DPDT	LY2N-D2	—	LY2ZN-D2	—
		4PDT	LY4N-D2	—	—	—
RC circuit	Plug-in/solder	SPDT	LY1-CR	—	—	—
		DPDT	LY2-CR	—	LY2Z-CR	—
LED indicator and RC circuit	Plug-in/solder	SPDT	LY1N-CR	—	—	—
		DPDT	LY2N-CR	—	LY2ZN-CR	—

- Note:**
1. Types with specifications other than those listed are available. Contact your Omron Sales representative.
 2. To order connecting sockets and mounting tracks, see "Accessories" section.
 3. Relays with RC circuit are only available in AC coil voltages of 100 VAC or greater.

Type	Terminal	Contact form	Model			
			Single contact		Bifurcated contact	
			Standard bracket mounting	Upper mounting bracket	Standard bracket mounting	Upper mounting bracket
Push-to-test button	Plug-in/solder	SPDT	LY114	—	—	—
		DPDT	LY214	—	LY2ZI2	—
		3PDT	LY314	—	—	—
		4PDT	LY414	—	—	—
LED indicator and push-to-test button	Plug-in/solder	DPDT	LY214N	—	LY2ZI2N	—
		4PDT	LY414N	—	—	—

Note: 1. Types with specifications other than those listed are available. Contact your Omron Sales representative.
 2. To order connecting sockets and mounting tracks, see “Accessories” section.

■ Accessories

Connecting Sockets

To Order: Select the appropriate part numbers for sockets, clips, and mounting tracks (if required) from the following charts.

Track Mounted Sockets

Relay	Socket*	Relay hold-down clip		Mounting track
		Standard	RC circuit	
SPDT DPDT	PTF08A-E	PYC-A1	Y92H-3	PFP-100N/PFP-50N & PFP-M or PFP-100N2 PFP-S (Option spacer)
3PDT	PTF11A			
4PDT	PTF14A-E			

* Track mounted socket can be used as a front connecting socket.

Back Connecting Sockets

Relay	Solder terminal socket	Wire wrap terminal socket	Relay hold-down clip				Socket Mounting Plate			
			Standard	Push-to-test	RC circuit	Mtg. plate	1	10	12	18
SPDT DPDT	PT08	PT08QN	PYC-P	PYC-P2	PYC-1	PYC-S	PYP-1	—	—	PYP-18
3PDT	PT11	PT11QN					PTP-1-3	—	PTP-12	—
4PDT	PT14	PT14QN					PTP-1	PTP-10	—	—

Note: Types PYP-18, PTP-12 and PTP-10 may be cut to any desired length.

Relay	PC terminal socket	Relay hold-down clip		
		Standard	Push-to-test	RC circuit
SPDT DPDT	PT08-0	PYC-P	PYC-P2	PYC-1
3PDT	PT11-0			
4PDT	PT14-0			

Specifications

■ Contact Data

Load	Single contact				Bifurcated contact	
	SPDT		DPDT, 3PDT, 4PDT		DPDT	
	Resistive load (p.f. = 1)	Inductive load (p.f. = 0.4) (L/R = 7 ms)	Resistive load (p.f. = 1)	Inductive load (p.f. = 0.4) (L/R = 7 ms)	Resistive load (p.f. = 1)	Inductive load (p.f. = 0.4) (L/R = 7 ms)
Rated load	15 A at 110 VAC 15 A at 24 VDC	10 A at 110 VAC 7 A at 24 VDC	10 A at 110 VAC 10 A at 24 VDC	7.5 A at 110 VAC 5 A at 24 VDC	5 A at 110 VAC 5 A at 24 VDC	4 A at 110 VAC 4 A at 24 VDC
Contact material	Ag-Alloy					
Carry current	15 A		10 A		7 A	
Max. operating voltage	250 VAC 125 VDC					
Max. operating current	15 A		10 A		7 A	
Max. switching capacity	1,700 VA 360 W	1,100 VA 170 W	1,100 VA 240 W	825 VA 120 W	550 VA 120 W	440 VA 100 W
Min. permissible load	100 mA, 5 VDC				10 mA, 5 VDC	

■ Coil Data

1- and 2-pole Types – AC

Rated voltage (V)	Rated current (mA)		Coil resistance (Ω)	Coil inductance (ref. value) (H)		Pick-up voltage	Dropout voltage	Maximum voltage	Power consumption (VA, W)
	50 Hz	60 Hz		Armature OFF	Armature ON				
6	214.10	183	12.20	0.04	0.08	80% max.	30% min.	110%	Approx. 1.00 to 1.20 (60 Hz)
12	106.50	91	46	0.17	0.33				
24	53.80	46	180	0.69	1.30				
50	25.70	22	788	3.22	5.66				
100/110	11.70/12.90	10/11	3,750	14.54	24.60				
110/120	9.90/10.80	8.40/9.20	4,430	19.20	32.10				
200/220	6.20/6.80	5.30/5.80	12,950	54.75	94.07				
220/240	4.80/5.30	4.20/4.60	18,790	83.50	136.40			Approx. 0.90 to 1.10 (60 Hz)	

1- and 2-pole Types – DC

Rated voltage (V)	Rated current (mA)	Coil resistance (Ω)	Coil inductance (ref. value) (H)		Pick-up voltage	Dropout voltage	Maximum voltage	Power consumption (VA, W)
			Armature OFF	Armature ON				
6	150	40	0.16	0.33	80% max.	10% min.	110%	Approx. 0.90
12	75	160	0.73	1.37				
24	36.90	650	3.20	5.72				
48	18.50	2,600	10.60	21				
100/110	9.10/10	11,000	45.60	86.20				

- Note:**
1. The rated current and coil resistance are measured at a coil temperature of 23°C (73°F) with tolerances of +15%, -20% for AC rated current, and ±15% for DC rated coil resistance.
 2. The AC coil resistance and inductance are reference values at 60 Hz.
 3. The performance characteristics are measured at a coil temperature of 23°C (73°F).
 4. Class B coil insulation is available.

3-pole Type – AC

Rated voltage (V)	Rated current (mA)		Coil resistance (Ω)	Coil inductance (ref. value) (H)		Pick-up voltage	Dropout voltage	Maximum voltage	Power consumption (VA, W)
	50 Hz	60 Hz		Armature OFF	Armature ON				
6	310	270	6.70	0.03	0.05	80% max.	30% min.	110%	Approx. 1.60 to 2.00 (60 Hz)
12	159	134	24	0.12	0.21				
24	80	67	100	0.44	0.79				
50	38	33	410	2.24	3.87				
100/110	15.90/18.30	13.60/15.60	2,300	10.50	18.50				
120	17.30	14.8	2,450	11.50	20.60				
200/220	10.50/11.60	9.00/9.90	8,650	34.80	59.50				
240	9.40	8	10,400	38.60	74.60				

3-pole Type – DC

Rated voltage (V)	Rated current (mA)		Coil resistance (Ω)	Coil inductance (ref. value) (H)		Pick-up voltage	Dropout voltage	Maximum voltage	Power consumption (VA, W)
				Armature OFF	Armature ON				
6	234		25.70	0.11	0.21	80% max.	10% min.	110%	Approx. 1.40
12	112		107	0.45	0.98				
24	58.60		410	1.89	3.87				
48	28.20		1,700	8.53	13.90				
100/110	12.70/13		8,500	29.60	54.30				

4-pole Type – AC

Rated voltage (V)	Rated current (mA)		Coil resistance (Ω)	Coil inductance (ref. value) (H)		Pick-up voltage	Dropout voltage	Maximum voltage	Power consumption (VA, W)
	50 Hz	60 Hz		Armature OFF	Armature ON				
6	386	330	5	0.02	0.04	80% max.	30% min.	110%	Approx. 1.95 to 2.50 (60 Hz)
12	199	170	20	0.10	0.17				
24	93.60	80	78	0.38	0.67				
50	46.80	40	350	1.74	2.88				
100/110	22.50/25.50	19/21.80	1,800	10.50	17.30				
120	19.00	16.40	2,200	9.30	19				
200/220	11.50/13.10	9.80/11.20	6,700	33.10	57.90				
240	11.00	9.50	9,000	33.20	63.40				

4-pole Type – DC

Rated voltage (V)	Rated current (mA)		Coil resistance (Ω)	Coil inductance (ref. value) (H)		Pick-up voltage	Dropout voltage	Maximum voltage	Power consumption (VA, W)
				Armature OFF	Armature ON				
6	240		25	0.09	0.21	80% max.	10% min.	110%	Approx. 1.50
12	120		100	0.39	0.84				
24	69		350	1.41	2.91				
48	30		1,600	6.39	13.60				
100/110	15/15.90		6,900	32	63.70				

- Note:**
1. The rated current and coil resistance are measured at a coil temperature of 23°C (73°F) with tolerances of +15%, -20% for AC rated current, and ±15% for DC rated coil resistance.
 2. The AC coil resistance and inductance are reference values at 60 Hz.
 3. The performance characteristics are measured at a coil temperature of 23°C (73°F).
 4. Class B coil insulation is available.

Characteristics

Contact resistance		50 mΩ max.
Operate time		25 ms max.
Release time		25 ms max.
Operating frequency	Mechanically	18,000 operations/hour
	Under rated load	1,800 operations/hour
Insulation resistance		100 MΩ min. (at 500 VDC)
Dielectric strength		2,000 VAC, 50/60 Hz for 1 minute 1,000 VAC, 50/60 Hz for 1 minute between contacts of same polarity
Vibration	Mechanical durability	10 to 55 Hz, 1.00 mm (0.04 in) double amplitude
	Malfunction durability	10 to 55 Hz, 1.00 mm (0.04 in) double amplitude
Shock	Mechanical durability	1,000 m/s ² (approx. 100 G)
	Malfunction durability	200 m/s ² (approx. 20 G)
Ambient temperature	Operating	LY1, LY2, LY3: -25° to 55°C; LY4 = -25° to 40°C
Humidity		35 to 85% RH
Service Life	Mechanically	AC: 50 million operations min. (at operating frequency of 18,000 operations/hour) DC: 100 million operations min. (at operating frequency of 18,000 operations/hour)
	Electrically	See "Characteristic Data"
Weight		SPDT, DPDT: Approx. 40 g (1.41 oz), 3PDT: Approx. 50 g (1.76 oz) 4PDT: Approx. 70 g (2.47 oz)

Note: Data shown are of initial value.

Characteristic Data

Maximum switching capacity

LY1

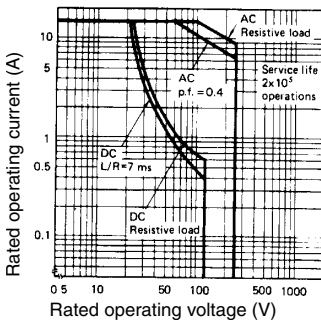

LY2

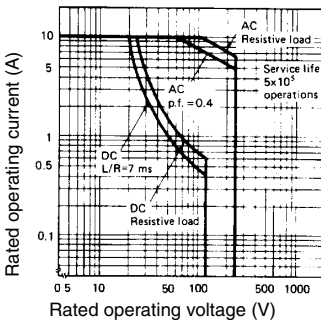

LY3, LY4

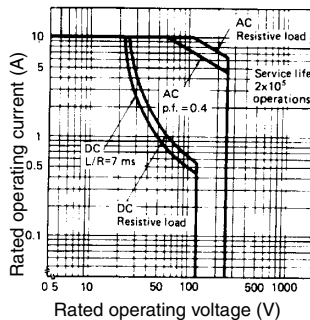

LY2Z

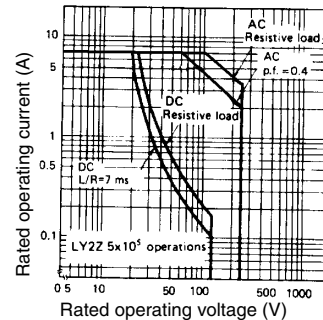

Electrical service life

LY1

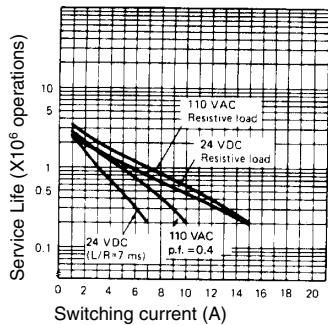

LY2

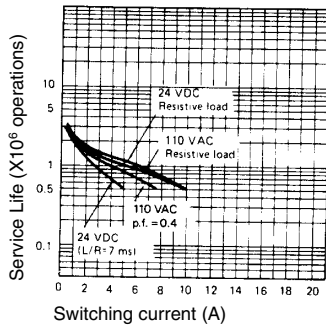

LY3, LY4

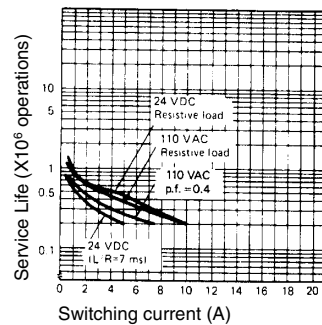

LY2Z

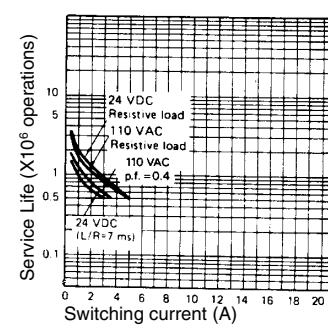

Dimensions

Unit: mm (inch)

Relays

LY1

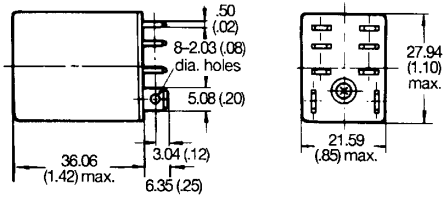

Terminal arrangement (Bottom view)

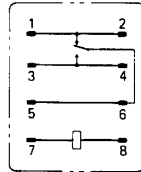

LY2

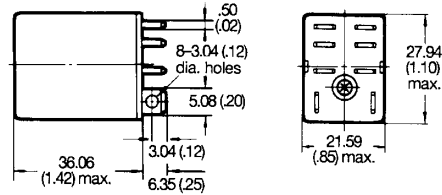

Terminal arrangement (Bottom view)

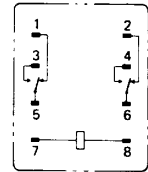

LY3

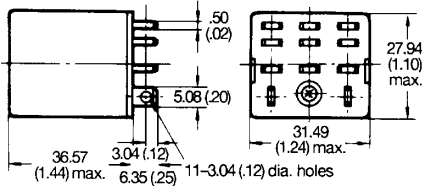

Terminal arrangement (Bottom view)

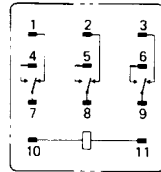

LY4

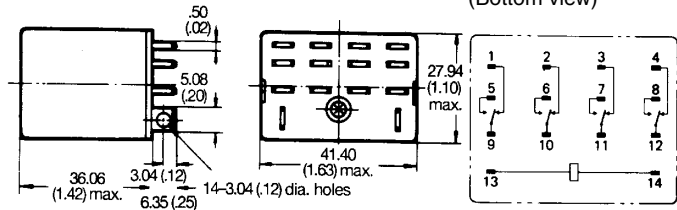

Terminal arrangement (Bottom view)

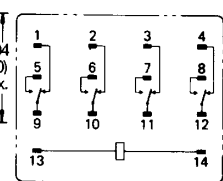

LY1-0, LY2-0, LY3-0, LY4-0

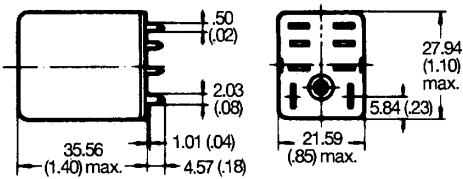

Mounting holes for LY1-0, LY2-0, LY3-0, LY4-0 (Bottom view)

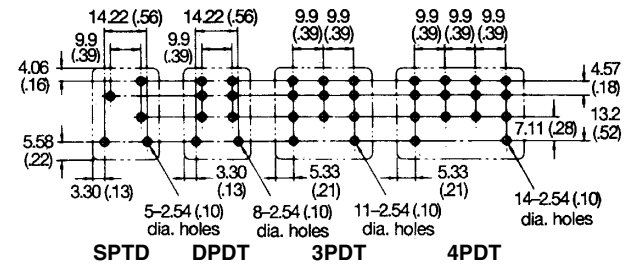

Note: The above drawing shows LY2-0. With LY1-0, dimension "*" should read as eight 6.35 (.25).

LY1F, LY2F

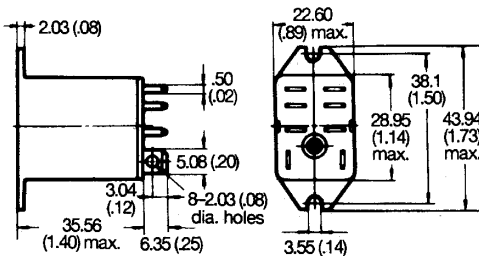

Mounting holes

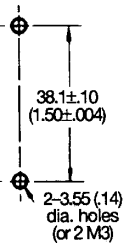

LY3F

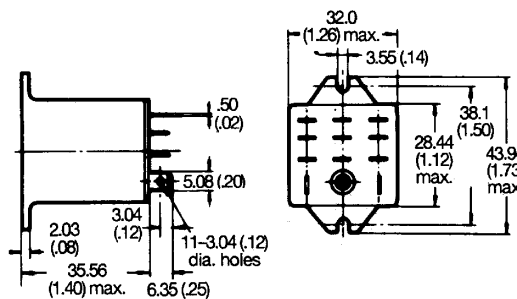

Mounting holes

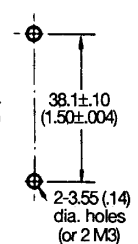

Note: The above drawing shows LY1F. With LY2F, dimension "*" should read as eight 3.05 mm (0.12 in) dia. holes.

LY4F

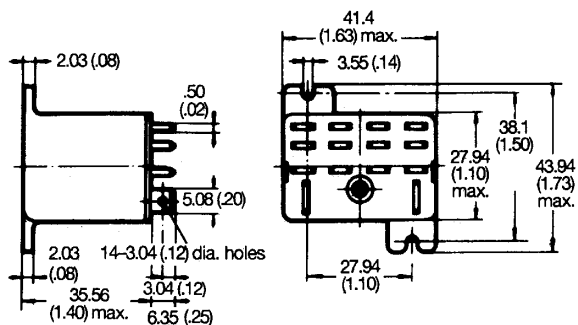

Mounting holes

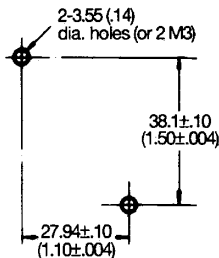

LY1S, LY2S

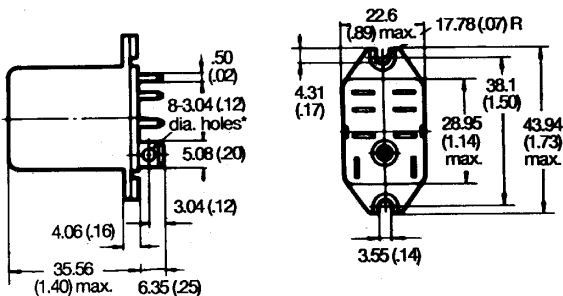

Round hole

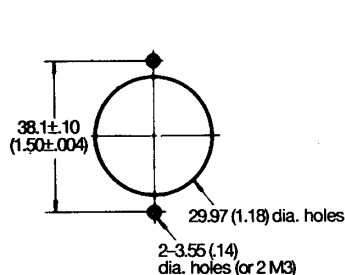

Rectangular hole

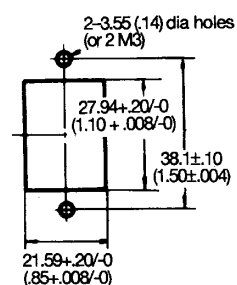

Note: The above drawing shows LY2S-US. With LY1S-US, dimension *** should read as eight 2.03 mm (0.08 in) dia. holes.

LY3S

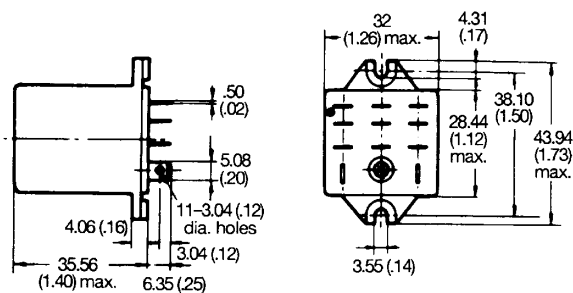

Round hole

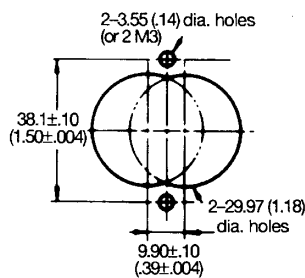

Rectangular hole

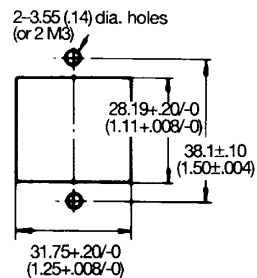

LY4S

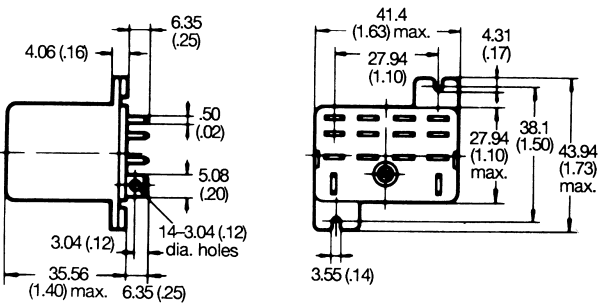

Round hole

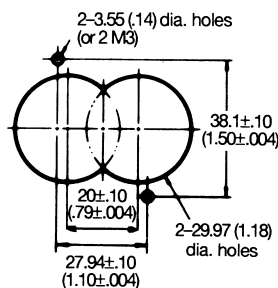

Rectangular hole

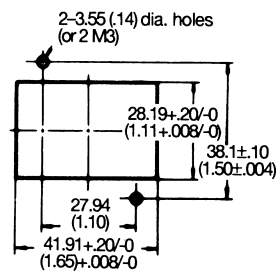

■ Accessories

Unit: mm (inch)

Track mounted sockets (UL File No. E87929) (CSA Report No. LR31928)

PTF08A
(see note 3)

**Terminal arrangement/
mounting holes**
(Top view)

PTF11A

**Terminal arrangement/
mounting holes**
(Top view)

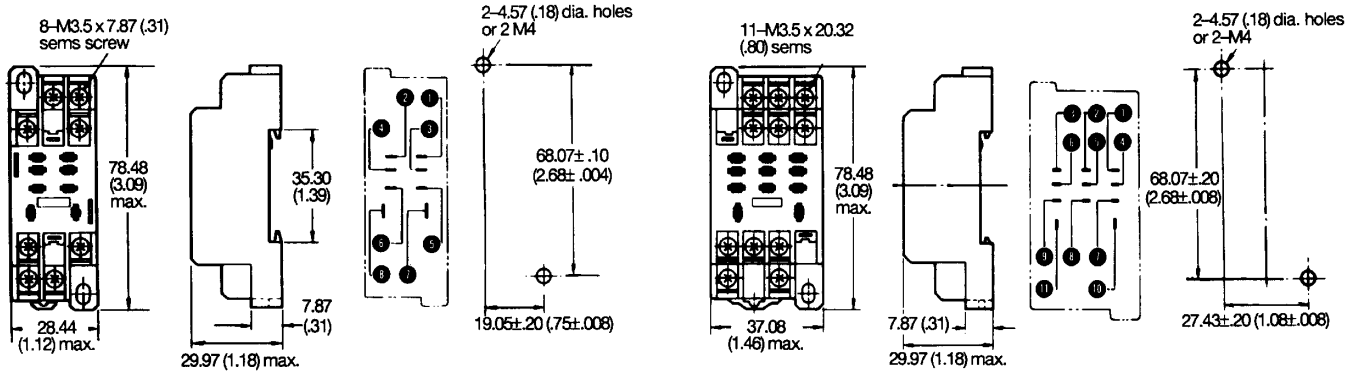

Track mounting sockets (UL File No. E87929) (CSA Report No. LR31928)

PTF14A
(see note 3)

**Terminal arrangement/
mounting holes**
(Top view)

**Mounting height of
relay with socket**
(Applies to all PTF□A sockets)

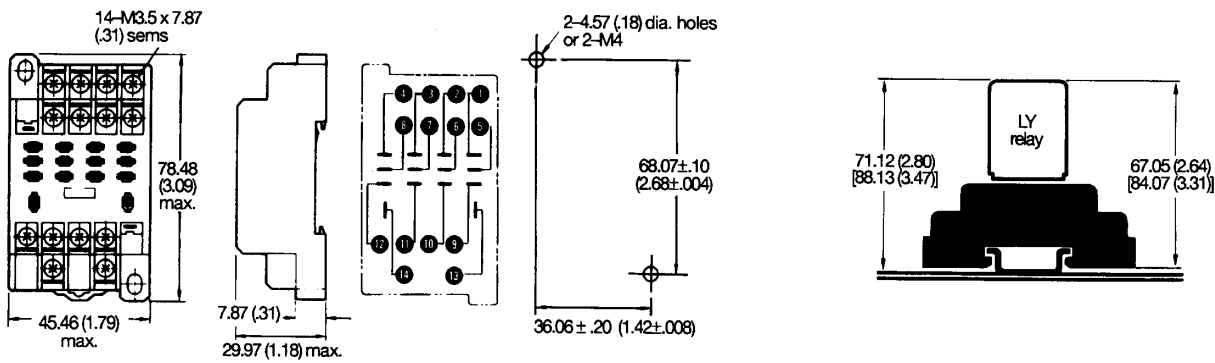

- Note:**
1. UL/CSA does not apply to wire wrap (Q) type sockets.
 2. Values in brackets for LY□CR.
 3. PTF08A-E and PTF14A-E = touch safe screws. Height = 33 mm max.

Back connecting socket (UL File No. E87929) (CSA Report No. LR31928)

PT08

**Terminal arrangement/
(Bottom view)**

PT11

**Terminal arrangement/
(Bottom view)**

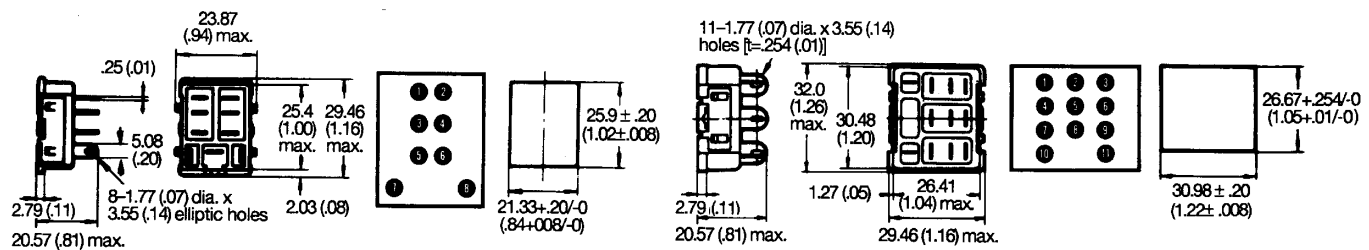

Back connecting socket (UL File No. E87929) (CSA Report No. LR31928)

PT14

Terminal arrangement
(Bottom view)

Mounting height of relay with socket
(Applies to all PT sockets)

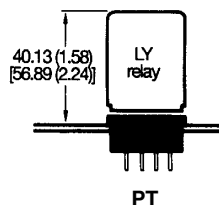
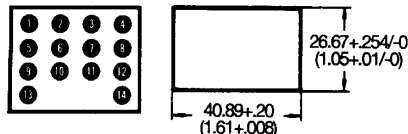
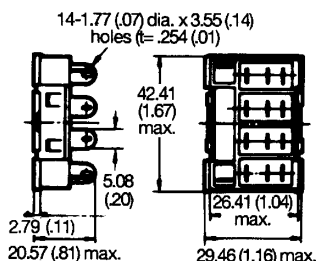

Note: Values in brackets for LY□CR.

Back connecting socket (UL File No. E87929) (CSA Report No. LR31928)

PT08QN

Panel cut-out and terminal arrangement are the same as Type PT08.

PT11QN

Panel cut-out and terminal arrangement are the same as Type PT11.

PT14QN

Panel cut-out and terminal arrangement are the same as Type PT14.

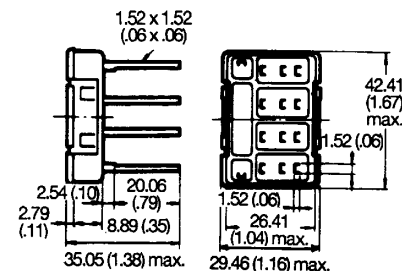
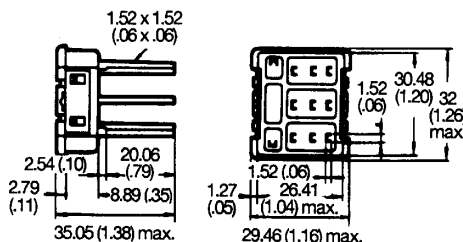
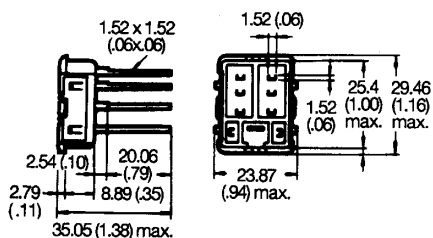

Back connecting socket (UL File No. E87929) (CSA Report No. LR31928)

PT08-0

Terminal arrangement is the same as Type PT08.

Mounting holes
(Bottom view)

PT11-0

Terminal arrangement is the same as Type PT11.

Mounting holes
(Bottom view)

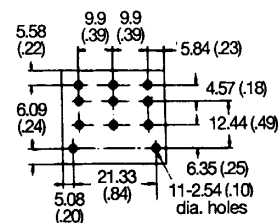
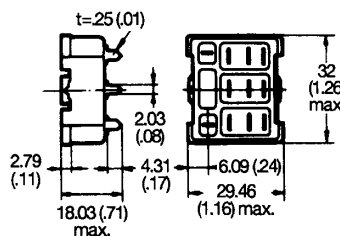
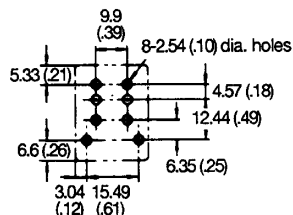
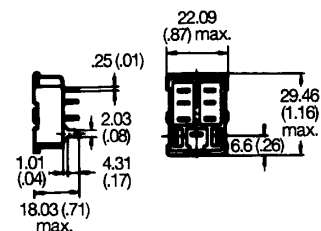

Back connecting socket (UL File No. E87929) (CSA Report No. LR31928)

PT14-0

Terminal arrangement is the same as Type PT14.

Mounting holes
(Bottom view)

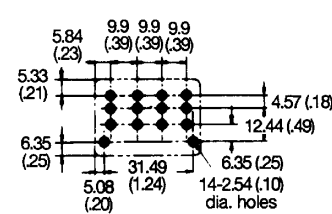
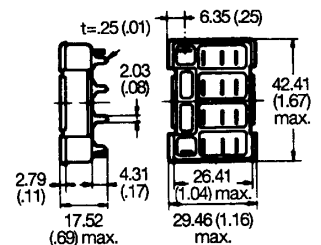

Unit: mm (inch)

Relay hold-down clips

PYC-A1

For PTF□A socket

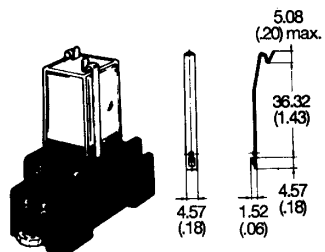

PYC-S

For relay mounting plates
(Applicable to Type PYP-1 and PYP-18 socket mounting plates only.)

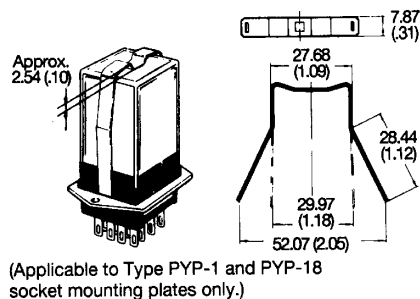

PYC-P

For PT□ socket

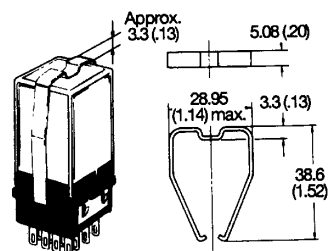

Relay hold-down clips

PYC-P2

For push-to-test button type with PT□ socket

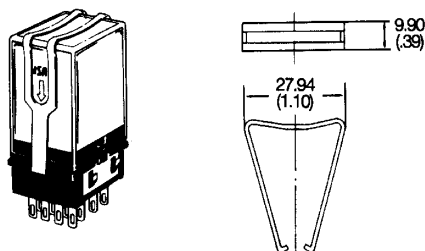

Y92H-3

For RC circuit type

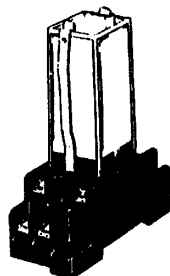

PYC-1

For RC circuit type



Mounting track/end plate/spacer

PFP-100N, PFP-50N
(Conforming to EN 50022)

PFP-100N2
(Conforming to EN 50022)

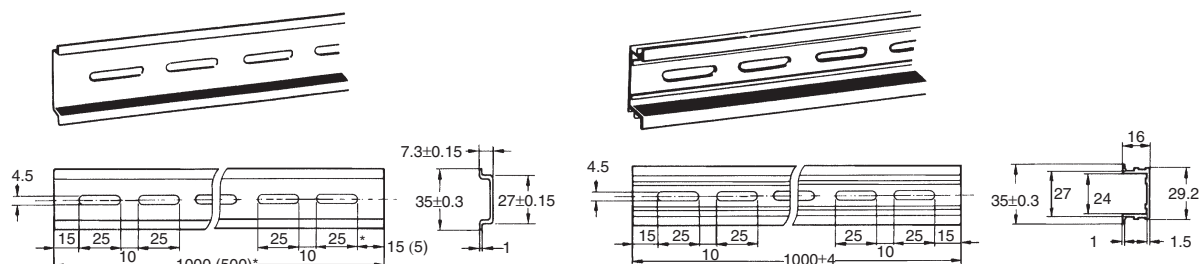

* The figure in parenthesis is for PFP-50N.

*This dimension is 14.99 mm (0.59 in) on both ends in the case of PFP-100N, but on one end in the case of PFP-50N.

** L = Length

PFP-50N L = 497.84 mm (19.60 in)

PFP-100N L = 990.60 mm (39.00 in)

PFP-100N2 L = 990.60 mm (39.00 in)

***A total of twelve 24.89 x 4.57 mm (0.98 x 0.18 in) elliptic holes are provided, with six holes cut from each end of the track at a pitch of 9.91 (0.39) between holes.

FFP-M end plate

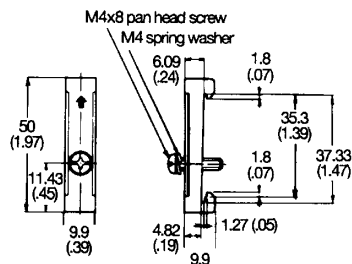

FFP-S spacer

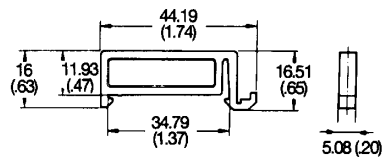

Socket mounting plates [t=1.52 (.06)]

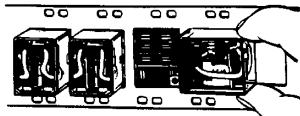

Socket needed	Number of socket specs.			
	1	10	12	18
PT08, PT08QN	PYP-1	-	-	PYP-18
PT11, PT11QN	PTP-1-3	-	PTP-1-2	-
PT14, PT14QN	PTP-1	PTP-10	-	-
PTP-10	PTP-12			

PYP-1

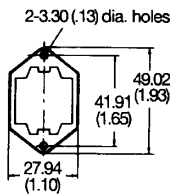

PTP-1-3

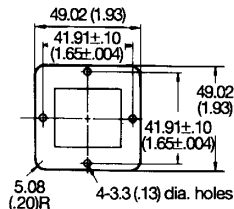

PTP-1

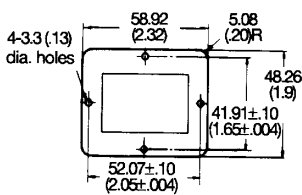

PYP-18

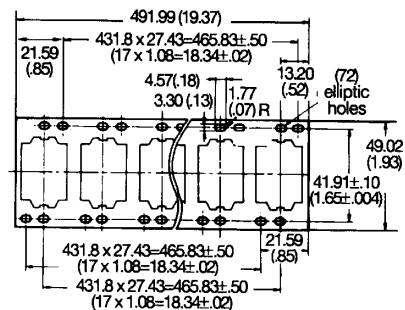

PTP-10

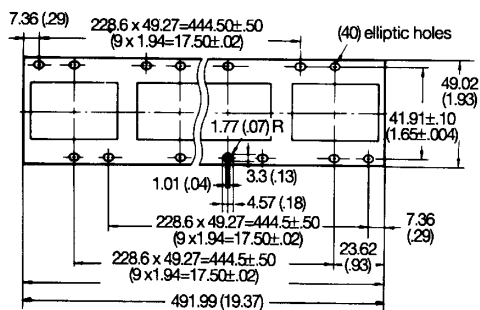

PTP-12

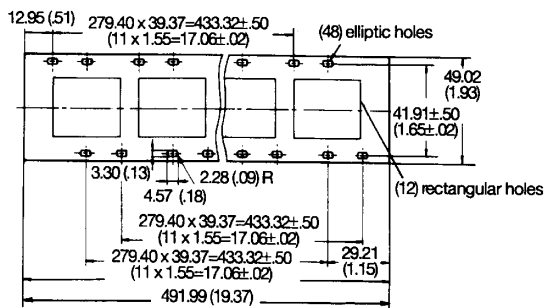

■ Relay Options

LED Indicator

Specifications and dimensions same as the Standard Type with the following exception. With the LED indicator type, the rated current is approximately 0 to 5.0 mA higher than the Standard Type.

Terminal arrangement/Internal connections (Bottom view)

LY2N

DC coil rating type

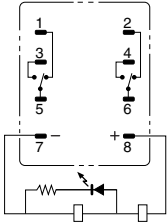

AC coil rating type

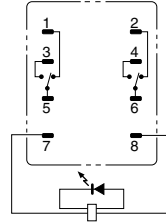

- Note:**
1. The coil terminals 10 and 11 of Type LY3N become (-) and (+) and terminals 13 and 14 of Type LY4N become (-) and (+), respectively.
 2. Pay special attention to the polarities when using the DC type.

Diode Surge Suppression

Specifications and dimensions same as the Standard Type with the following exception. Ambient operating temperature: -25° to 40°C (-13° to 104°F)

Without Diode

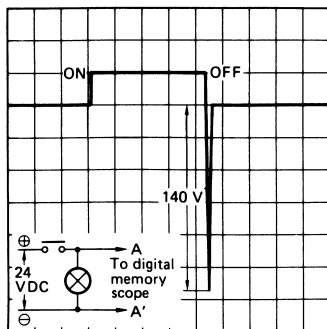

With Diode

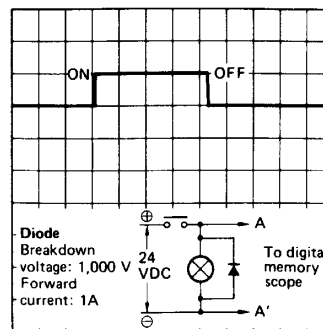

Terminal arrangement/Internal connections (Bottom view)

LY2(N)-D(2)

LY2-D
6, 12, 24, 48
100/110 VDC

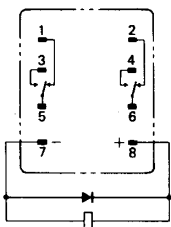

LY2N-D2
6, 12, 24, 48 VDC

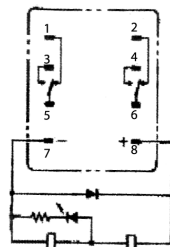

LY2N-D2
100/110 VDC

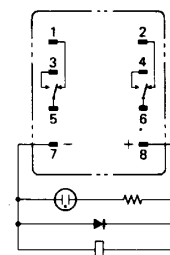

- Note:**
1. Pay special attention to the polarities when using the DC type.
 2. The release time is somewhat longer, but satisfies the standard specifications of 25 ms.
 3. The reverse-breakdown voltage of the diode is 1,000 VDC.
 4. Available on DC versions only.

Relay Options

RC Circuit

Specifications and dimensions same as the Standard Type with the following exceptions.

Characteristic Data

Without RC circuit

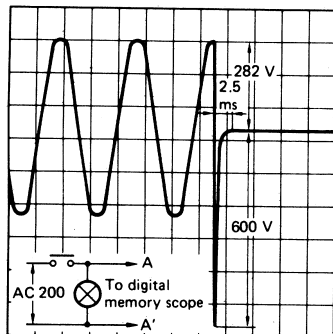

With RC circuit

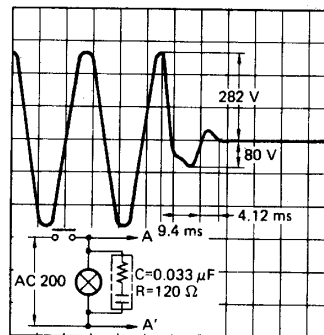

LY1-CR, LY2(Z)-CR

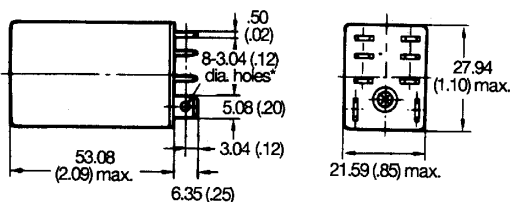

Terminal arrangement/Internal connections (Bottom view)

LY1-CR

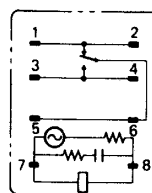

LY2(Z)-CR

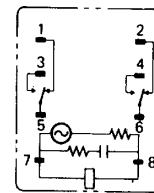

RC circuit
C: 0.033 μF
R: 120 Ω

- Note:**
- The above drawing shows LY2(Z)-CR. With LY1-CR, "*" should read eight 2.03 mm (0.08 in) dia. holes.
 - Available on AC versions only.

Push-to-test Button

Specifications and dimensions same as the Standard Type with the following exceptions.

LY□12

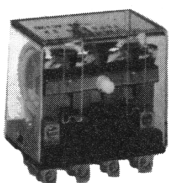

LY112, LY212

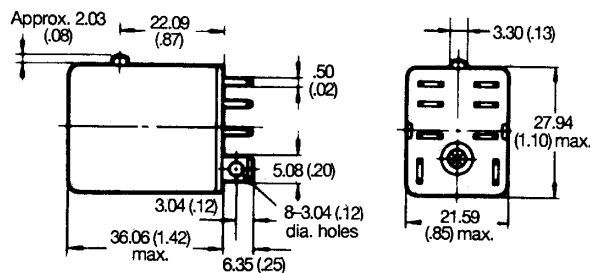

- Note:** Type LY112 has the same dimensions and appearances as Type LY212 shown except that dimensions "*" is 2.03 mm (0.08 in) dia. holes.

LY312

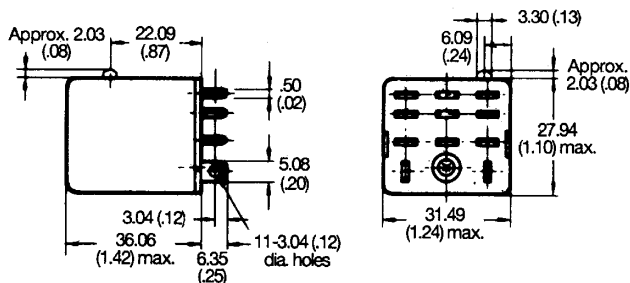

LY412

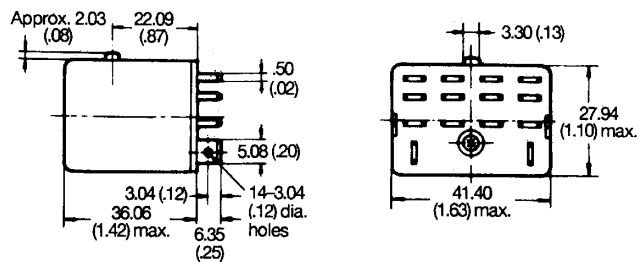

■ Approvals

UL Recognized Type (File No. E41643)

Type	Contact form	Coil ratings	Contact ratings	Number of test operations
LY1□	SPDT	6 to 240 VAC 6 to 120 VDC	15A, 30VDC (Resistive), 40°C	6 x 10 ³
			15A, 240VAC (General use), 40°C	
			TV-5, 120VAC, 40°C	25 x 10 ³
			1/2HP, 120VAC, 50°C	
LY2□	DPDT		15A, 28VDC (Resistive), 40°C	6 x 10 ³
			15A, 120VAC (Resistive), 40°C	
			12A, 240VAC (General use), 40°C	25 x 10 ³
			1/2HP, 120VAC, 50°C	
	TV-3, 120VAC, 40°C			
LY3□	3PDT		10A, 30VDC (Resistive), 40°C (Same polarity)	6 x 10 ³
LY4□	4PDT		10A, 240VAC (General use), 40°C (Same polarity)	
			1/2HP, 240VAC, 40°C	
LY2Z□ (Bifurcated)	DPDT		7A, 240VAC (General use), 40°C	6 x 10 ³
			7A, 28VDC (Resistive), 40°C	

CSA Certified Type (File No. LR31928)

Type	Contact form	Coil ratings	Contact ratings
LY1□	SPDT	6 to 240 VAC 6 to 120 VDC	15 A, 120 VAC (Inductive)
			10 A, 240 VAC (Inductive)
			15 A, 28 VDC (Resistive)
			TV-5 (ACTV)
LY2□	DPDT		13 A, 28 VDC (Resistive)
			12 A, 120 VAC (Inductive)
			10 A, 240 VAC (Inductive)
			1/3 HP, 120 VAC (Motor)
			TV-3 (ACTV)
LY3□	3PDT		10 A, 240 VAC (Inductive)
LY3□	4PDT		10 A, 28 VDC (Resistive)

VDE Approved Type (File No. 9903 [SPDT, DPDT & 3PDT], File No. 9947 [4PDT])

Type	Contact form	Coil ratings	Contact ratings
LY□-VD	SPDT	6, 12, 24, 50, 110, 220 VAC and 6, 12, 24, 48, 110 VDC	10 A, 220 VAC (Resistive)
			10 A, 28 VDC (Resistive)
			7 A, 220 VAC (Inductive)
			7 A, 28 VDC (Inductive)
LY□-VD	DPDT		7 A, 220 VAC (Resistive)
	3PDT		7 A, 28 VDC (Resistive)
	4PDT		4 A, 28 VDC and 4A, 220 VAC (Inductive)

LR (Lloyd's Register) Approved Type (File No. 562KOB-204523)

Type	Contact form	Coil ratings	Contact ratings
LY□	DPDT	6 to 240 VAC	7.5 A, 230 VAC (Inductive)
	4PDT	6 to 110 VDC	5 A, 24 VDC (Inductive)

SEV Listed Type (File No. D7 91/82 [2- & 4-pole], D 91/204a [1- & 3-pole])

Type	Contact form	Coil ratings	Contact ratings
LY□-SV	SPDT	6 to 240 VAC 6 to 110 VDC	15 A, 220 VAC (Resistive)
			15 A, 24 VDC (Resistive)
LY□-SV	DPDT		10 A, 220 VAC (Resistive)
	3PDT		10 A, 24 VDC (Resistive)
	4PDT		

- Note:**
1. The rated values approved by each of the safety standards (e.g., UL, CSA, VDE, and SEV) may be different from the performance characteristics individually defined in this catalog.
 2. In the interest of product improvement, specifications are subject to change.

Omron Electronic Components, LLC

Terms and Conditions of Sales

I. GENERAL

- Definitions:** The words used herein are defined as follows.
 - Terms:** These terms and conditions
 - Seller:** Omron Electronic Components LLC and its subsidiaries
 - Buyer:** The buyer of Products, including any end user in section III through VI
 - Products:** Products and/or services of Seller
 - Including:** Including without limitation
- Offer; Acceptance:** These Terms are deemed part of all quotations, acknowledgments, invoices, purchase orders and other documents, whether electronic or in writing, relating to the sale of Products by Seller. Seller hereby objects to any Terms proposed in Buyer's purchase order or other documents which are inconsistent with, or in addition to, these Terms.
- Distributor:** Any distributor shall inform its customer of the contents after and including section III of these Terms.

II. SALES

- Prices; Payment:** All prices stated are current, subject to change without notice by Seller. Buyer agrees to pay the price in effect at the time the purchase order is accepted by Seller. Payments for Products received are due net 30 days unless otherwise stated in the invoice. Buyer shall have no right to set off any amounts against the amount owing in respect of this invoice.
- Discounts:** Cash discounts, if any, will apply only on the net amount of invoices sent to Buyer after deducting transportation charges, taxes and duties, and will be allowed only if (a) the invoice is paid according to Seller's payment terms and (b) Buyer has no past due amounts owing to Seller.
- Interest:** Seller, at its option, may charge Buyer 1.5% interest per month or the maximum legal rate, whichever is less, on any balance not paid within the stated terms.
- Orders:** Seller will accept no order less than 200 U.S. dollars net billing.
- Currencies:** If the prices quoted herein are in a currency other than U.S. dollars, Buyer shall make remittance to Seller at the then current exchange rate most favorable to Seller; provided that if remittance is not made when due, Buyer will convert the amount to U.S. dollars at the then current exchange rate most favorable to Seller available during the period between the due date and the date remittance is actually made.
- Governmental Approvals:** Buyer shall be responsible for all costs involved in obtaining any government approvals regarding the importation or sale of the Products.
- Taxes:** All taxes, duties and other governmental charges (other than general real property and income taxes), including any interest or penalties thereon, imposed directly or indirectly on Seller or required to be collected directly or indirectly by Seller for the manufacture, production, sale, delivery, importation, consumption or use of the Products sold hereunder (including customs duties and sales, excise, use, turnover and license taxes) shall be charged to and remitted by Buyer to Seller.
- Financial:** If the financial position of Buyer at any time becomes unsatisfactory to Seller, Seller reserves the right to stop shipments or require satisfactory security or payment in advance. If Buyer fails to make payment or otherwise comply with these Terms or any related agreement, Seller may (without liability and in addition to other remedies) cancel any unshipped portion of Products sold hereunder and stop any Products in transit until Buyer pays all amounts, including amounts payable hereunder, whether or not then due, which are owing to it by Buyer. Buyer shall in any event remain liable for all unpaid accounts.
- Cancellation; Etc:** Orders are not subject to rescheduling or cancellation unless Buyer indemnifies Seller fully against all costs or expenses arising in connection therewith.
- Force Majeure:** Seller shall not be liable for any delay or failure in delivery resulting from causes beyond its control, including earthquakes, fires, floods, strikes or other labor disputes, shortage of labor or materials, accidents to machinery, acts of sabotage, riots, delay in or lack of transportation or the requirements of any government authority.
- Shipping; Delivery:** Unless otherwise expressly agreed in writing by Seller:
 - All sales and shipments of Products shall be FOB shipping point (unless otherwise stated in writing by Seller), at which point title to and all risk of loss of the Products shall pass from Seller to Buyer, provided that Seller shall retain a security interest in the Products until the full purchase price is paid by Buyer;
 - Delivery and shipping dates are estimates only; and
 - Seller will package Products as it deems proper for protection against normal handling and extra charges apply to special conditions.
- Claims:** Any claim by Buyer against Seller for shortage or damage to the Products occurring before delivery to the carrier or any claim related to pricing or other charges must be presented in detail in writing to Seller within 30 days of receipt of shipment.

III. PRECAUTIONS

- Suitability:** IT IS THE BUYER'S SOLE RESPONSIBILITY TO ENSURE THAT ANY OMRON PRODUCT IS FIT AND SUFFICIENT FOR USE IN A MOTORIZED VEHICLE APPLICATION. BUYER SHALL BE SOLELY RESPONSIBLE FOR DETERMINING APPROPRIATENESS OF THE PARTICULAR PRODUCT WITH RESPECT TO THE BUYER'S APPLICATION INCLUDING (A) ELECTRICAL OR ELECTRONIC COMPONENTS, (B) CIRCUITS, (C) SYSTEM ASSEMBLIES, (D) END PRODUCT, (E) SYSTEM, (F) MATERIALS OR SUBSTANCES OR (G) OPERATING ENVIRONMENT. Buyer acknowledges that it alone has determined that the Products will meet their requirements of the intended use in all cases. Buyer must know and observe all prohibitions of use applicable to the Product/s.
- Use with Attention:** The followings are some examples of applications for which particular attention must be given. This is not intended to be an exhaustive list of all possible use of any Product, nor to imply that any use listed may be suitable for any Product:
 - Outdoor use, use involving potential chemical contamination or electrical interference.

- Use in consumer Products or any use in significant quantities.
 - Energy control systems, combustion systems, railroad systems, aviation systems, medical equipment, amusement machines, vehicles, safety equipment, and installations subject to separate industry or government regulations.
 - Systems, machines, and equipment that could present a risk to life or property.
- Prohibited Use:** NEVER USE THE PRODUCT FOR AN APPLICATION INVOLVING SERIOUS RISK TO LIFE OR PROPERTY WITHOUT ENSURING THAT THE SYSTEM AS A WHOLE HAS BEEN DESIGNED TO ADDRESS THE RISKS, AND THAT THE PRODUCT IS PROPERLY RATED AND INSTALLED FOR THE INTENDED USE WITHIN THE OVERALL EQUIPMENT OR SYSTEM.
 - Motorized Vehicle Application:** USE OF ANY PRODUCT/S FOR A MOTORIZED VEHICLE APPLICATION MUST BE EXPRESSLY STATED IN THE SPECIFICATION BY SELLER.
 - Programmable Products:** Seller shall not be responsible for the Buyer's programming of a programmable Product.

IV. WARRANTY AND LIMITATION

- Warranty:** Seller's exclusive warranty is that the Products will be free from defects in materials and workmanship for a period of twelve months from the date of sale by Seller (or such other period expressed in writing by Seller). SELLER MAKES NO WARRANTY OR REPRESENTATION, EXPRESS OR IMPLIED, ABOUT ALL OTHER WARRANTIES, NON-INFRINGEMENT, MERCHANTABILITY OR FITNESS FOR A PARTICULAR PURPOSE OF THE PRODUCTS.
- Buyer Remedy:** Seller's sole obligation hereunder shall be to replace (in the form originally shipped with Buyer responsible for labor charges for removal or replacement thereof) the non-complying Product or, at Seller's election, to repay or credit Buyer an amount equal to the purchase price of the Product; provided that there shall be no liability for Seller or its affiliates unless Seller's analysis confirms that the Products were correctly handled, stored, installed and maintained and not subject to contamination, abuse, misuse or inappropriate modification. Return of any Products by Buyer must be approved in writing by Seller before shipment.
- Limitation on Liability:** SELLER AND ITS AFFILIATES SHALL NOT BE LIABLE FOR SPECIAL, INDIRECT, INCIDENTAL OR CONSEQUENTIAL DAMAGES, LOSS OF PROFITS OR PRODUCTION OR COMMERCIAL LOSS IN ANY WAY CONNECTED WITH THE PRODUCTS, WHETHER SUCH CLAIM IS BASED IN CONTRACT, WARRANTY, NEGLIGENCE OR STRICT LIABILITY. FURTHER, IN NO EVENT SHALL LIABILITY OF SELLER OR ITS AFFILIATES EXCEED THE INDIVIDUAL PRICE OF THE PRODUCT ON WHICH LIABILITY IS ASSERTED.
- Indemnities:** Buyer shall indemnify and hold harmless Seller, its affiliates and its employees from and against all liabilities, losses, claims, costs and expenses (including attorney's fees and expenses) related to any claim, investigation, litigation or proceeding (whether or not Seller is a party) which arises or is alleged to arise from Buyer's acts or omissions under these Terms or in any way with respect to the Products.

V. INFORMATION; ETC.

- Intellectual Property:** The intellectual property embodied in the Products is the exclusive property of Seller and its affiliates and Buyer shall not attempt to duplicate it in any way without the written permission of Seller. Buyer (at its own expense) shall indemnify and hold harmless Seller and defend or settle any action brought against Seller to the extent that it is based on a claim that any Product made to Buyer specifications infringed intellectual property rights of another party.
- Property; Confidentiality:** Notwithstanding any charges to Buyer for engineering or tooling, all engineering and tooling shall remain the exclusive property of Seller. All information and materials supplied by Seller to Buyer relating to the Products are confidential and proprietary, and Buyer shall limit distribution thereof to its trusted employees and strictly prevent disclosure to any third party.
- Performance Data:** Performance data is provided as a guide in determining suitability and does not constitute a warranty. It may represent the result of Seller's test conditions, and the users must correlate it to actual application requirements.
- Change In Specifications:** Product specifications and descriptions may be changed at any time based on improvements or other reasons. It is Seller's practice to change part numbers when published ratings or features are changed, or when significant engineering changes are made. However, some specifications of the Product may be changed without any notice.
- Errors And Omissions:** The information on Seller's website or in other documentation has been carefully checked and is believed to be accurate; however, no responsibility is assumed for clerical, typographical or proofreading errors or omissions.
- Export Controls:** Buyer shall comply with all applicable laws, regulations and licenses regarding (a) export of the Products or information provided by Seller; (b) sale of Products to forbidden or other proscribed persons or organizations; (c) disclosure to non-citizens of regulated technology or information.

VI. MISCELLANEOUS

- Waiver:** No failure or delay by Seller in exercising any right and no course of dealing between Buyer and Seller shall operate as a waiver of rights by Seller.
- Assignment:** Buyer may not assign its rights hereunder without Seller's written consent.
- Law:** These Terms are governed by Illinois law (without regard to conflict of laws). Federal and state courts in Cook County, Illinois have exclusive jurisdiction for any dispute hereunder.
- Amendment:** These Terms constitute the entire agreement between Buyer and Seller relating to the Products, and no provision may be changed or waived unless in writing signed by the parties.
- Severability:** If any provision hereof is rendered ineffective or invalid, such provision shall not invalidate any other provision.

Certain Precautions on Specifications and Use

1. **Suitability for Use.** Seller shall not be responsible for conformity with any standards, codes or regulations which apply to the combination of the Product in Buyer's application or use of the Product. At Buyer's request, Seller will provide applicable third party certification documents identifying ratings and limitations of use which apply to the Product. This information by itself is not sufficient for a complete determination of the suitability of the Product in combination with the end product, machine, system, or other application or use. Buyer shall be solely responsible for determining appropriateness of the particular Product with respect to Buyer's application, product or system. Buyer shall take application responsibility in all cases but the following is a non-exhaustive list of applications for which particular attention must be given:
 - (i) Outdoor use, uses involving potential chemical contamination or electrical interference, or conditions or uses not described in this document.
 - (ii) Energy control systems, combustion systems, railroad systems, aviation systems, medical equipment, amusement machines, vehicles, safety equipment, and installations subject to separate industry or government regulations.
 - (iii) Use in consumer products or any use in significant quantities.
 - (iv) Systems, machines and equipment that could present a risk to life or property. Please know and observe all prohibitions of use applicable to this product.

NEVER USE THE PRODUCT FOR AN APPLICATION INVOLVING SERIOUS RISK TO LIFE OR PROPERTY WITHOUT ENSURING THAT THE SYSTEM AS A WHOLE HAS BEEN DESIGNED TO ADDRESS THE RISKS, AND THAT THE OMRON PRODUCT IS PROPERLY RATED AND INSTALLED FOR THE INTENDED USE WITHIN THE OVERALL EQUIPMENT OR SYSTEM.
2. **Programmable Products.** Seller shall not be responsible for the user's programming of a programmable product, or any consequence thereof.
3. **Performance Data.** Performance data given in this publication is provided as a guide for the user in determining suitability and does not constitute a warranty. It may represent the result of Seller's test conditions, and the users must correlate it to actual application requirements. Actual performance is subject to Seller's Warranty and Limitations of Liability.
4. **Change in Specifications.** Product specifications and accessories may be changed at any time based on improvements and other reasons. It is our practice to change part numbers when published ratings or features are changed, or when significant construction changes are made. However, some specifications of the Product may be changed without any notice. When in doubt, special part numbers may be assigned to fix or establish key specifications for your application. Please consult with your Seller representative at any time to confirm actual specifications of purchased Product.
5. **Errors and Omissions.** The information in this publication has been carefully checked and is believed to be accurate; however, no responsibility is assumed for clerical, typographical or proofreading errors, or omissions.
6. **RoHS Compliance.** Where indicated, our products currently comply, to the best of our knowledge as of the date of this publication, with the requirements of the European Union's Directive on the Restriction of certain Hazardous Substances ("RoHS"), although the requirements of RoHS do not take effect until July 2006. These requirements may be subject to change. Please consult our website for current information.

Complete "Terms and Conditions of Sale" for product purchase and use are on Omron's website at <http://www.components.omron.com> – under the "About Us" tab, in the Legal Matters section.

ALL DIMENSIONS SHOWN ARE IN MILLIMETERS.

To convert millimeters into inches, multiply by 0.03937. To convert grams into ounces, multiply by 0.03527.

OMRON®

**OMRON ELECTRONIC
COMPONENTS LLC**

55 E. Commerce Drive, Suite B
Schaumburg, IL 60173

847-882-2288

OMRON ON-LINE

Global - <http://www.omron.com>

USA - <http://www.components.omron.com>