

ABS400 Series

400 W AC-DC Power Supplies

Sealed IP67

The ABS400 Series of AC-DC power supplies provides up to 400 W of regulated output power through wide input voltage range 90 – 264 VAC in single outputs of 12, 24, 36 or 48 VDC.

The ABS400 Series comes in a 83.0 x 212.0 x 42.0 mm form factor, offering 12 and 5 VSB standby outputs and a full set of protection features. Available control signals include Power Good (Power_OK), remote On/off (PS_ON) and remote sense (+RS).

The sealed and full potted package allows an IP67 ingress protection index and can be installed in contact with thermo-conductive part of the system to transfer heat by conduction.

The ABS400 Series complies with the latest international safety standards for Audio Video and IT equipment and displays the CE-Mark for the European Low Voltage Directive (LVD).

Key Features & Benefits

- Universal input voltage range (90 – 264 V_{AC})
- Input surge current limiting
- 400 W rated power (440 W peak up to 10 s)
- High efficiency up to 94%
- Low stand-by consumption (<0.5 W)
- 12, 24, 36 and 48 V standard output voltages
- Active PFC, EN61000-3-2 compliant (Class C, >25% load).
- Low earth / touch leakage current
- Over temperature protection, OV, OC and SC protections
- Stand by +5 V, 2 A and auxiliary / fan 12 V_{DC}, 1 A outputs.
- Remote On / Off signal
- Power good and remote sense signals
- Sealed, potted package IP67 rated, fits 1U applications
- UL/IEC 60950-1 and UL/IEC 62368-1 safety approval
- RoHS 3 compliant (Directive 2015/863/EU)
- 4000 m altitude operation
- Optional heatsink accessory available (HSKIT-400-XBS)
- Suitable for harsh environments

Applications

- Video Wall Displays
- Entertainment Lighting
- Industrial & Process Control
- Telecommunications
- Laboratory Equipment
- Test & Measurement Equipment
- Class II outdoor signage



bel POWER SOLUTIONS & PROTECTION

a bel group

belfuse.com/power-solutions

1. MODEL SELECTION

MODEL NUMBER	PACKAGE & COOLING	INPUT VOLTAGE RANGE [VAC]	NOM. OUTPUT VOLTAGE [VDC]	MAX. OUTPUT POWER [W]	MAX. OUTPUT CURRENT [A]	DIMENSIONS
ABS400-1012	Sealed Chassis Convection / Conduction	90 - 264	12	400	33.3	Dimensions without heatsink: 83.0 x 212.0 x 42.0 mm 3.27 x 8.34 x 1.65 in
ABS400-1024	Sealed Chassis Convection / Conduction	90 - 264	24	400	16.7	
ABS400-1036	Sealed Chassis Convection / Conduction	90 - 264	36	400	11.1	Dimensions with heatsink: 83.0 x 212.0 x 70.1 mm 3.27 x 8.34 x 2.76 in
ABS400-1048	Sealed Chassis Convection / Conduction	90 - 264	48	400	8.3	
HSKIT-400-XBS	- Heatsink accessory (optional) Mounting kit includes 4x screws, M4x10, and the thermally conductive graphite sheet					

2. INPUT SPECIFICATIONS

PARAMETER	DESCRIPTION / CONDITION	MIN	NOM	MAX	UNIT	
AC Input Voltage	PS starts and operates at 90 V _{AC} at all load conditions	90	100-240	264	V _{RMS}	
DC Input Voltage		170	-	270	V _{DC}	
Input Frequency		47	50/60	440	Hz	
Input Current	RMS at 180 V _{AC} , maximum load, 50 / 60 Hz RMS at 90 V _{AC} , maximum load, 50 / 60 Hz	-	-	2.5 5.0	A	
Inrush Current	265 V _{AC} , 25 °C ambient, cold start.			20	A	
Fusing	2x Time Lag 6.3 A, 250 V on both L and N	-	-	6.3	A	
Efficiency	At 115 V _{AC}	20% rated load	90	-	-	%
		100 % load	92	-	-	
	At 230 V _{AC}	20% full load	90	-	-	
		50 – 100 % full load	94	-	-	
Input Power Consumption	Power on, 115-230 V _{RMS} , no load Stand by, 115-230 V _{RMS} , no load	- -	1 0.4	1.5 0.5	W	
Power Factor	At full rated load, 115 VAC, 60 Hz and 230 VAC, 50 Hz input voltages	0.95	-	-	-	
Harmonic Current Fluctuations and Flicker	Complies with EN-61000-3-2 Class C at 230 VAC 50 Hz, load >50 W. Complies with EN-61000-3-3 at nominal voltages and full load.					
Leakage Current	Normal conditions, 240 V _{RMS} , 60 Hz.			300	µA	

3. OUTPUT SPECIFICATIONS

PARAMETER	DESCRIPTION / CONDITION	MIN	NOM	MAX	UNIT	
V1 Output Voltage	±0.5% set point accuracy on all outputs	-	12	-	V	
		-	24	-		
		-	36	-		
		-	48	-		
V1 Output Power Rating	All models, convection cooling	-	-	350	W	
	All models, conduction cooling / heat sink	-	-	400		
	All models, peak power (≤ 10 s)	-	-	440		
V1 Output Current	* Conduction (with heatsink)	V1: 12 V _{DC}		33.3	A	
		V1: 24 V _{DC}		16.7		
		V1: 36 V _{DC}		11.1		
	** Convection (without heatsink)	V1: 48 V _{DC}		8.3	A	
		V1: 12 V _{DC}		29.2		
		V1: 24 V _{DC}		14.6		
		V1: 36 V _{DC}		9.7		
		V1: 48 V _{DC}		7.3		
V1 Voltage Adjustment Range		±5	-	-	%V1	
V1 Load-Line-Cross Regulation	V _{AC} : 90 – 264 V _{RMS}			±2	%V1	
	V1 Load: 0 – 33.3 A (12 V) 0 – 16.7 A (24 V) 0 – 11.1 A (36 V) 0 – 8.3 A (48 V) V2 Load: 0 – 1 A 5V _{SB} Load: 0 – 2 A					
V1 Line Regulation	V _{AC} : 90 – 264 V _{RMS}	-	-	±0.1	%V1	
Transient Response (Voltage Deviation) V1, 5V _{SB}	25% load changes at 1 A/μs 12 V at 2200 μF Load / I _{OUT} > 0.5 A 24 V at 1000 μF Load / I _{OUT} > 0.5 A 36 V at 820 μF Load / I _{OUT} > 0.5 A 48 V at 560 μF Load / I _{OUT} > 0.5 A 5V _{SB} at 560 μF Load / I _{OUT} > 0.1 A	-	-	±5	%V1 %5V _{SB}	
V1 Ripple & Noise	All models, Peak-to-peak, 20 MHz BW. 100 nF ceramic and 10μF tantalum to the load.	-	-	1	%V1	
Start-up Rise Time	90<V _{IN} <264, any load conditions.	5	-	85	ms	
Start-up Delay	V1 in regulation after PS_ON is asserted	-	-	200	ms	
	V1 in regulation after AC is applied	-	-	750		
	5V _{SB} in regulation after AC is applied	-	-	500		
Turn-on Overshoot	At 500 mA output current, V1 in regulation within 50 ms.	-	10	-	%V1	
		-	10	-	%V2	
		-	10	-	%V _{SB}	
Hold-up Time	At nominal V _{IN} , 400 W, for all outputs	-	16	-	ms	
	At nominal V _{IN} , 365 W, for all outputs	-	20	-		
	At nominal V _{IN} , 200 W, for all outputs	-	35	-		
Minimum Load ***	All models; V1, V2 and 5V _{SB}	0	-	-	A	
Maximum Load Capacitance	At nominal V _{IN} , 25 °C ambient	12 V	-	-	33000	μF
		24 V	-	-	16000	
		36 V	-	-	10000	
		48 V	-	-	7000	
Temperature Drift		-1.2	-	+1.2	mV/°C	
V2 Output Voltage	All versions.				V	
	Load on V2: from 5 to 1000 mA Load on V1: from 0.1 to 16.7 A	11.25	12.5	13.75		
V2 Output Current	All models, convection/forced air cooling	-	-	1	A	
V2 Ripple	Peak-to-Peak measured at 20 MHz Bandwidth.			240	mV	
5V _{SB} Output Voltage	All models (3% set point accuracy)	-	5	-	V	
5V _{SB} Output Current	All models, convection cooling	-	-	1.5	A	
	All models, conduction cooling / heat sink	-	-	2		

5V _{SB} Load-Line-Cross Regulation	V _{AC} : 90 – 264 V _{RMS}	V1 Load: 0 – 33.3 A (12 V)	-	-	±5	%5V _{SB}
		0 – 16.7 A (24 V)				
5V _{SB} Ripple	Peak-to-Peak measured at 20 MHz Bandwidth.	0 – 11.1 A (36 V)	50	mV		
		0 – 8.3 A (48 V)				
		V2 Load: 0 – 1 A 5V _{SB} Load: 0 – 2 A				

- * The combined output power of V1, V2 and 5V_{SB} for all models, when conduction cooled or convection cooled with heat sink mounted, must not exceed 400 W up to 50 °C, and 300 at 70 °C ambient temperature.
- ** The combined output power of V1, V2 and 5 V_{SB} for all models, when convection cooled and V_{IN} ≥ 180 V_{RMS}, must not exceed 350 W up to 50 °C, and 240 W at 70 °C ambient temperature. See de-rating curves below.
- *** When the load on the main output is less than 100 mA, V2 output voltage might regulate below its minimum value. Contact Bel for details.

3.1 OUTPUT POWER DE-RATING CURVES

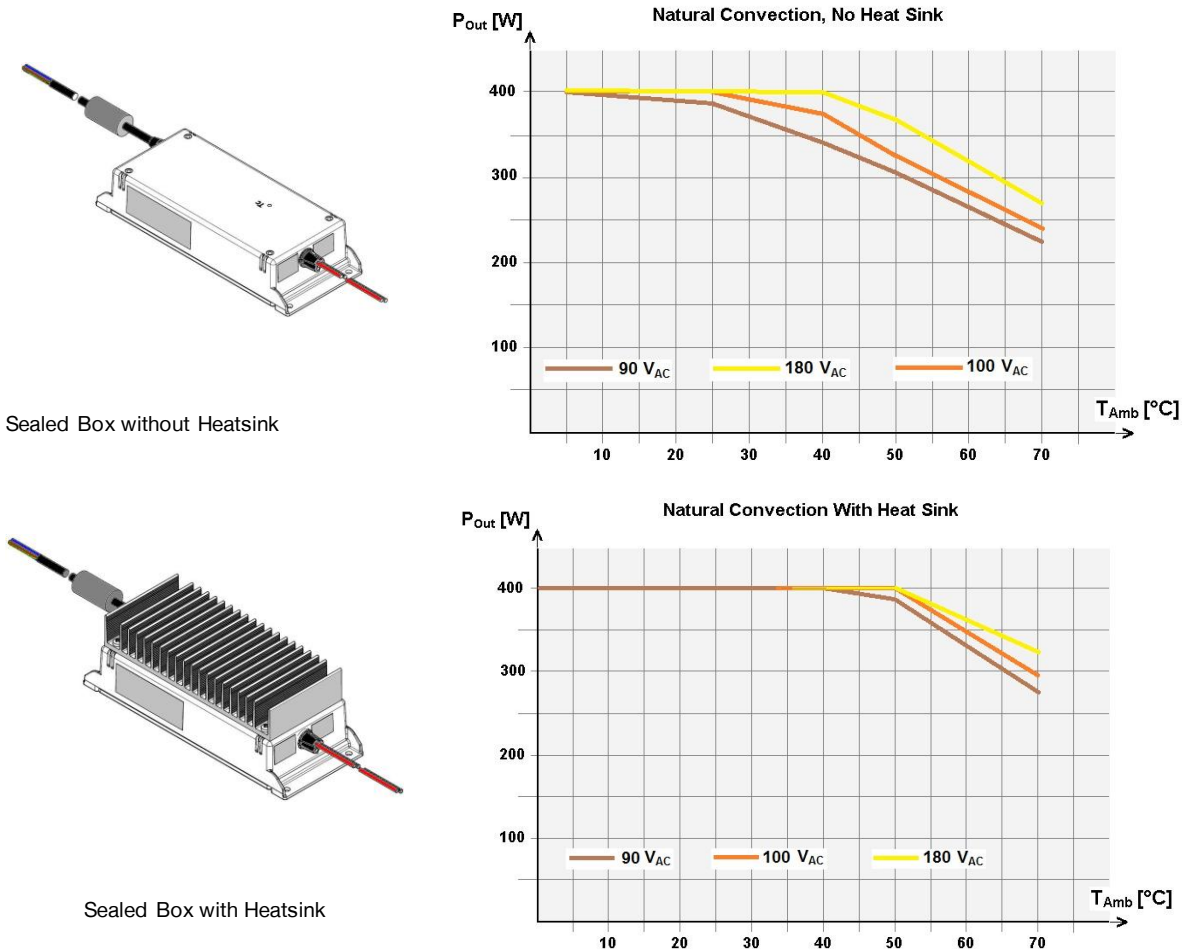
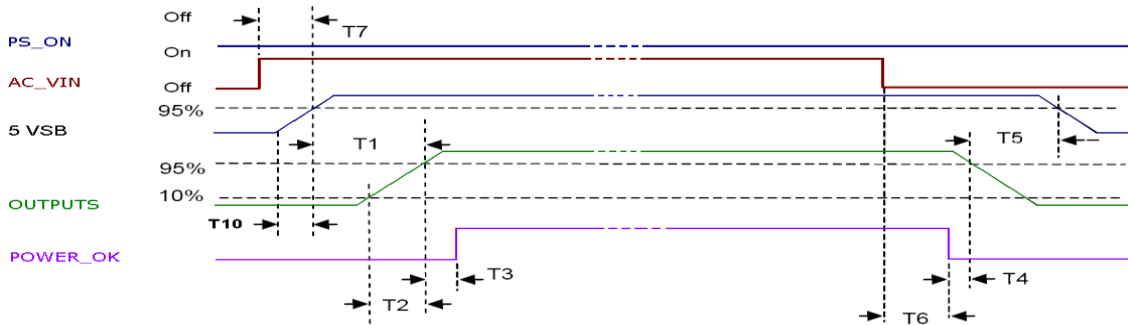

Figure 2. Power Derating Curves

4. SIGNALS, CONTROLS & TIMING SPECIFICATIONS

Base signals and controls are accessible from signal connector P204.

SIGNAL	DESCRIPTION / CONDITION	MIN	NOM	MAX	UNIT
PS_ON	Active low, +5 V TTL signal compatible. Input low voltage	0	-	2.0	V
	Input high voltage ($I_{IN} = 200 \mu A$)	3.0	-	-	V
	V1 and V2 disabled when PS_ON is open				
	5V _{SB} not affected by PS_ON				
	V1 and V2 enabled with PS_ON connected to RTN				
P_OK	+5 V TTL compatible				
	Logic level low (<10 mA sinking)	-	-	0.7	V
	Logic level high (100 μA sourcing)	2.4	-	5	V
	Low to high time after V1 in regulation	0.05	-	0.1	s
	Power down warning time	1	-	-	ms
5V_{SB} output	Active and in regulation after a $90 < V_{AC} < 264$ is applied	-	-	200	ms
	5V _{SB} not affected by PS_ON				



Above waveforms are expected with AC Input ON/OFF:

Standby on - Main outputs on	$50 \text{ ms} \leq T1 \leq 250 \text{ ms}$
Main output Rise Time	$5 \text{ ms} \leq T2 \leq 110 \text{ ms}$
5 V _{SB} rise time	$4 \text{ ms} \leq T10 \leq 20 \text{ ms}$
Main outputs On – P_OK delay	$25 \text{ ms} \leq T3 \leq 100 \text{ ms}$
Power down warning ¹	$T4 \geq 1 \text{ ms}$
Main Output off – Standby off ²	$T5 \geq 1.2 \text{ s}$
Hold-up time (AC off – P_OK low)	$T6 \geq 15 \text{ ms (115/ 230 VAC)}$
AC_ON - Standby turn on time	$T7 \leq 500 \text{ ms}$

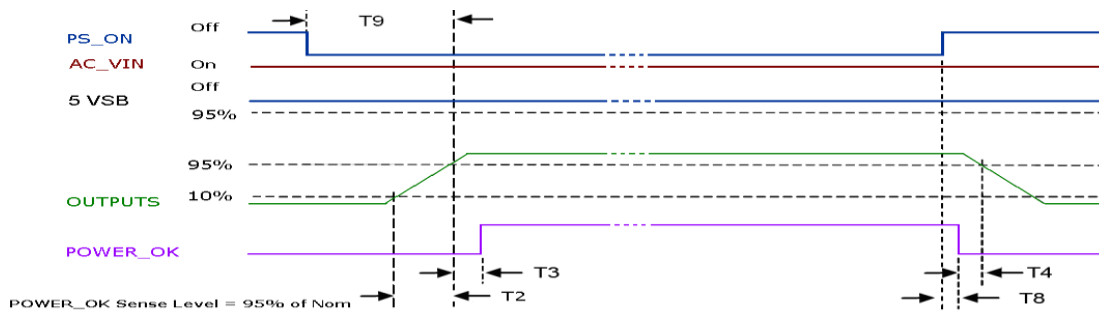

Above waveforms are expected with PS_ON Signal ON/OFF state change:

Main Output Rise Time	$5 \text{ ms} \leq T2 \leq 110 \text{ ms}$
Main Outputs on – P_OK delay	$25 \text{ ms} \leq T3 \leq 100 \text{ ms}$
Power down warning ¹	$1 \text{ ms} \leq T4 \leq 5 \text{ ms}$
PS_ON - Main Output (off) Timing	$T8 \leq 1 \text{ ms}$
PS_ON - Main Output (on) Timing	$T9 \leq 200 \text{ ms}$

¹ T4 parameter measurement setup will assume at least 10% of the maximum load on each output.

² T5 parameter measurement setup will assume 50% of the maximum load on 5V_{SB}.

5. PROTECTION SPECIFICATIONS

PARAMETER	DESCRIPTION / CONDITION	MIN	NOM	MAX	UNIT
Input Under Voltage	Auto-recovering, hiccup mode.	60	75	-	V _{AC}
Input Fuse	2x Time Lag 6.3 A, 250 V on L and N	-	-	6.3	A
Over Current	At nominal input voltages. V1: Hiccup mode, auto-recovering. V2: PTC limiting, auto-recovering. 5V _{SB} : Hiccup mode, auto-recovering.	110	-	155	%I _{MAX}
Short Circuit	At nominal input voltages. V1: Hiccup mode, auto-recovering. V2: PTC limiting, auto-recovering. 5V _{SB} : Hiccup mode, auto-recovering.	-	-	-	
Over Voltage	12V 24V 48V 5V _{SB} Shut down, latch-off.	110	-	136	%V _{NOM}
Over Temperature (on primary stage)	Shut down, latch off.	-	-	-	
Over Temperature (on secondary side)	Hiccup mode, auto-recovering.	-	-	-	
Isolation Primary to Secondary	Reinforced (2x MoPP)	5660	-	-	V _{DC} V _{AC}
Isolation Input to Earth	Basic (1x MoPP)	1500	-	-	V _{AC}
Isolation V1 to V2	Functional	100	-	-	V _{DC}
Isolation Output to Earth	Basic (1x MoPP)	1500	-	-	V _{AC}

6. ENVIRONMENTAL SPECIFICATIONS

PARAMETER	DESCRIPTION / CONDITION	MIN	NOM	MAX	UNIT
Operating Temperature Range	PS starts up at -30 °C See graphs above for output power de-rating against T_{Amb} and V_{in} .	-20	-	70	°C
Storage Temperature Range		-40	-	85	°C
Humidity	RH, Non-condensing Operating Non-operating	-	-	90 95	% %
Operating Altitude		-	-	4000	m
Shock	EN 60068-2-27 Operating: Half sine, 30 g, 18 ms, 3 axes, 6x each (3 positive and 3 negative). Non-Operating: Half sine, 50 g, 11 ms, 3 axes, 6x each (3 positive and 3 negative).				
Vibration	EN 60068-2-64 Operating: Sine, 10 – 500 Hz, 1 g, 3 axes, 1 oct/min., 60 min. Random, 5 – 500 Hz, 0.02 g^2/Hz , 1 g_{RMS} , 3 axes, 30 min. Non-Operating: 5 – 500 Hz, 2.46 g_{RMS} (0.0122 g^2/Hz), 3 axes, 30 min.				
MTBF	Full Load, 120 V_{AC} , 50 °C ambient 70% Duty cycle, Telcordia Issue 1	400000	-	-	Hours
Cooling	Convection with or without heat sink and conduction providing an adequate thermal path between the unit and the external environment. Case hot spot temperature, T_c , should not exceed 90 °C in any working condition.				
Useful Life	Low line range, 200 W, 40 °C ambient, natural convection.	-	4	-	Years

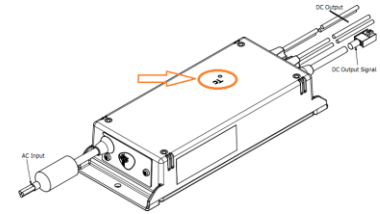

7. ELECTROMAGNETIC COMPATIBILITY (EMC) – EMISSIONS

PARAMETER	DESCRIPTION / CONDITION	STANDARD	PERFORMANCE CLASS
Conducted	115 V_{RMS} , 230 V_{RMS} Maximum load. 4 dB minimum margin	EN 55022 (ITE) EN 55011 (ISM)	B
Radiated	At 10 m distance	EN 55022 (ITE) EN 55011 (ISM)	B
Line Voltage Fluctuation and Flicker	At 20%, 50% and 100% maximum load. Nominal input voltages.	EN 61000-3-3	
Harmonic Current Emission	Nominal input voltages. Output load > 50 W.	EN 61000-3-2	C

8. ELECTROMAGNETIC COMPATIBILITY (EMC) – IMMUNITY

PARAMETER	DESCRIPTION / CONDITION	STANDARD	TEST LEVEL	CRITERIA
	Reference standards for ITE	EN 55024		
ESD	15 kV air discharge, 8 kV contact, at any point of the system.	EN 61000-4-2	4	A
Radiated Field	3 V/m, 80-1000 MHz, 1 KHz/2 Hz 80% AM. Dwell time is 3 sec for 2 Hz modulation Dwell time is 1 sec for 1KHz modulation	EN 61000-4-3	3	A
Electric Fast Transient	±2 kV on AC power port for 1 minute; ±1 kV on signal/control lines	EN 61000-4-4	3	A
Surge	± 2kV line to line; ± 4 KV line to earth; on AC power port; ±0.5 kV for outdoor cables	EN 61000-4-5	3	A B
Conducted RF Immunity	3 V _{RMS} , 0, 15-80 MHz, 1 KHz/2 Hz 80% AM	EN 61000-4-6	3	A
Dips and Interruptions	Dip to 30% for 5 cycle (10 ms)	EN61000-4-11		A
	Dip to 40% for 5 cycles (100 ms)	EN61000-4-11		B
	Dip to 70% for 25 cycles (500 ms)	EN61000-4-11		B
	Drop-out to 5% for 10 ms	EN61000-4-11		B
	Interrupts > 95% for 5 s	EN61000-4-11		B

9. SAFETY AGENCIES APPROVALS

CERTIFICATION BODY	SAFETY STANDARDS	CATEGORY
CSA/UL	CSA C22.2 No. 60950-1, UL 60950-1 and UL 62368-1	Audio Video and Information Technology Equipment
IEC IEC EE CB Certification	IEC/EN 60950-1 and IEC/EN 62368-1	Audio Video and Information Technology Equipment
CE	Low Voltage Directive (LDV) 2006/95/EC	Audio Video and Information Technology Equipment

10. CONNECTIONS AND PIN DESCRIPTION

CONNECTIONS	WIRES GAUGE AND LENGTH	ASSIGNMENT	COLOUR/PIN
AC Input	3x 18 AWG, black external insulation, 300 V, 105°C, UL2517 cord, 310 ± 10 mm extension from grommet.	Live (L)	Brown
		Neutral (N)	Blue
		Protective Earth (PE)	Green Yellow
DC Output	12 V version: 6 x 14 AWG, Style 1015, 600 V, 105°C, 260±10 mm 24, 48 V versions: 4x 14 AWG, Style 1015, 600 V, 105°C, 260±10 mm	3x (2x) +V1 Output (+V1)	Red
		3x (2x) V1 Return (RTN)	Black
Auxiliary Voltages Control Signals	Wires: 8x 22 AWG, black external insulation, 300 V, 105°C, UL2517 cord, 220 ± 10 mm extension from grommet to connector. Housed by Connector: Molex 90142-0008 Terminals: Molex 90119-0109 (Tin plating) Mates with Molex 90130-1106 or equivalent. Terminals: Tin plating termination	+5 V Stand-by Output (+5V _{SB})	Red / 1
		Output Power Good (P_OK)	Green / 2
		- Fan Voltage (-V2)	Brown / 3
		Remote On/Off (PS_ON)	Grey / 4
		+ Terminal Remote Sense (+RS)	Yellow / 5
		Stand-by/Signals Return (RTN)	Blue / 6
		+ Fan Voltage (+V2)	White / 7
		Stand-by/Signals Return (RTN)	Black / 8

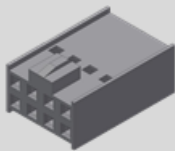

11. MECHANICAL SPECIFICATIONS

PARAMETER	DESCRIPTION / CONDITION
Weight	1300 g (2.87 lb) – without heatsink
	1665 g (3.67 lb) – with heatsink
Overall Dimensions	83.0 x 212.0 x 42.0 mm (3.27 x 8.34 x 1.65 in) - without heatsink
	83.0 x 212.0 x 70.1 mm (3.27 x 8.34 x 2.76 in) - with heatsink

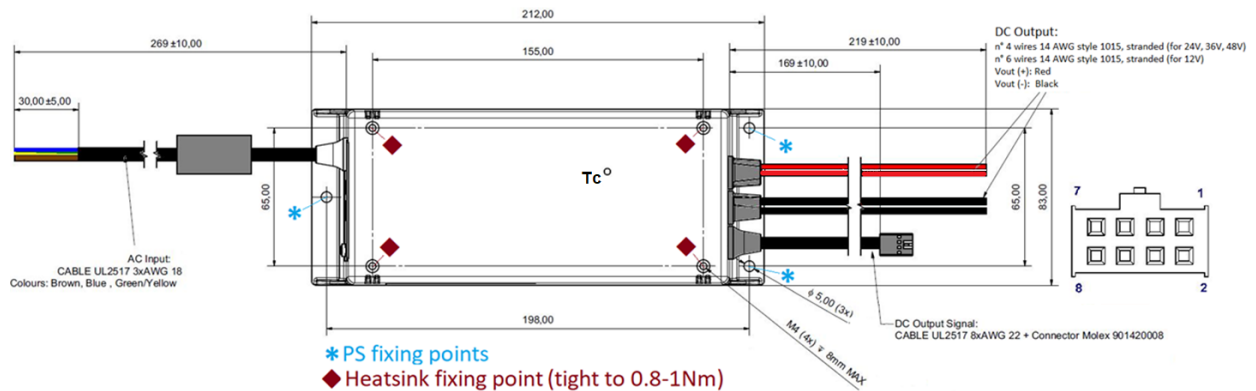
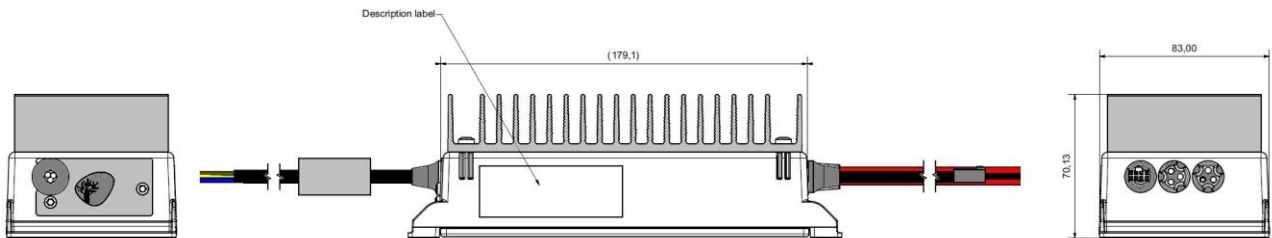
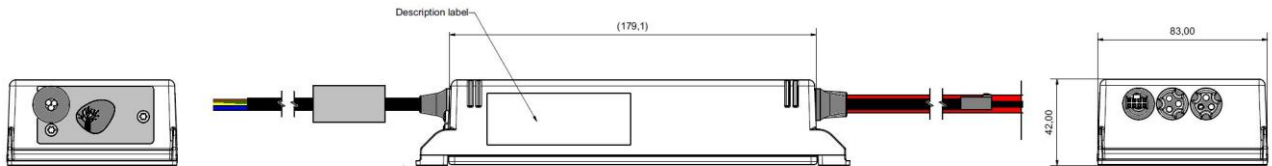

For more information on these products consult: tech.support@psbel.com

NUCLEAR AND MEDICAL APPLICATIONS - Products are not designed or intended for use as critical components in life support systems, equipment used in hazardous environments, or nuclear control systems.

TECHNICAL REVISIONS - The appearance of products, including safety agency certifications pictured on labels, may change depending on the date manufactured. Specifications are subject to change without notice.



Asia-Pacific
+86 755 298 85888

Europe, Middle East
+353 61 225 977

North America
+1 408 785 5200