

# High-end Line Filter for Machinery/Equipment



- Now available up to 600 A
- Compact, space-saving design, optimized for industrial machinery
- Combines exceptional attenuation with low leakage current
- Suitable for machines in mixed/domestic environments (Class A/B)
- Increases also the immunity if operated directly on the mains input



### Performance indicators

Attenuation performance

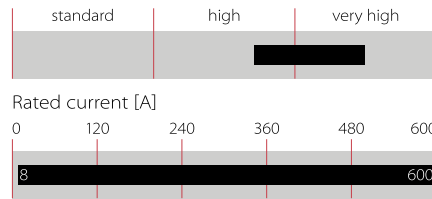

### Approvals & Compliances



### Features and benefits

- A compact and light weight filter design with a „cubic“ shape, requiring minimum mounting space and thus taking the constructional conditions on the mains input of machinery into account
- Simple and time-saving installation with good accessibility for automatic and hand tools
- Solid, touch-safe terminal blocks (8 to 200 A types) offering sufficient contacting cross section according to the EN 60204-1 installation standard, which is very common in industrial applications
- As a mains input filter for three phases and neutral line, FN 3280 provides enough performance to ensure EMC compliance of machinery in mixed (Class A) or even domestic (Class B) environments. Further, its use will also increase the immunity of the entire installation significantly
- FN 3280 provides the attenuation performance needed to meet the requirements of various machine tools with up to 12 driving axes and ~10 to 20 m of motor cable each
- For easy selection and application, the filter current ratings are aligned with common fuse values
- R69 option for easy compliance to IEC 60204-1 (DIN VDE 0113): Suitable for complex machines, where the overall insulation resistance needs to be higher than 1 MOhm.

## Technical specifications

<b>Maximum continuous operating voltage</b>	3x 520/300 VAC (480 VAC + 10% possible)
<b>Operating frequency</b>	DC to 60 Hz
<b>Rated currents</b>	8 to 600 A @ 50°C
<b>High potential test voltage</b>	P/N -> E 2750 VDC for 2 sec P -> P 2250 VDC for 2 sec P -> N 1300 VDC for 2 sec
<b>Protection category</b>	IP 20 (8 to 200 A types) IP 00 (300 to 600 A types)
<b>Overload capability</b>	4x rated current at switch on, 1.5x rated current for 1 minute, once per hour
<b>Temperature range (operation and storage)</b>	-25°C to +100°C (25/100/21)
<b>Flammability corresponding to</b>	UL 94 V-2 or better
<b>Design corresponding to</b>	UL 1283, CSA 22.2 No. 8 1986, IEC/EN 60939
<b>MTBF @ 50°C/400 V (Mil-HB-217F)</b>	>360,000 hours







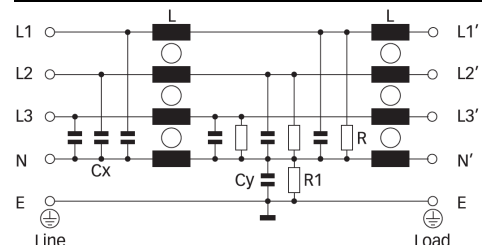



















### Typical applications

Mainly industrial equipment, machinery, machine tools and diverse process automation systems with three-phase and neutral electricity supply. Due to the outstanding attenuation performance, FN 3280 is also the first choice for noisy power supplies, renewable energy applications, highpower office equipment and further three-phase and neutral devices. Because of the relatively low leakage current, FN 3280 may even be used for some medical devices.

### Typical electrical schematic



### Filter selection table

Filter	Buy	Rated current	Leakage current*	Power loss	Resistance**	Resistance**	Input/Output connections		Weight
		@ 50°C (40°C)	@ 520 VAC/50 Hz	@ 25°C/50 Hz	R	R1			
		[A]	[mA]	[W]	[kOhm]	[kOhm]			[kg]
FN3280H-8-29		8 (8.8)	10.7	2.7	1500	660	-29		0.8
FN3280H-16-29		16 (17.5)	10.7	6.0	1500	660	-29		0.8
FN3280H-25-33		25 (27)	10.7	11.6	820	660	-33		1.3
FN3280H-36-33		36 (39)	10.7	14.8	820	660	-33		1.6
FN3280H-64-34		64 (70)	10.7	18.4	820	660	-34		2.7
FN3280H-80-35		80 (88)	10.7	18.9	1000	660	-35		4.1
FN3280H-120-35		120 (131)	10.7	28.5	1000	660	-35		5.9
FN3280H-160-40		160 (175)	10.7	30.7	1000	660	-40		7.9
FN3280H-200-40		200 (219)	10.7	46.8	1000	660	-40		8.5
FN3280H-300-99		300 (328)	42.1	20.3	1000	680		-99	10.0
FN3280H-400-99		400 (438)	42.1	36.0	1000	680		-99	10.0
FN3280H-600-99		600 (657)	42.1	64.8	1000	680		-99	11.0
FN3280H-8-29-R69		8 (8.8)	10.7	2.7	1500	10000	-29		0.8
FN3280H-16-29-R69		16 (17.5)	10.7	6.0	1500	10000	-29		0.8
FN3280H-25-33-R69		25 (27)	10.7	11.6	1500	10000	-33		1.3
FN3280H-36-33-R69		36 (39)	10.7	14.8	1500	10000	-33		1.6
FN3280H-64-34-R69		64 (70)	10.7	18.4	1500	10000	-34		2.7
FN3280H-80-35-R69		80 (88)	10.7	18.9	1500	10000	-35		4.1
FN3280H-120-35-R69		120 (131)	10.7	28.5	1500	10000	-35		5.9
FN3280H-160-40-R69		160 (175)	10.7	30.7	1500	10000	-40		7.9
FN3280H-200-40-R69		200 (219)	10.7	46.8	1500	10000	-40		8.5
FN3280H-300-99-R69		300 (328)	42.1	20.3	1500	10000		-99	10.0
FN3280H-400-99-R69		400 (438)	42.1	36.0	1500	10000		-99	10.0
FN3280H-600-99-R69		600 (657)	42.1	64.8	1500	10000		-99	11.0

\* Standardized calculated leakage current acc. IEC60939 under normal operating conditions.

\*\* Tolerances apply: Inductance: -30/+50%, Capacitance: ±20%, Resistance: ±10%

### Typical filter attenuation

Per CISPR 17; A=50 Ω/50 Ω sym; B=50 Ω/50 Ω asym; C=0.1 Ω/100 Ω sym; D=100 Ω/0.1 Ω sym

8 and 16 A types

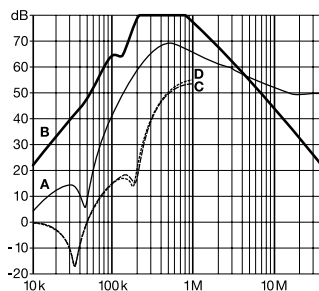

25 and 36 A types

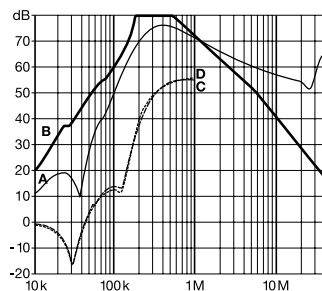

64 to 120 A types

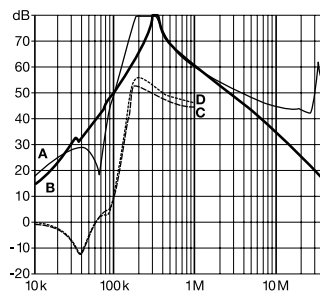

160 and 200 A types

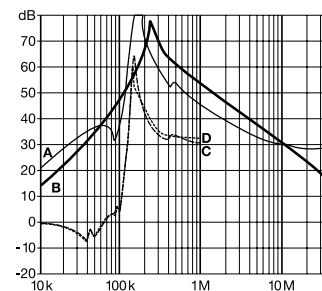

300 to 600 A types

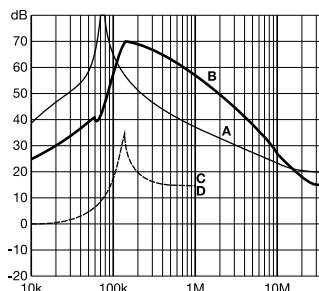

[Check distribution inventory](#)



### Mechanical data

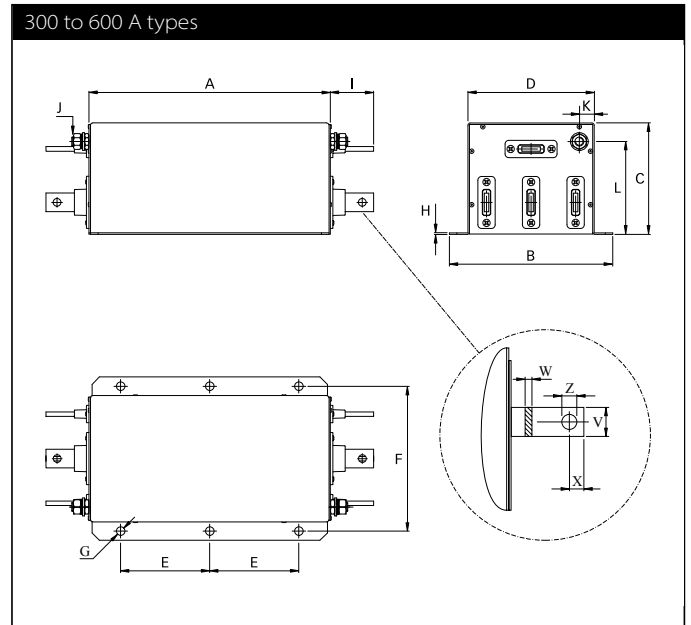
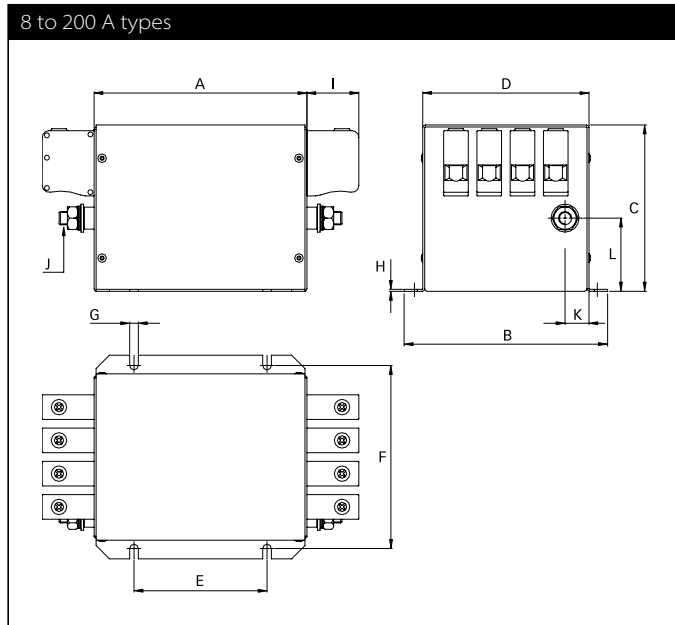

### Dimensions

	8 A	16 A	25 A	36 A	64 A	80 A	120 A	160 A	200 A	300 A	400 A	600 A
<b>A</b>	120	120	130	130	160	230	250	280	280	325	325	325
<b>B</b>	143	143	153	153	153	163	170	170	170	220	220	220
<b>C</b>	80	80	115	115	125	125	140	170	170	150	150	150
<b>D</b>	115	115	125	125	125	135	140	140	140	170	170	170
<b>E</b>	80	80	90	90	100	120	200	230	230	120	120	120
<b>F</b>	127.5	127.5	137.5	137.5	137.5	147.5	153.5	153.5	153.5	195	195	195
<b>G</b>	6.5	6.5	6.5	6.5	6.5	6.5	6.5	6.5	6.5	12	12	12
<b>H</b>	1	1	1	1	1.5	1.5	1.5	1.5	1.5	2	2	2
<b>I</b>	10.9	10.9	25	25	39	45	45	51	51	58	58	58
<b>J</b>	M6	M6	M6	M6	M10	M10	M10	M10	M10	M12	M12	M12
<b>K</b>	12	12	12	12	18	18	17.5	17.5	17.5	20	20	20
<b>L</b>	33	33	50	50	55	45	55	55	55	125	125	125
<b>V</b>										25	25	25
<b>W</b>										6	6	8
<b>X</b>										15	15	15
<b>Z</b>										Ø10.5	Ø10.5	Ø10.5

All dimensions in mm; 1 inch = 25.4 mm  
Tolerances according to: ISO 2768-m/EN 22768-m

### Filter input/output connector cross sections

	-29	-33	-34	-35	-40
<b>Solid wire</b>	6 mm <sup>2</sup>	16 mm <sup>2</sup>	35 mm <sup>2</sup>	50 mm <sup>2</sup>	95 mm <sup>2</sup>
<b>Flex wire</b>	4 mm <sup>2</sup>	10 mm <sup>2</sup>	25 mm <sup>2</sup>	50 mm <sup>2</sup>	95 mm <sup>2</sup>
<b>AWG type wire</b>	AWG 10	AWG 6	AWG 2	AWG 1/0	AWG 4/0
<b>Recommended torque</b>	0.6-0.8 Nm	1.5-1.8 Nm	4.0-4.5 Nm	7-8 Nm	17-20 Nm

Please visit [www.schaffner.com](http://www.schaffner.com) to find more details on filter connectors.



## Headquarters, global innovation and development

### Switzerland

#### Schaffner Group

Industrie Nord  
Nordstrasse 11e  
4542 Luterbach  
T +41 32 681 66 26  
[info@schaffner.com](mailto:info@schaffner.com)



## Sales and application centers

### China

#### Schaffner EMC Ltd. Shanghai

T20-3 C, No 565 Chuangye Road,  
Pudong district  
201201 Shanghai  
T +86 21 3813 9500  
[cschina@schaffner.com](mailto:cschina@schaffner.com)  
[www.schaffner.com.cn](http://www.schaffner.com.cn)

### Finland

#### Schaffner Oy

Sauvonrinne 19 H  
08500 Lohja  
T +358 50 468 7284  
[finlandsales@schaffner.com](mailto:finlandsales@schaffner.com)

### France

#### Schaffner EMC S.A.S.

16-20 Rue Louis Rameau  
95875 Bezons  
T +33 1 34 34 30 60  
F +33 1 39 47 02 28  
[francesales@schaffner.com](mailto:francesales@schaffner.com)

### Germany

#### Schaffner Deutschland GmbH

Schoemperlenstrasse 12B  
76185 Karlsruhe  
T +49 721 56910  
[germanysales@schaffner.com](mailto:germanysales@schaffner.com)

### India

#### Schaffner India Pvt. Ltd

REGUS WORLD TRADE CENTRE  
WTC, 22nd Floor Unit No 2238, Brigade  
Gateway Campus, 26/1, Dr. Rajkumar Road  
Malleshwaram (W)  
560055 Bangalore  
T +91 80 67935355  
[indiasales@schaffner.com](mailto:indiasales@schaffner.com)

### Italy

#### Schaffner EMC S.r.l.

Via Ticino, 30  
20900 Monza (MB)  
T +39 039 21 41 070  
[italysales@schaffner.com](mailto:italysales@schaffner.com)

### Japan

#### Schaffner EMC K.K.

Taiju-Seimei Sangenjaya Bldg.  
1-32-12, Kamiyuma, Setagaya-ku  
154-0011 Tokyo  
T +81 3 5712 3650  
F +81 3 5712 3651  
[japansales@schaffner.com](mailto:japansales@schaffner.com)  
[www.schaffner.jp](http://www.schaffner.jp)

### Singapore

#### Schaffner EMC Pte Ltd.

#05-09, Kg Ubi Ind. Estate  
408705 Singapore  
T +65 6377 3283  
F +65 6377 3281  
[singaporesales@schaffner.com](mailto:singaporesales@schaffner.com)

### Spain

#### Schaffner EMC España

Calle Caléndula 93, Miniparc III, Edificio E  
El Soto de Moraleja, Alcobendas  
28109 Madrid  
T +34 917 912 900  
F +34 917 912 901  
[spainsales@schaffner.com](mailto:spainsales@schaffner.com)

### Sweden

#### Schaffner EMC AB

Östermalmstorg 1  
114 42 Stockholm  
T +46 8 5050 2425  
[swedensales@schaffner.com](mailto:swedensales@schaffner.com)  
[www.schaffner.com](http://www.schaffner.com)

### Switzerland

#### Schaffner EMV AG

Industrie Nord  
Nordstrasse 11e  
4542 Luterbach  
T +41 32 681 66 88  
T +41 32 681 66 26  
[switzerlandsales@schaffner.com](mailto:switzerlandsales@schaffner.com)

### Taiwan

#### Schaffner EMV Ltd.

20 Floor-2, No 97, Section 1, XinTai 5th Road  
22175 XiZhi District New Taipei City 22175  
T +886 2 2697 5500  
F +886 2 2697 5533  
[taiwansales@schaffner.com](mailto:taiwansales@schaffner.com)  
[www.schaffner.com.tw](http://www.schaffner.com.tw)

### Thailand

#### Schaffner EMC Co. Ltd.

Northern Region Industrial Estate  
67 Moo 4 Tambon Ban Klang  
Amphur Muangng P.O. Box 14  
51000 Lamphun  
T +66 53 58 11 04  
F +66 53 58 10 19  
[thailandsales@schaffner.com](mailto:thailandsales@schaffner.com)

### United Kingdom

#### Schaffner Ltd.

1, Oakmede Place  
Binfield  
RG42 4JF Berkshire  
T +44 118 9770070  
F +44 118 9792969  
[uksales@schaffner.com](mailto:uksales@schaffner.com)

### USA

#### Schaffner EMC Inc.

52 Mayfield Avenue  
Edison, New Jersey  
T +1 732 225 9533  
F +1 732 225 4789  
[usasales@schaffner.com](mailto:usasales@schaffner.com)  
[www.schaffnerusa.com](http://www.schaffnerusa.com)

To find your local partner within Schaffner's global network: [www.schaffner.com](http://www.schaffner.com)

© 2021 Schaffner Group

The content of this document has been carefully checked and understood. However, neither Schaffner nor its subsidiaries assume any liability whatsoever for any errors or inaccuracies of this document and the consequences thereof. Published specifications are subject to change without notice. Product suitability for any area of application must ultimately be determined by the customer. In all cases, products must never be operated outside their published specifications. Schaffner does not guarantee the availability of all published products. This disclaimer shall be governed by substantive Swiss law and resulting disputes shall be settled by the courts at the place of business of Schaffner Holding AG. Latest publications and a complete disclaimer can be downloaded from the Schaffner website. All trademarks recognized.