

ExaMAX[®]

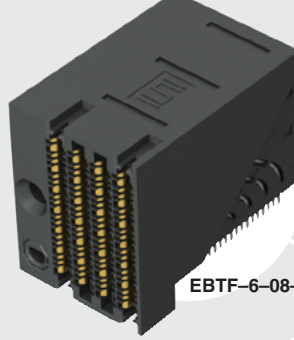

EBTF-6-08-2.0-S-RA-1-L-A



EBTF-4-08-2.0-S-RA-1

(2.00 mm) .0787"

ExaMAX[®] BACKPLANE SYSTEM

SPECIFICATIONS

For complete specifications and recommended PCB layouts see www.samtec.com?EBTF-RA

Insulator Material:

Liquid Crystal Polymer

Contact Material:

Copper Alloy

Plating:

Sn or Au over

50 μm (1.27 μm) Ni

Operating Temp Range:

-55 °C to +85 °C

Current Rating:

4.2 A per pin

(1 pin powered)

Contact Wipe:

2.4 mm

RoHS Compliant:

Yes

Mates with:
EBTM, EBDM

2.00 mm
column pitch

Press-fit
termination

PAM 4

56
G b p s

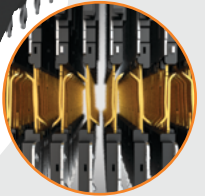
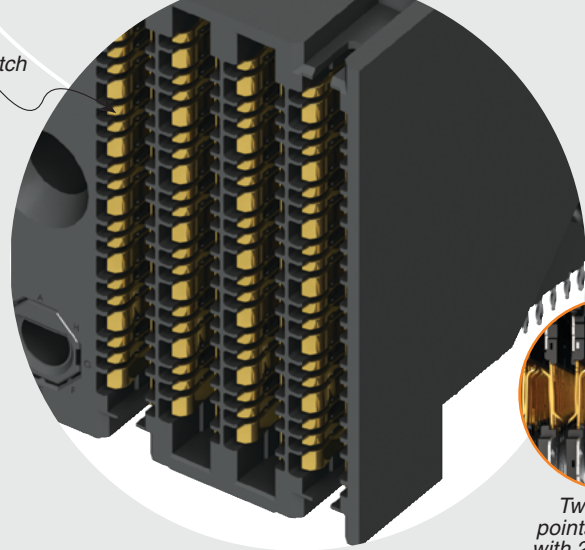

Two reliable
points of contact
with 2.4 mm wipe

RECOGNITIONS

For complete scope of recognitions see www.samtec.com/quality



FILE NO. E111594

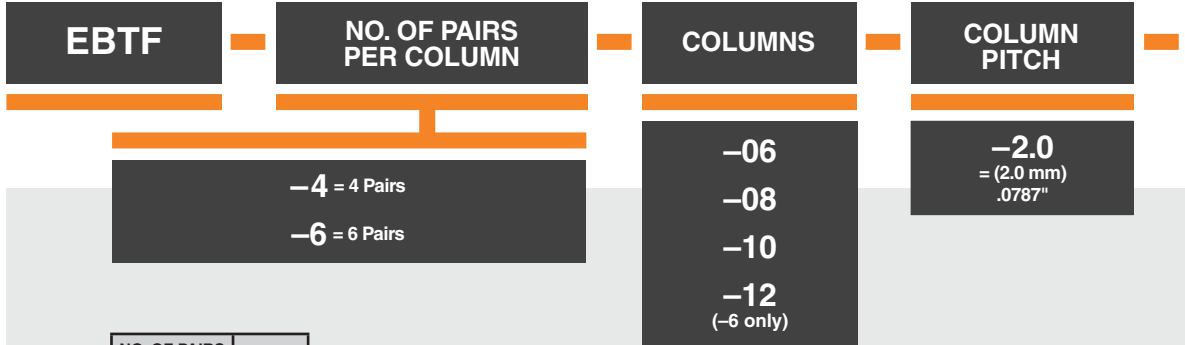

ALSO AVAILABLE (MOQ Required)

- Staging

TOOLING

- For press-fit extraction and insertion tool options, visit www.samtec.com/tooling

NO. OF PAIRS PER COLUMN	B
-4	(22.50) .886
-6	(29.70) 1.169

COLUMNS	A	C
-06	(12.90) .508	(18.85) .742
-08	(16.90) .665	(22.85) .900
-10	(20.90) .823	(26.85) 1.057
-12	(24.90) .980	(30.85) 1.215

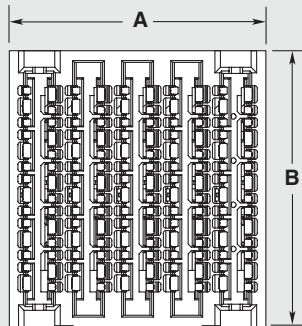

NO GUIDANCE SHOWN

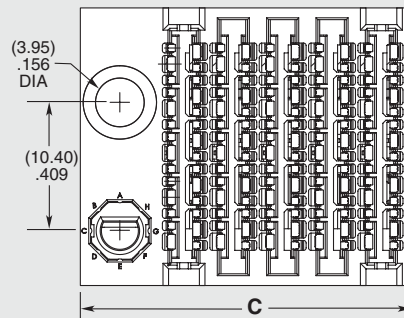

WITH GUIDANCE SHOWN

Notes:

Some lengths, styles and options are non-standard, non-returnable.

ExaMAX[®] is a registered trademark of AFCL.

Due to technical progress, all designs, specifications and components are subject to change without notice.

WWW.SAMTEC.COM

All parts within this catalog are built to Samtec's specifications.

Customer specific requirements must be approved by Samtec and identified in a Samtec customer-specific drawing to apply.

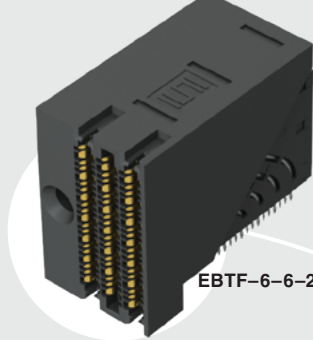

EBTF-6-6-2.0-S-RA-1-L

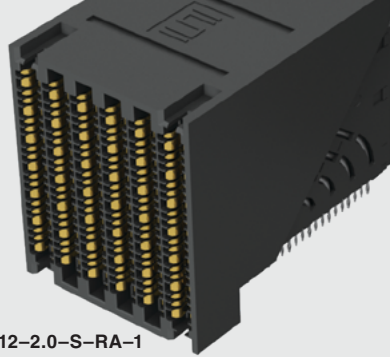

EBTF-6-12-2.0-S-RA-1

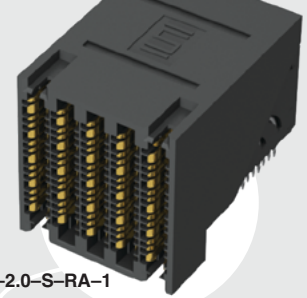

EBTF-4-10-2.0-S-RA-1

EBTF-RA SERIES

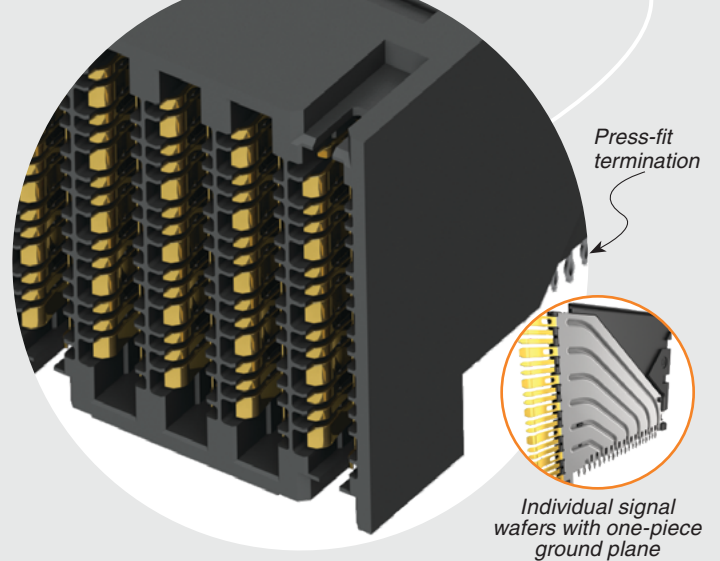
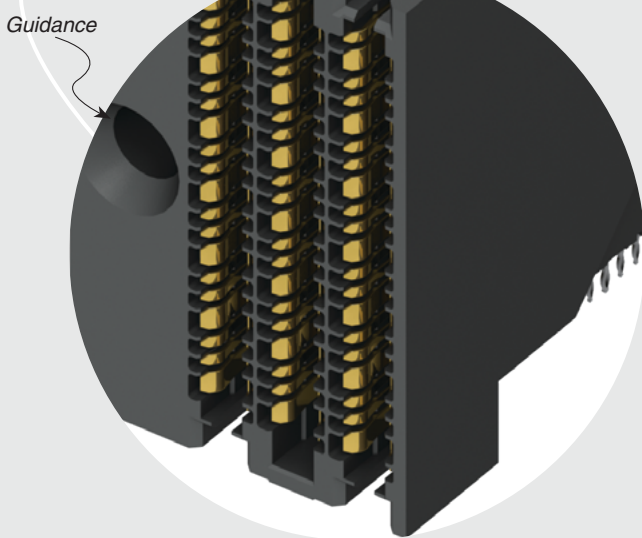

PLATING

RA

1

GUIDANCE

KEYING

-S
= 30 μm (0.76 μm) Gold on contact area,
Matte Tin on tail

(Leave Blank for no Guidance)

(Only available with -L or -R guidance)
(Leave Blank for no keying)

-L
= Left Guidance

-A thru -H
= Position of flat on Key
(See table for Key)

-R
= Right Guidance

GUIDANCE	KEYING							
	-A	-B	-C	-D	-E	-F	-G	-H
-R /-L								

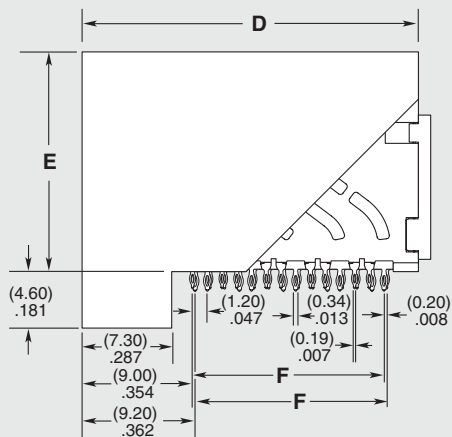

EBTF-4-10-2.0-S-RA-1-L-A SHOWN

APPLICATION



NO. OF PAIRS PER COLUMN	D	E	F
-4	(28.40) 1.118	(17.90) .705	(15.60) .614
-6	(35.60) 1.402	(25.10) .988	(22.80) .898

Due to technical progress, all designs, specifications and components are subject to change without notice.

WWW.SAMTEC.COM

All parts within this catalog are built to Samtec's specifications.
Customer specific requirements must be approved by Samtec and identified in a Samtec customer-specific drawing to apply.