

# Specification

- Part No. : **FMA359.A.LBFCG.001**
- Product Name : Steedan 5-in-1 Magnetic Mount Antenna with GNSS, LTE & FirstNet, 2\*Wi-Fi
- Features : Low Profile Magnetic Mount Enclosure  
1\*LTE 698-960MHz / 1710-2170MHz / 2490-2690MHz / 3300-3600MHz  
1\*FirstNet Band 14  
2\* Wi-Fi MIMO 2.4GHz/5.8GHz  
1\* GPS-GLONASS-GALILEO-BeiDou Antenna  
IP67 Rated, Ruggedized PC/ABS Enclosure  
LTE & FirstNet: 3M TGC200 Cable and SMA(M)ST Connector  
Wi-Fi: 3M TGC200 Cable and RP SMA(M)ST Connector  
GNSS: 3M RG-174 Cable and SMA(M)ST Connector  
Dimensions: 247 \* 144.3 \* 47.8 mm

**RoHS Compliant**



## 1. Introduction

The Taoglas Steedan Scout FMA359 is a 5-in-1 next-generation low profile magnetic mount antenna for vehicle, outdoor building and heavy equipment roof applications. It has a fully IP67 rated waterproof robust ABS enclosure and base. This is an ideal external combination antenna solution that is used where drilling a hole through the roof of a vehicle or a metal panel is not feasible. It can be mounted on steel surfaces and its ultra-strong neodymium magnets. A soft foam cushion on the base protects the mounting surface during installation and removal. Only 48mm high it mounts discretely to the target application out of sight of most onlookers.

This outstanding antenna delivers powerful antenna technology for LTE (2G/3G/4G) and Wi-Fi 2.4/5.8GHz and a custom tuned GPS/GLONASS/BeiDou patch antenna for GNSS location services. The 5 internal antennas have superior isolation. The LTE antenna also includes backward compatibility to work at most worldwide 3G and 2G bands.

This antenna has been optimized for use in FirstNet Applications. FirstNet is a dedicated communications tool for First Responders in the US. It is an isolated network to provide faster critical information and data-sharing between First Responders and their agencies.

### Typical Applications:

- Next Generation OEM Automotive Connectivity
- Multimedia, Navigation and Telematics Systems
- V2V, V2X and Fleet Management Applications
- Real-time HD Video Streaming
- Digital Signage and Remote Monitoring
- FirstNet Responder Routers

FirstNet is a dedicated communications tool for First Responders in the US. It is an isolated network to provide faster critical information and data-sharing between First Responders and their agencies. New FirstNet devices are being deployed to allow for the multitude of services and applications which will be using the network for the following mission critical applications:

- Computer-aided dispatch (vehicle location)
- EMS Electronic Patient Care Reporting
- Vehicle Mounted RMS/ Citations/ Scanners

- Video Streaming

The Steedan is ideal for applications that require highly sophisticated antennas for real-time streaming applications that demand high-speed video uplink and downlink into the cabin of the vehicle. These challenges are resolved by the highly efficient, high gain MIMO antennas, with high isolation, all of which is necessary to achieve the required signal to noise ratio and throughput.

The Steedan can also be customized for your particular wireless application and frequency band, subject to NRE and MOQ. There are 5x 3000mm low loss TGC-200 cables, terminating in SMA(M) connectors for LTE & FirstNet, and RP-SMA(M) for Wi-Fi MIMO. There is a 3000mm RG-174 cable for GNSS terminating in an SMA(M) connector. All cable lengths and connector types are customizable. Contact your regional Taoglas sales office for support.

## 2. Specification

### LTE MIMO1 & MIMO 2 on 30x30cm Ground Plane

LTE Antenna								
Frequency (MHz)		LTE700	GSM850	GSM900	DCS	PCS	UMTS1	LTE2600
		698~824	824~894	880~960	1710~1880	1850~1990	1920~2170	2490~2690
Efficiency (%)								
MIMO1	0.3M	42.71	66.20	69.35	54.36	60.18	62.55	65.55
	1M	40.51	63.21	66.22	49.56	54.89	57.63	59.78
	2M	37.81	57.93	60.39	44.17	48.52	50.52	51.94
	3M	34.94	53.80	56.13	39.27	42.70	44.65	45.22
	5M	32.30	49.97	52.18	34.91	37.59	39.46	39.38
MIMO2	0.3M	43.39	46.55	42.78	49.60	48.61	54.25	64.76
	1M	41.10	44.44	40.85	45.25	44.32	49.96	59.06
	2M	38.35	40.72	37.26	40.33	39.16	43.81	51.32
	3M	35.53	37.83	34.62	35.87	34.48	38.70	44.67
	5M	32.91	35.14	32.17	31.90	30.36	34.19	38.90
Average Gain (dB)								
MIMO1	0.3M	-3.70	-1.79	-1.59	-2.65	-2.21	-2.04	-1.83
	1M	-3.92	-1.99	-1.79	-3.05	-2.61	-2.39	-2.23
	2M	-4.22	-2.37	-2.19	-3.55	-3.14	-2.97	-2.85
	3M	-4.57	-2.69	-2.51	-4.06	-3.70	-3.50	-3.45
	5M	-4.91	-3.01	-2.82	-4.57	-4.25	-4.04	-4.05
MIMO2	0.3M	-3.63	-3.32	-3.69	-3.05	-3.13	-2.66	-1.89
	1M	-3.86	-3.52	-3.89	-3.44	-3.53	-3.01	-2.29
	2M	-4.16	-3.90	-4.29	-3.94	-4.07	-3.58	-2.90
	3M	-4.49	-4.22	-4.61	-4.45	-4.62	-4.12	-3.50
	5M	-4.83	-4.54	-4.93	-4.96	-5.18	-4.66	-4.10
Peak Gain (dBi)								
MIMO1	0.3M	-2.30	-1.57	-1.14	-2.48	-1.83	-1.76	-1.29
	1M	-2.50	-1.77	-1.34	-2.88	-2.23	-2.14	-1.69
	2M	-2.80	-2.17	-1.74	-3.38	-2.83	-2.66	-2.30
	3M	-3.20	-2.47	-2.04	-3.88	-3.33	-3.24	-2.94
	5M	-3.60	-2.77	-2.34	-4.38	-3.83	-3.74	-3.54
MIMO2	0.3M	-2.42	-2.86	-3.13	-2.62	-2.51	-1.80	-1.10
	1M	-2.72	-3.06	-3.33	-3.02	-2.91	-2.20	-1.50
	2M	-3.02	-3.46	-3.73	-3.52	-3.51	-2.70	-2.10
	3M	-3.32	-3.76	-4.13	-4.02	-4.01	-3.30	-2.70
	5M	-3.62	-4.06	-4.45	-4.52	-4.51	-3.90	-3.30
Impedance	50 Ω							
Polarization	Linear							



### WI-FI\_MIMO1 and MIMO2\_On 30x30cm Ground Plane

Wi-Fi Antenna (2.4GHz/5.8GHz)			
Frequency (MHz)		2400~2500	4900~5850
Efficiency (%)			
MIMO1	0.3M	64.14	52.70
	1M	58.48	45.39
	2M	50.93	36.79
	3M	44.36	29.79
	5M	38.64	24.13
MIMO2	0.3M	44.33	57.67
	1M	40.43	49.64
	2M	35.21	40.23
	3M	30.67	32.57
	5M	26.71	26.37
Average Gain (dB)			
MIMO1	0.3M	-1.93	-2.78
	1M	-2.33	-3.43
	2M	-2.93	-4.34
	3M	-3.53	-5.26
	5M	-4.13	-6.17
MIMO2	0.3M	-3.53	-2.39
	1M	-3.93	-3.04
	2M	-4.53	-3.95
	3M	-5.13	-4.87
	5M	-5.73	-5.79
Peak Gain (dBi)			
MIMO1	0.3M	-1.67	-1.95
	1M	-2.07	-2.55
	2M	-2.67	-3.45
	3M	-3.27	-4.34
	5M	-3.87	-5.14
MIMO2	0.3M	-2.82	-1.65
	1M	-3.22	-2.35
	2M	-3.82	-3.25
	3M	-4.42	-4.15
	5M	-5.02	-5.05
Impedance	50 Ω		
Return loss	< -6 dB		
Polarization	Linear		

GNSS ELECTRICAL			
Frequency	GPS L1: 1575.42 MHz ± 1.023 MHz GLONASS L1: 1602 MHz ± 1.023 MHz		
Bandwidth - Return Loss <-10 dB	6 MHz min		
Return loss (GPS L1 GLONASS L1)	< -10 dB		
Passive Gain at Zenith (GPS L1 and GLONASS L1)	+1.0 dBic typ.		
Polarization	RHCP		
Impedance	50 Ω		
LNA Out-band Attenuation	fo = 1575.42MHz fo ± 30 MHz 5dB Min. fo ± 50 MHz 20dB Min. fo ± 100 MHz 25dB Min.		
Input Voltage	Min: 1.8V	Typ. 3.0V	Max: 5.5V
Total Gain @ Zenith	25dBic	30dBic	32dBic
Current Consumption	6mA	12mA	30mA
Noise Figure	2.7dB	3.0dB	3.7dB

<b>MECHANICAL</b>	
Dimensions	247*144.3*47.78 mm
Cable	LTE & FirstNet: 3000mm TGC200 Wi-Fi MIMO & 2: 3000mm TGC200 GNSS: 3000mm RG174
Connector	LTE: SMA(M) Wi-Fi: RP SMA(M) GNSS: SMA(M)
Casing	PC+ABS
Adhesive	3M 9448HK + CR4305
Sealant	Rubber Stopper
Weight	550 g
<b>ENVIRONMENTAL</b>	
Protection	IP67
Corrosion	5% NaCl for 96hrs - Nickel plated steel base and thread
Temperature Range	-40°C to +85°C
Thermal Shock	100 cycles -40°C to +85°C
Humidity	Non-condensing 65°C 95% RH
Shock (Drop Test)	1m drop on concrete 6 axes
Cable Pull	8 Kgf
Recommended Mounting Torque	24.5N·m
Maximum Mounting Torque	29.5N·m



### 3. Antenna Characteristics

#### 3.1. LTE MIMO1 and MIMO2 Antennas

##### 3.1.1. Return Loss – LTE MIMO1 and MIMO2

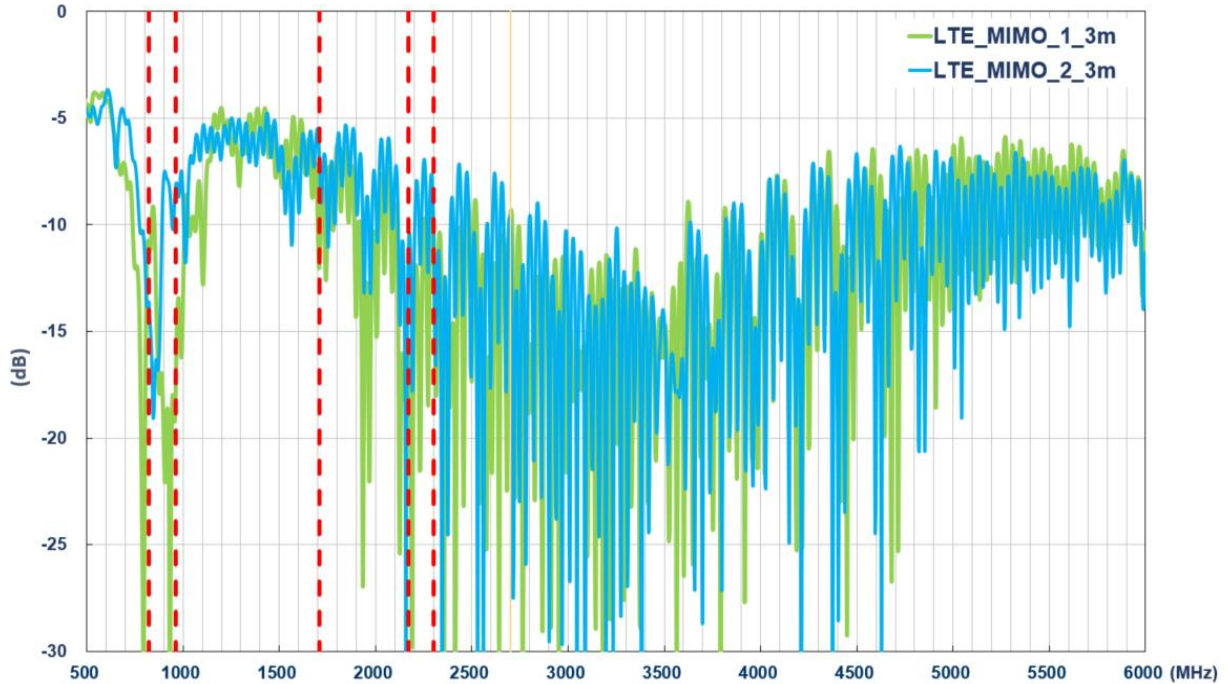

##### 3.1.2. Efficiency – LTE MIMO1 and MIMO2

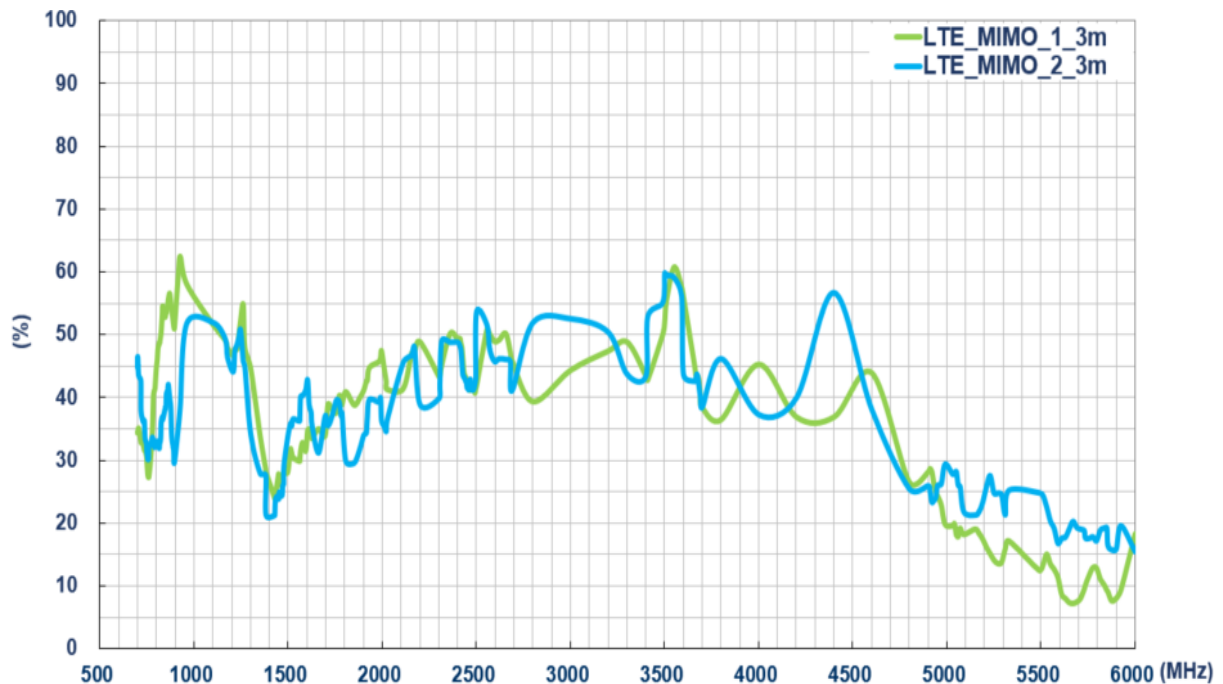

### 3.1.3. Average Gain – LTE MIMO1 and MIMO2

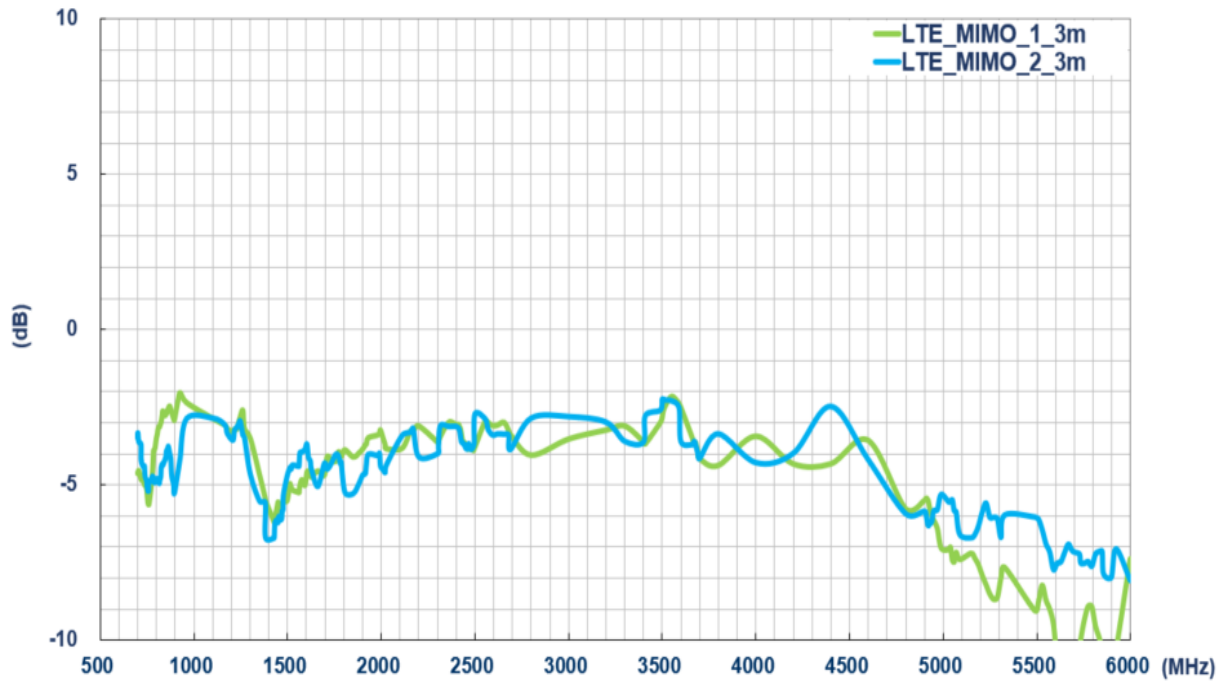

### 3.1.4. Peak Gain – LTE MIMO1 and MIMO2

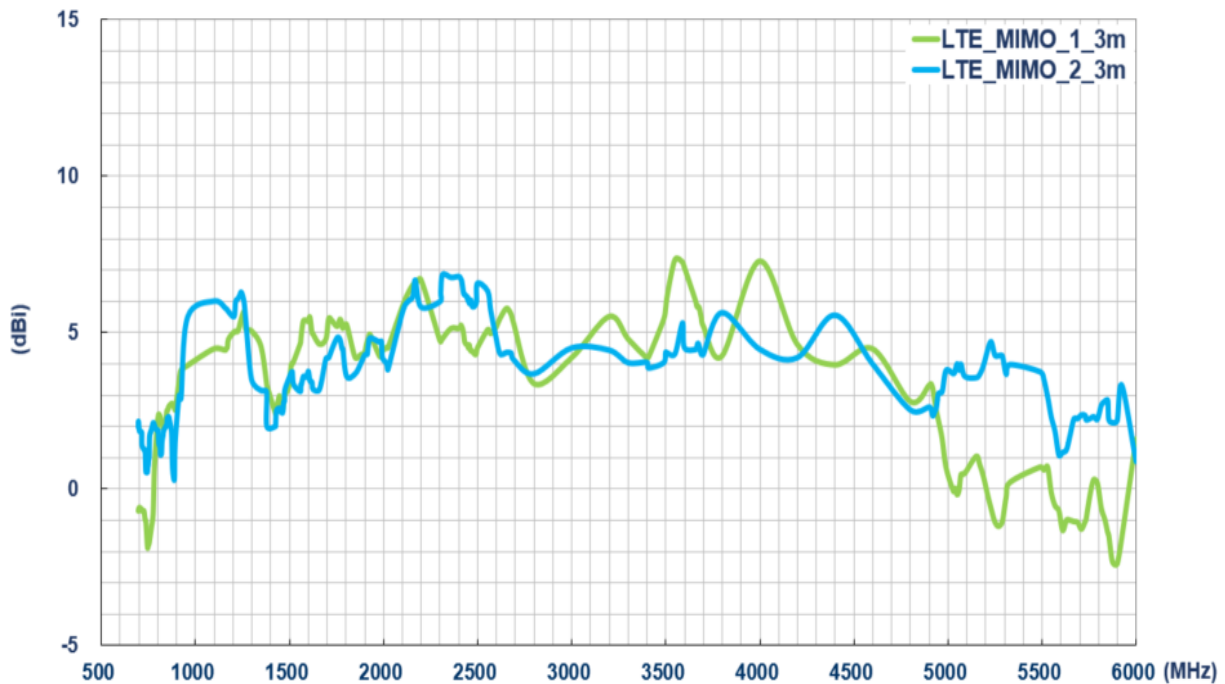

### 3.1.5. Isolation – LTE MIMO1 and MIMO2

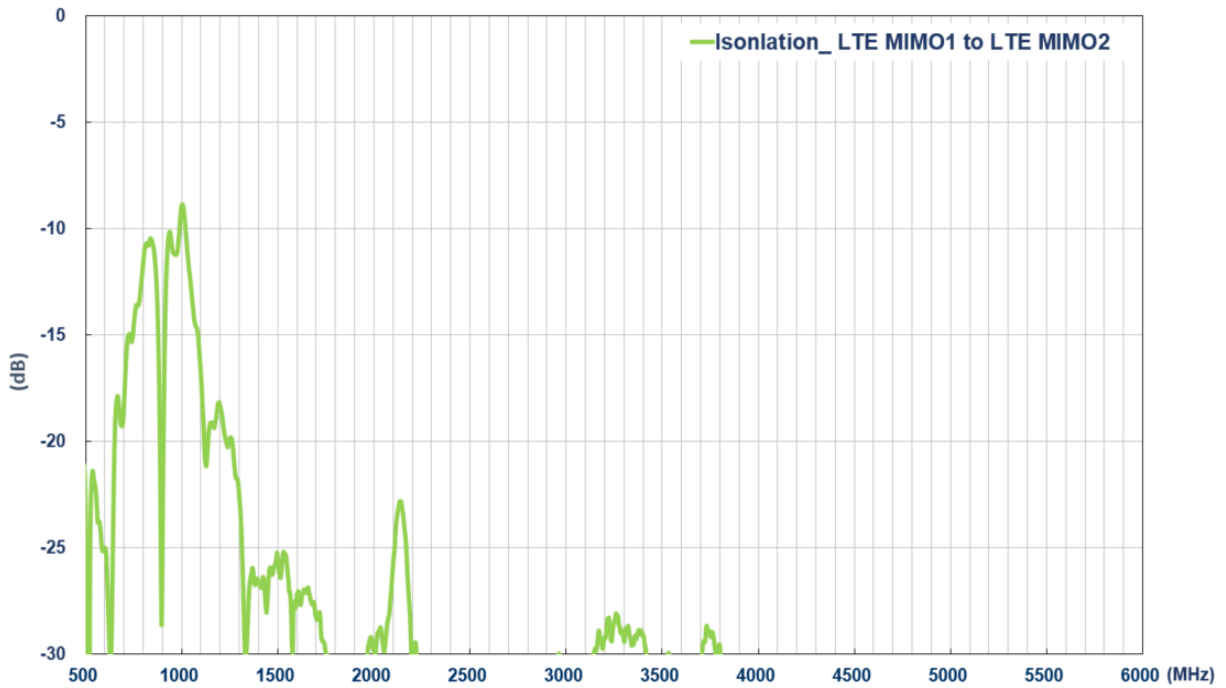

### 3.1.6. ECC – LTE MIMO1 and MIMO2

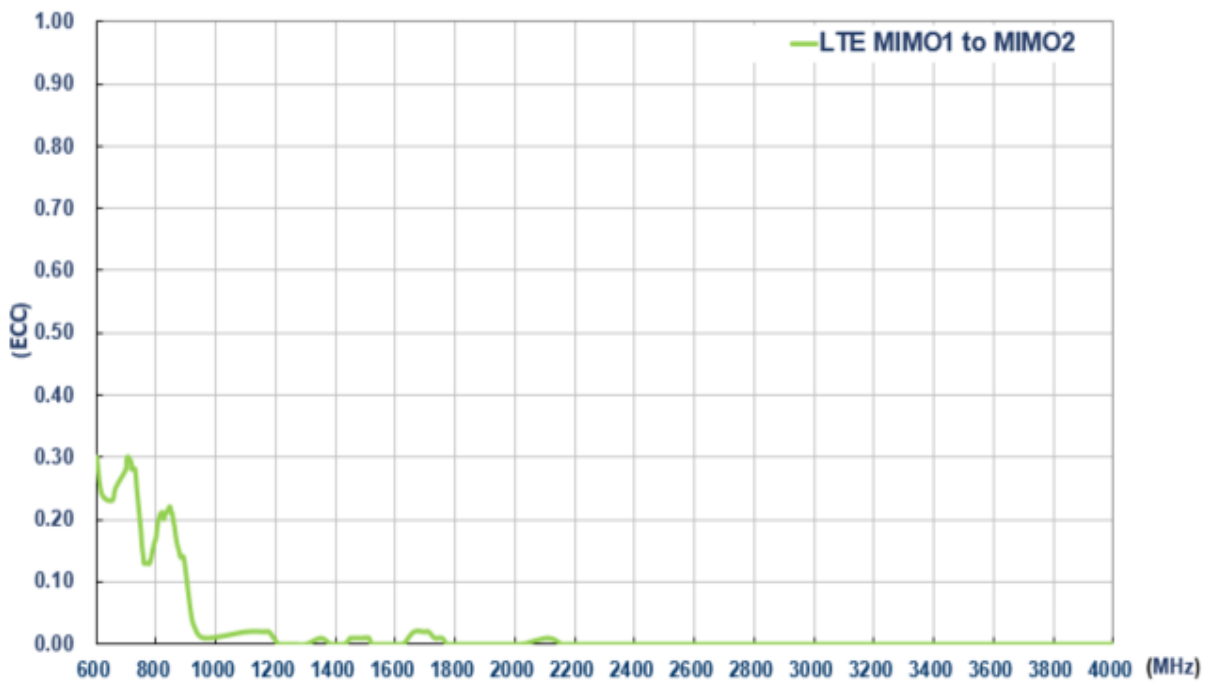

### 3.2. WI-FI MIMO1 and MIMO2 Antennas

#### 3.2.1. Return Loss – WI-FI MIMO1 and MIMO2

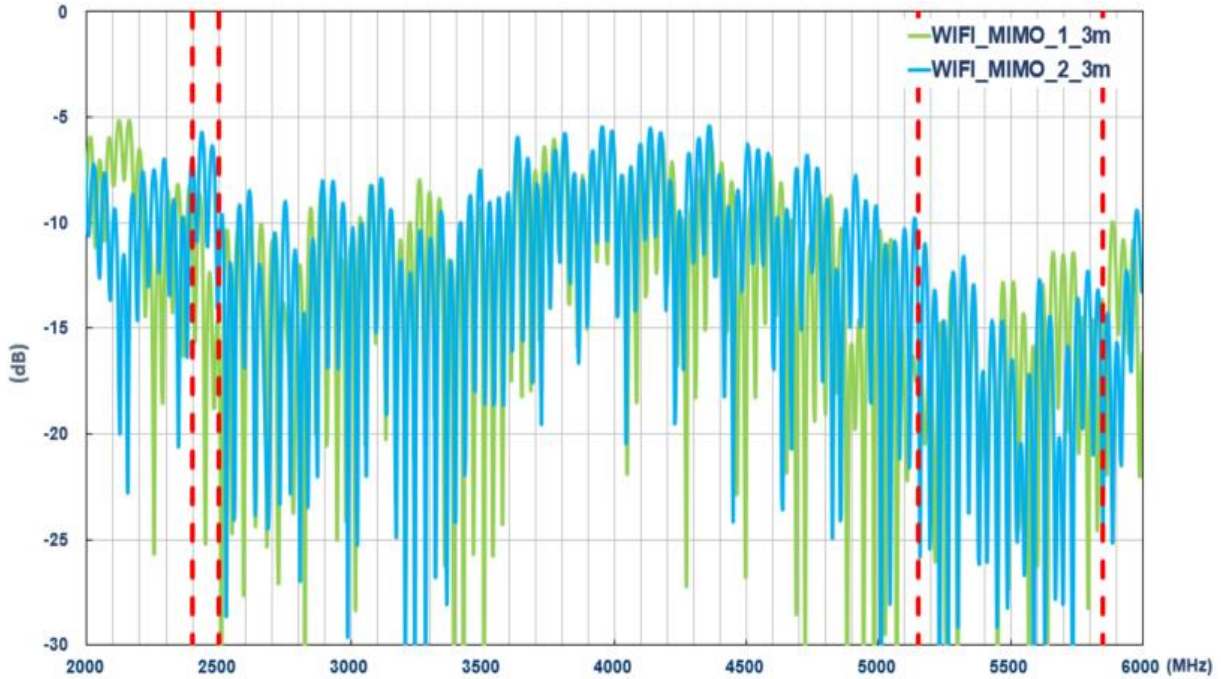

#### 3.2.2. Efficiency – WI-FI MIMO1 and MIMO2

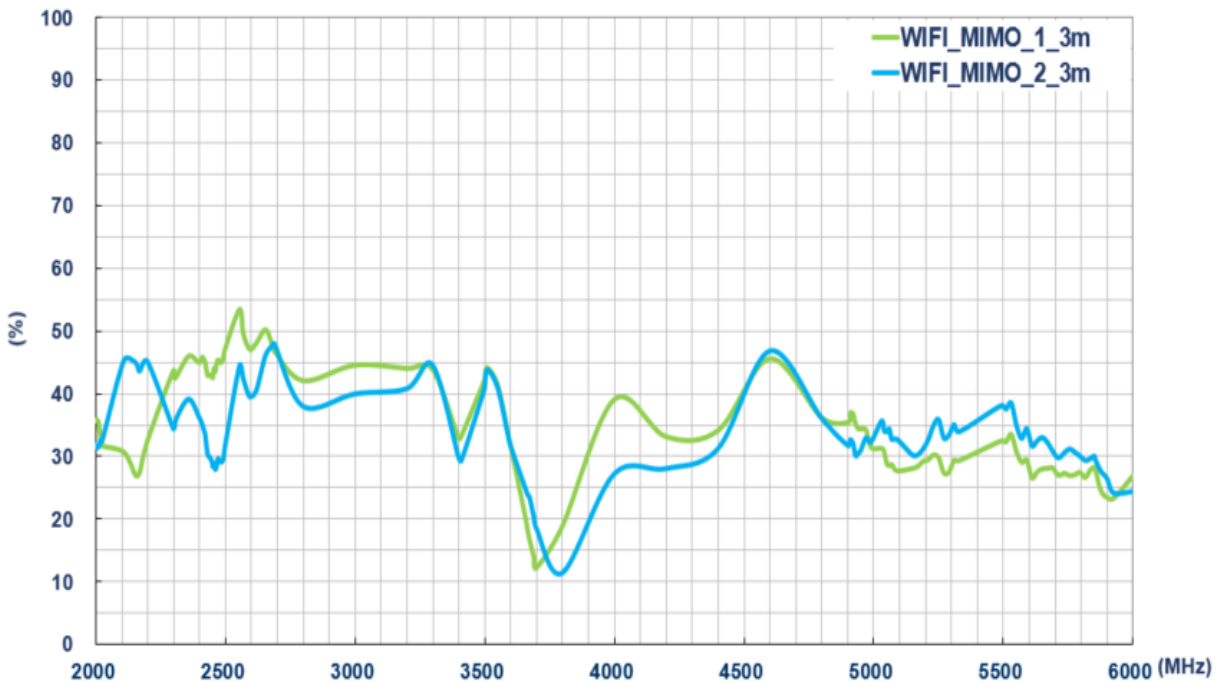

### 3.2.3. Average Gain – WI-FI MIMO1 and MIMO2

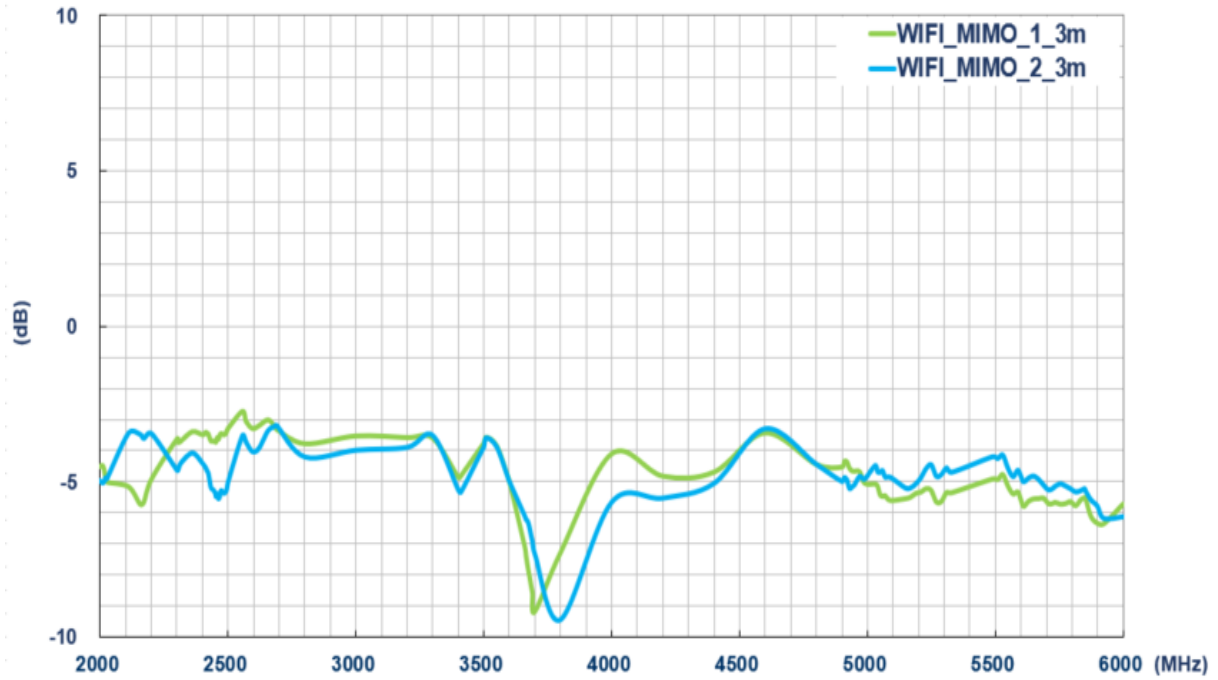

### 3.2.4. Peak Gain – WI-FI MIMO1 and MIMO2

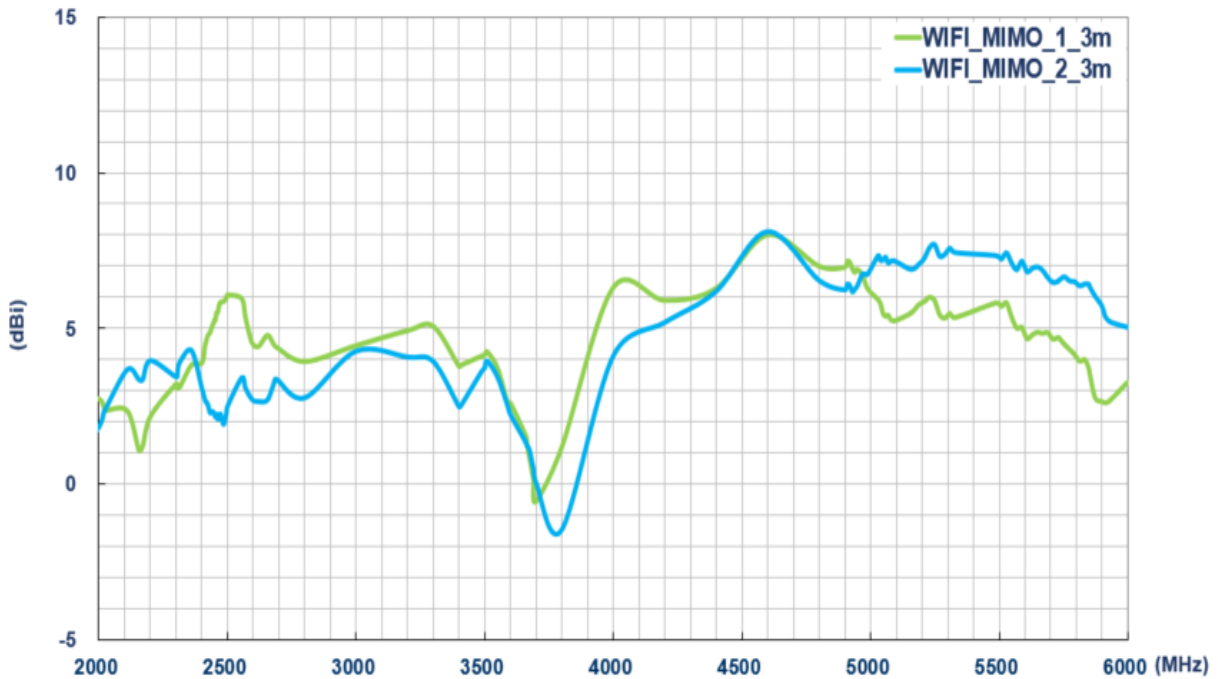

### 3.2.5. Isolation – WI-FI MIMO1 and MIMO2

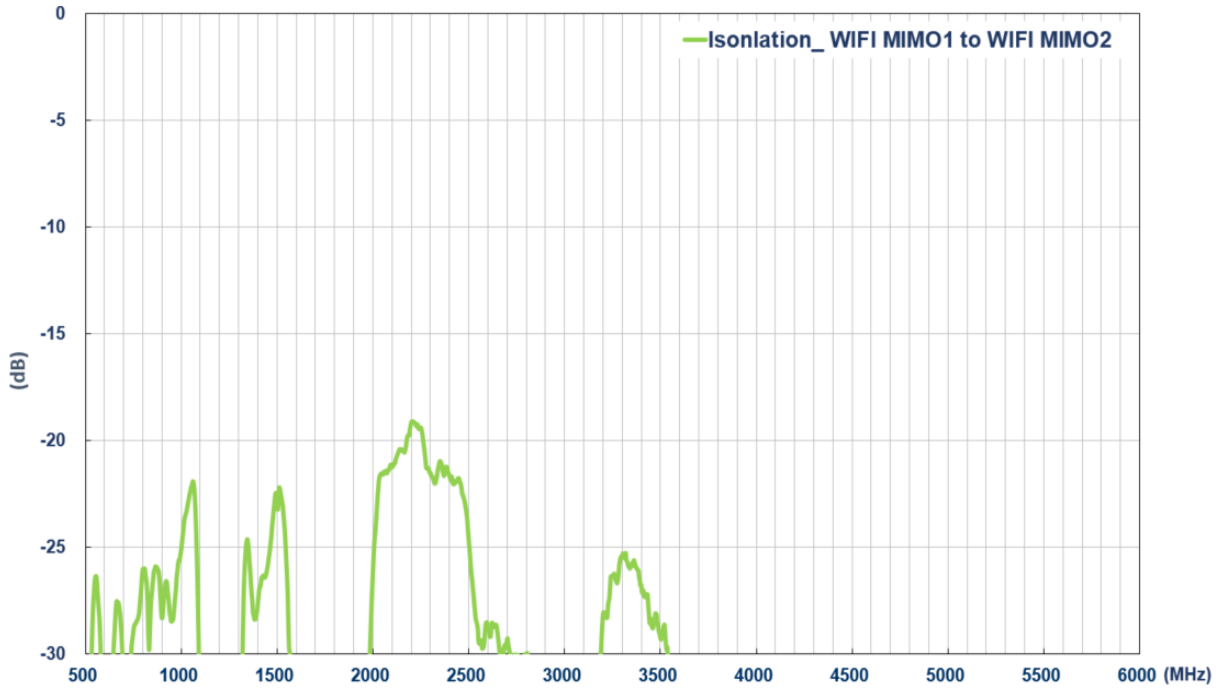

### 3.2.6. ECC – WI-FI MIMO1 and MIMO2

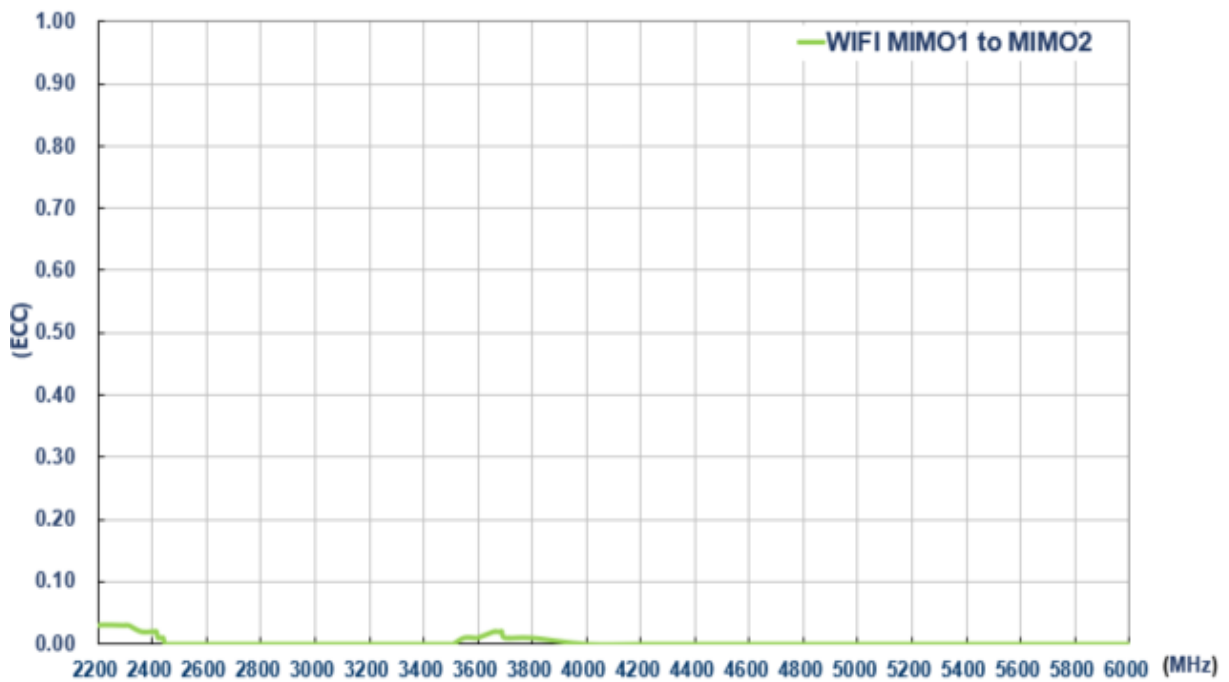

### 3.3. GNSS Antenna

#### 3.3.1. Block Diagram (Active antenna)

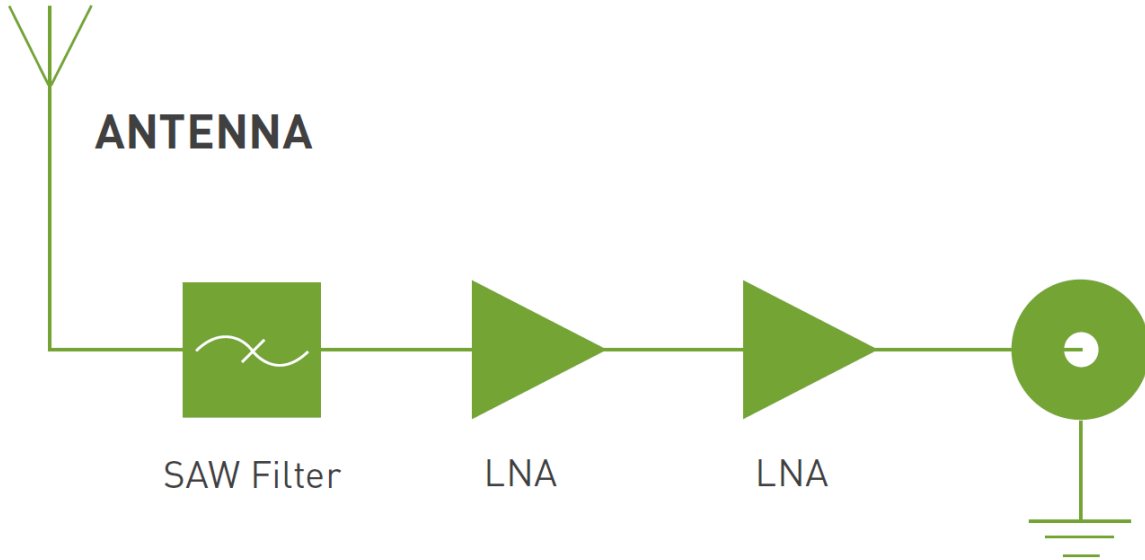

#### 3.3.2. Return Loss – GNSS Antenna

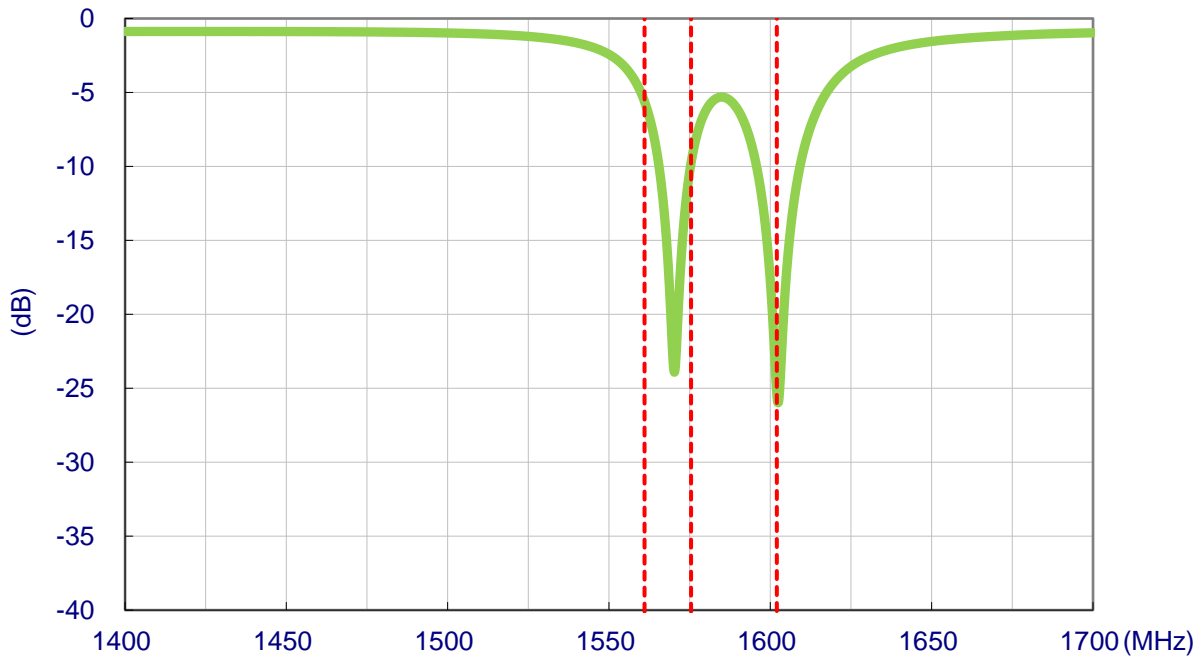

### 3.3.3. Efficiency – GNSS Antenna (passive measurement)

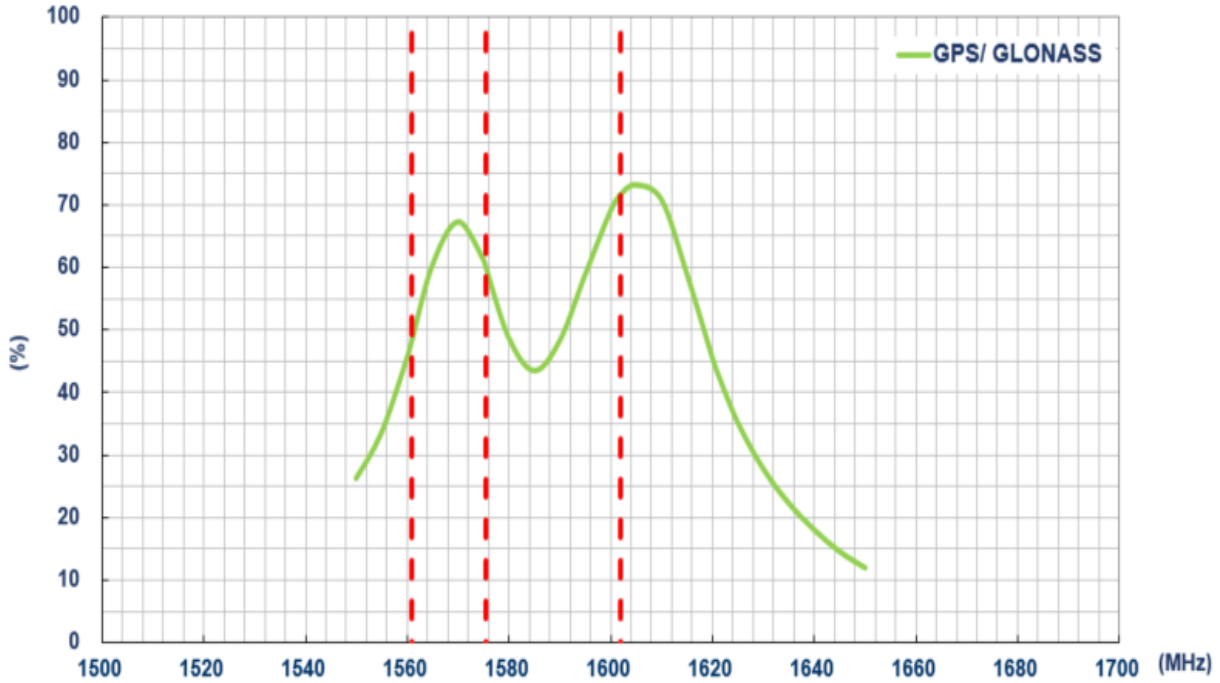

### 3.3.4. Average Gain – GNSS Antenna (passive measurement)

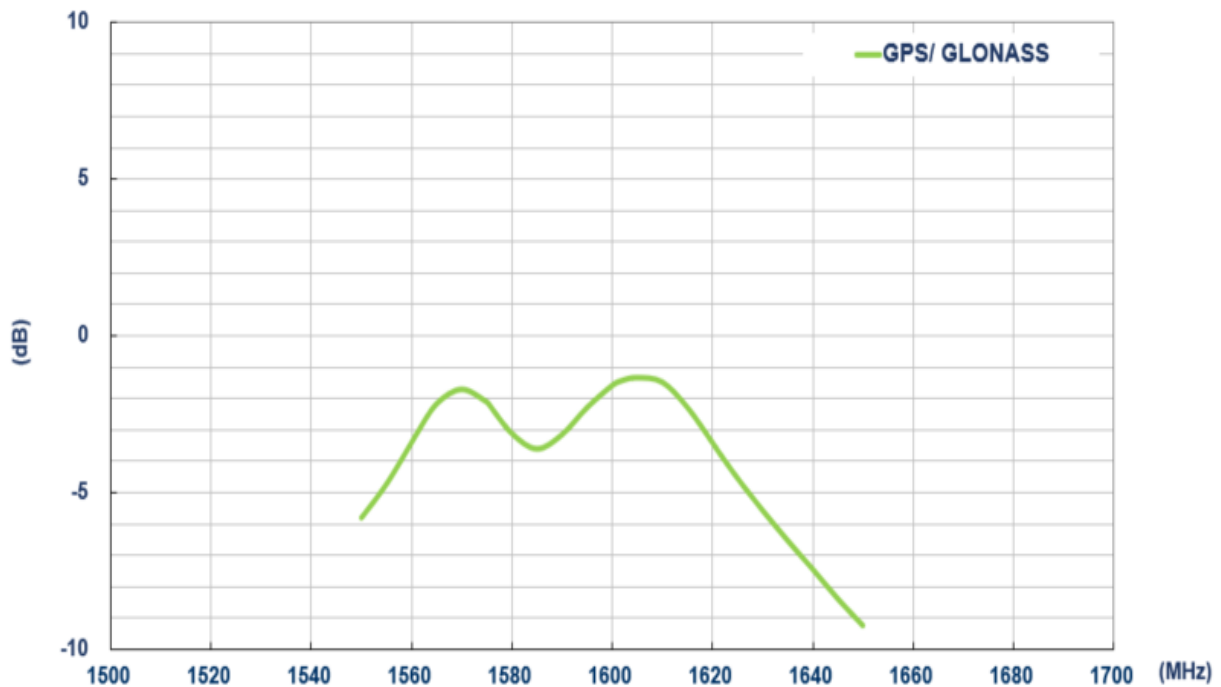



### 3.3.5. Peak Gain – GNSS Antenna (passive measurement)

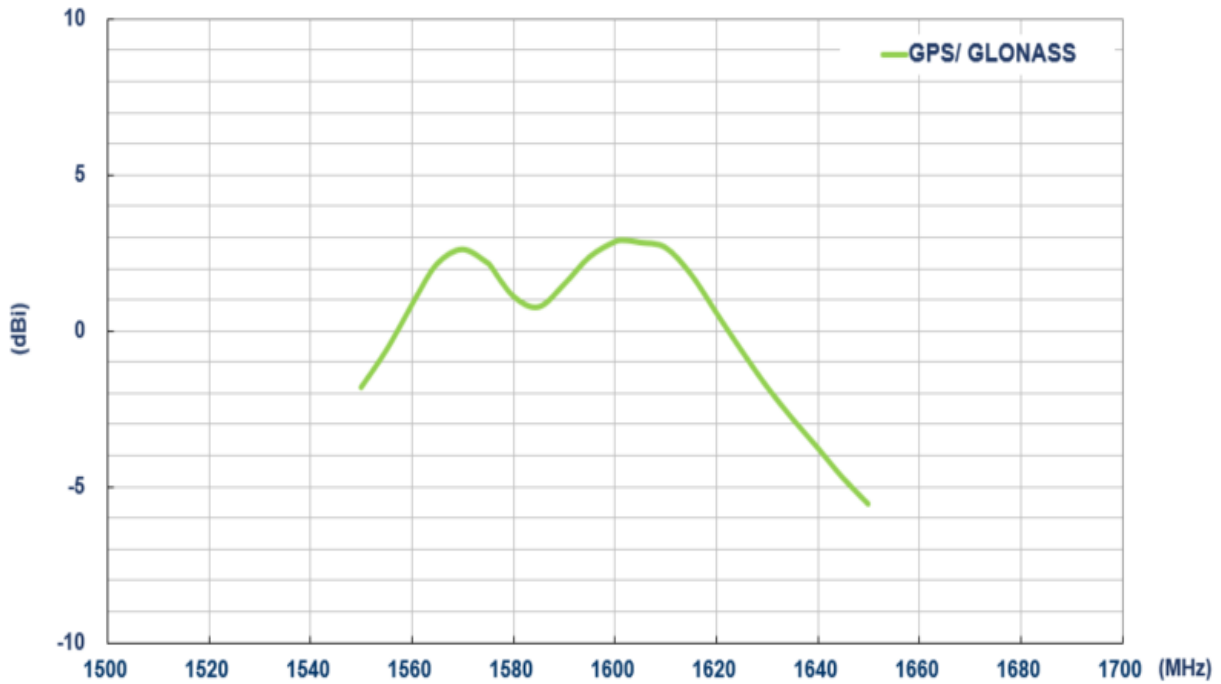

### 3.3.6. Axial Ratio – GNSS Antenna (Zenith is at 0° )

#### Axial Ratio at GPS L1 (1575.42 MHz)

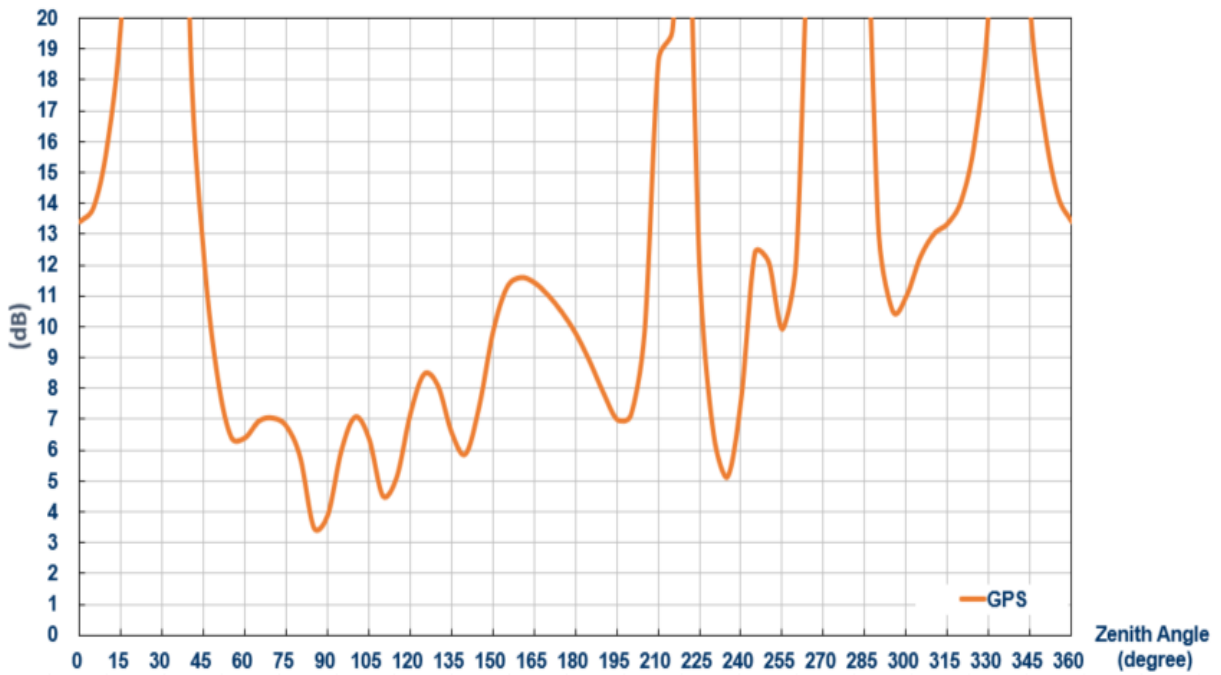

**Axial Ratio at GLONASS L1 (1602 MHz)**

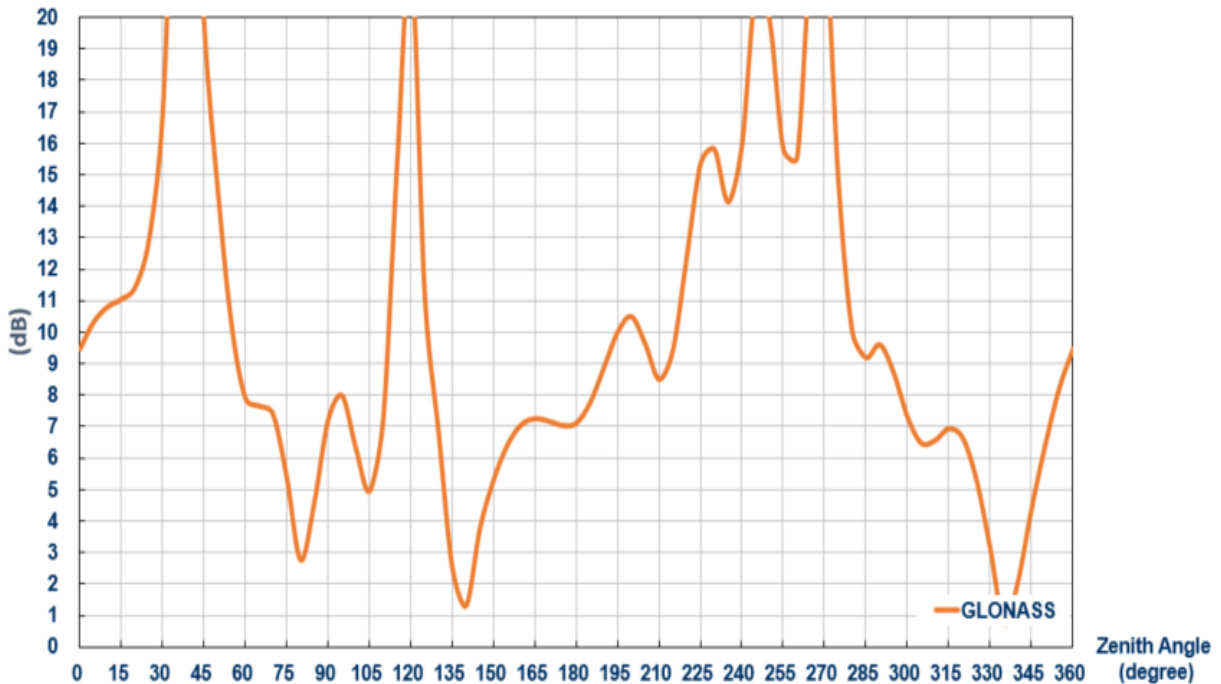

### 3.3.7. GNSS Antenna Active Measurements

#### LNA Gain @ 3.0V

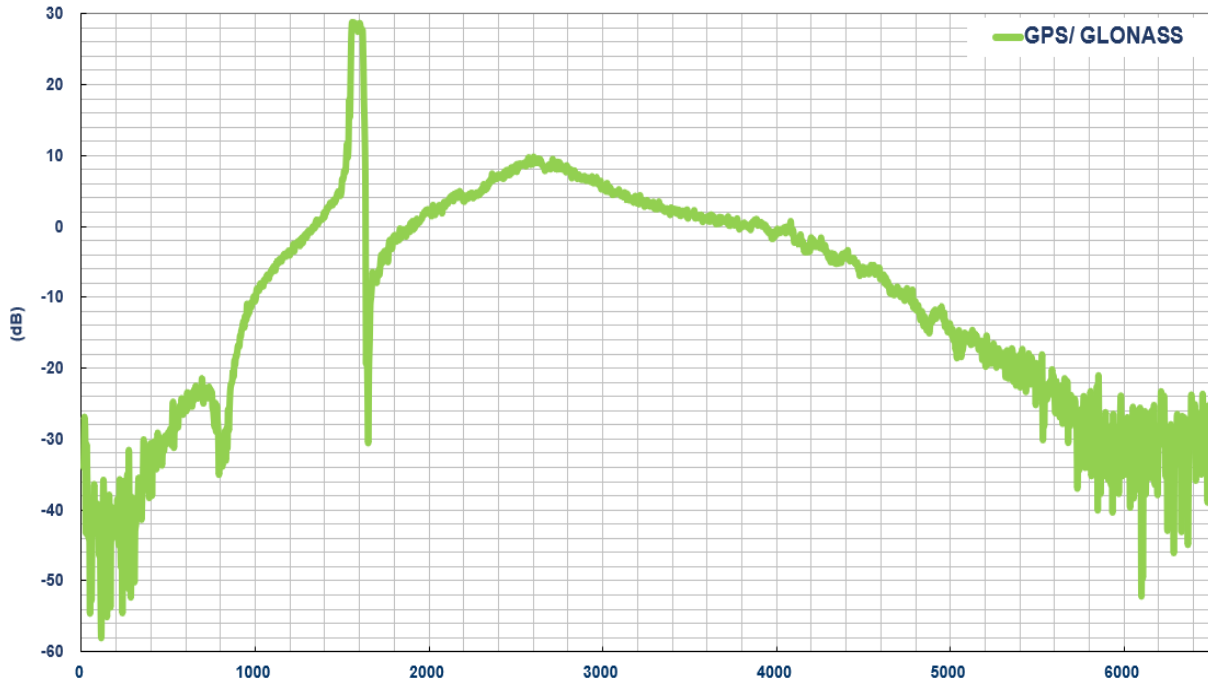

#### LNA Gain and Noise Figure @ 3.0V

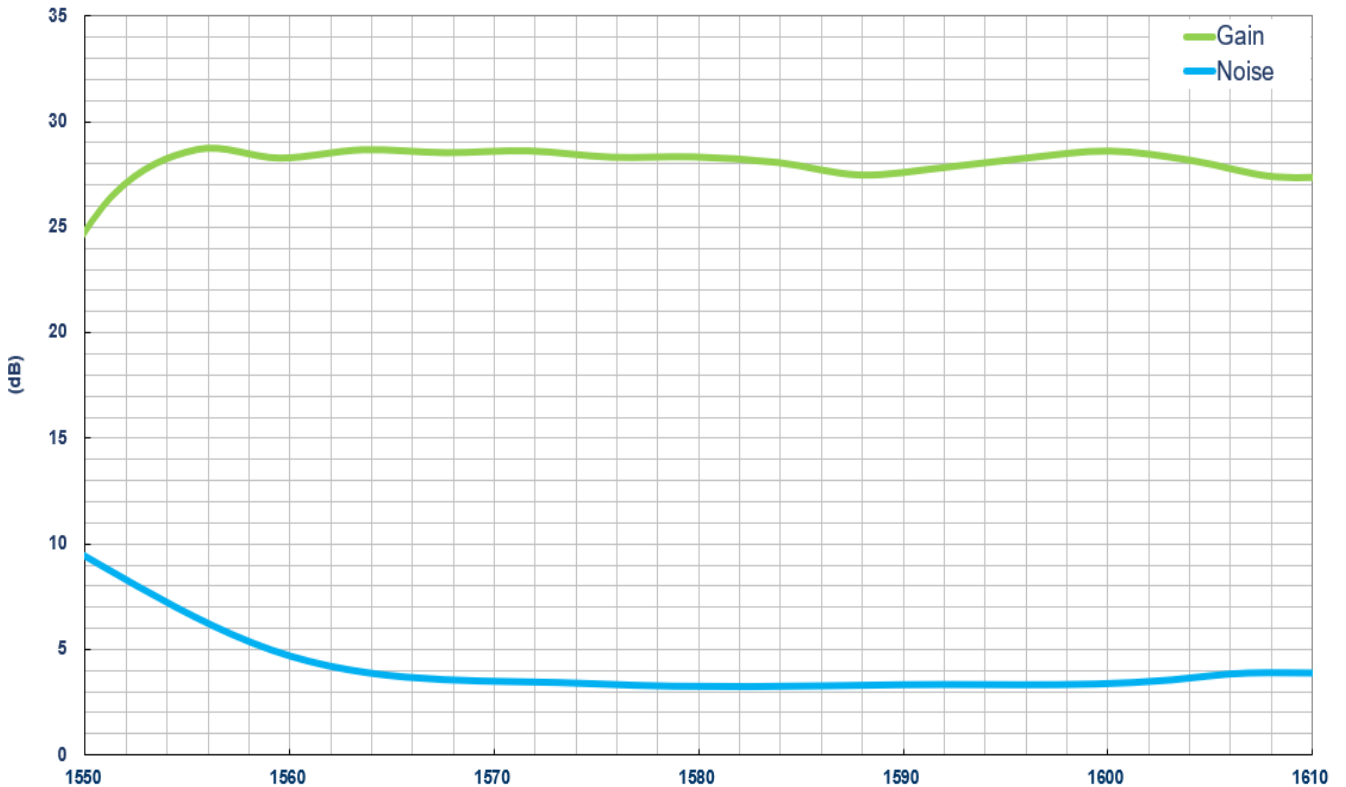

## 4. Antenna Radiation Patterns

### 4.1 Antenna Setup

On 30\*30cm GND

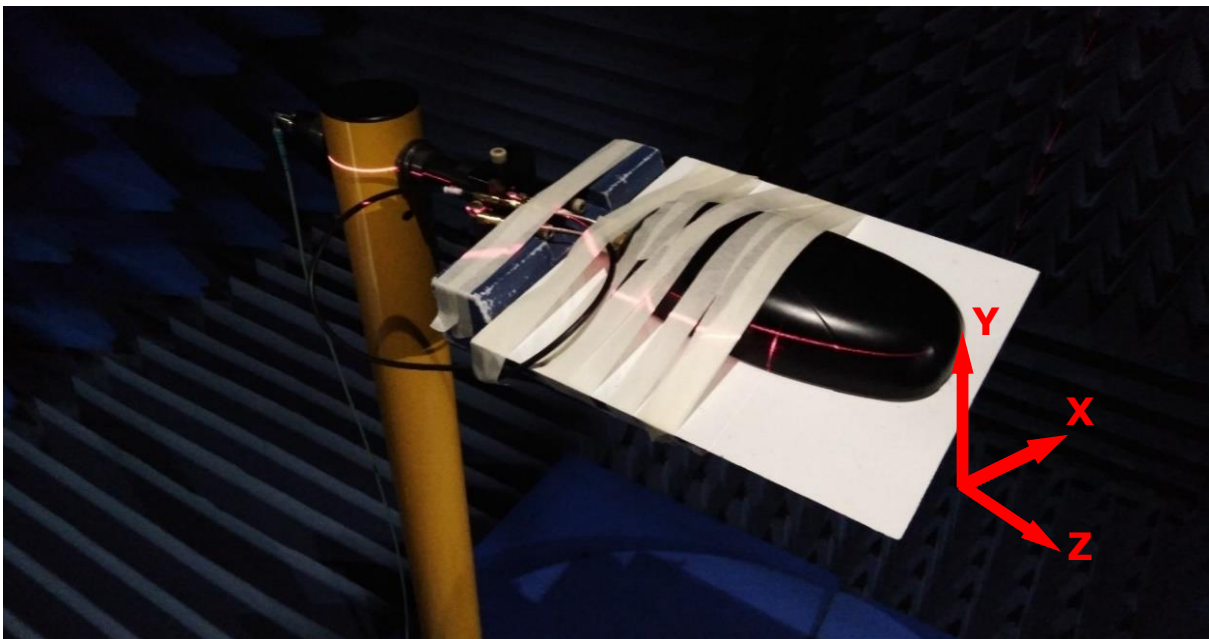



## 4.2 2D Radiation Patterns

### 4.2.1 LTE MIMO1\_On 30x30cm GND

#### XY Plane

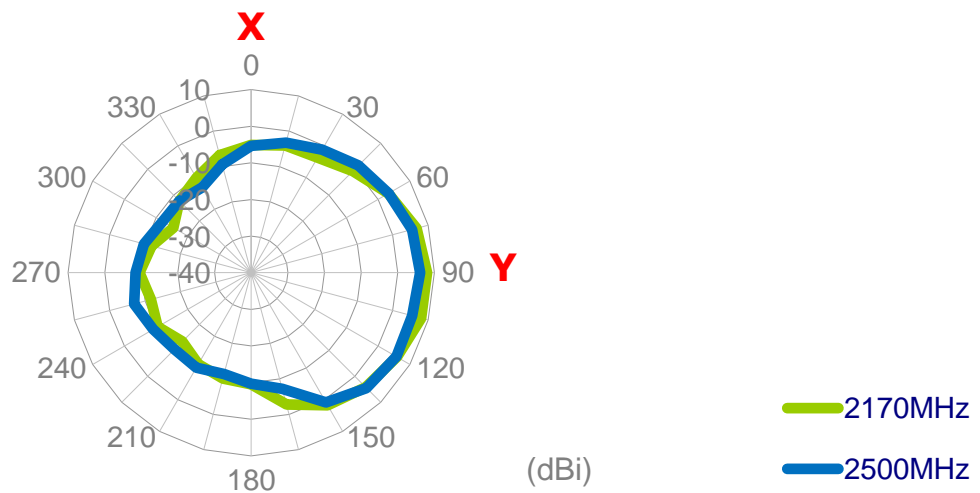
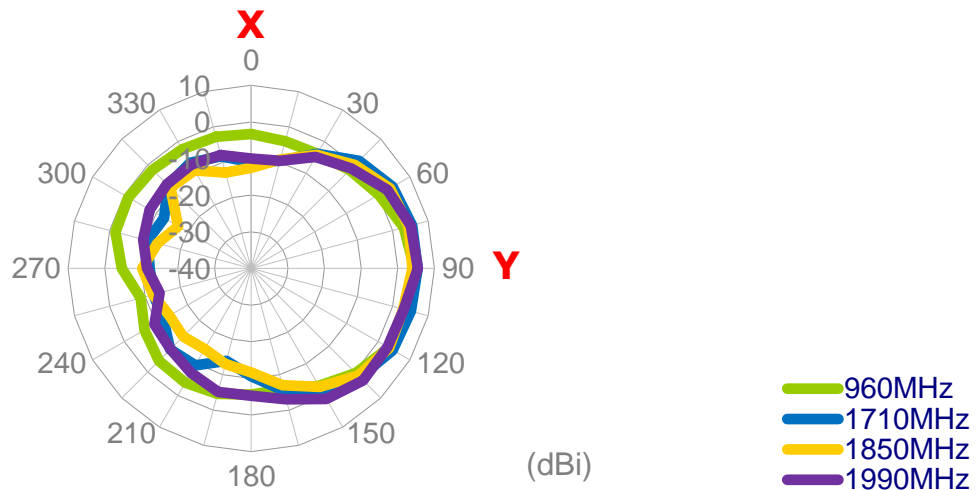
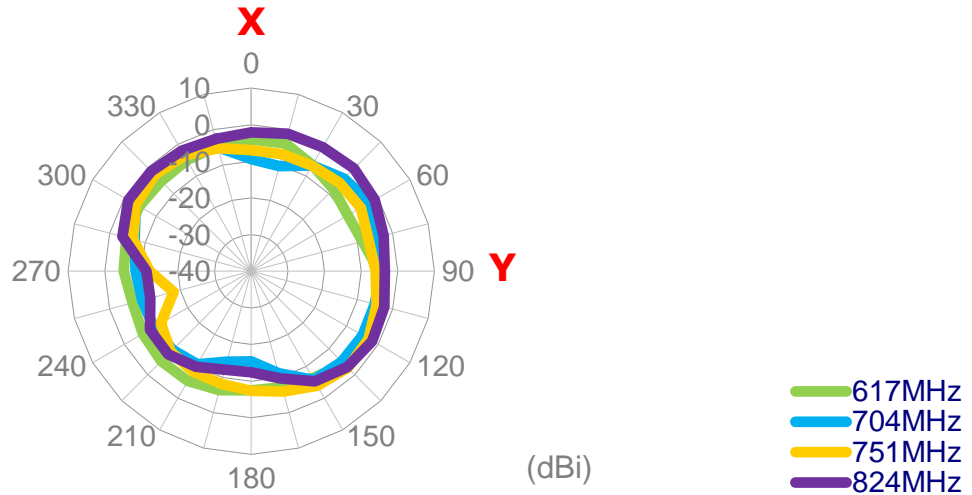

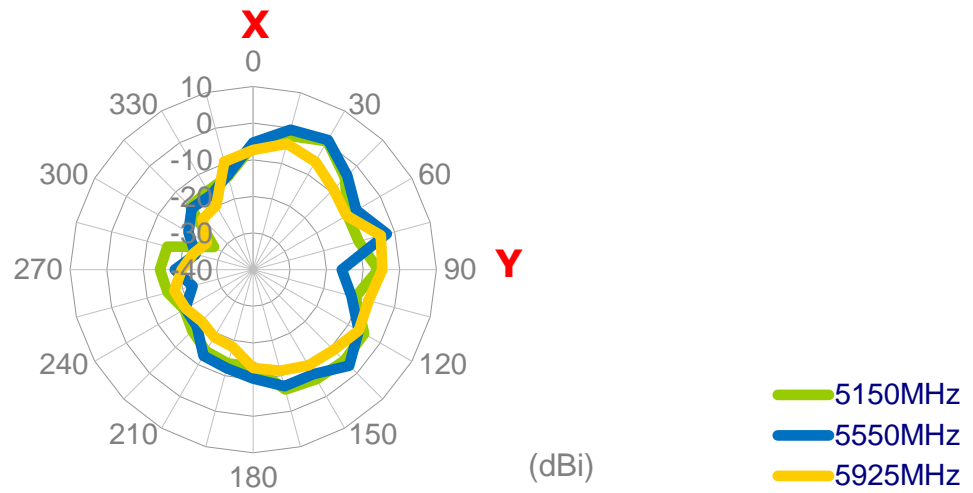
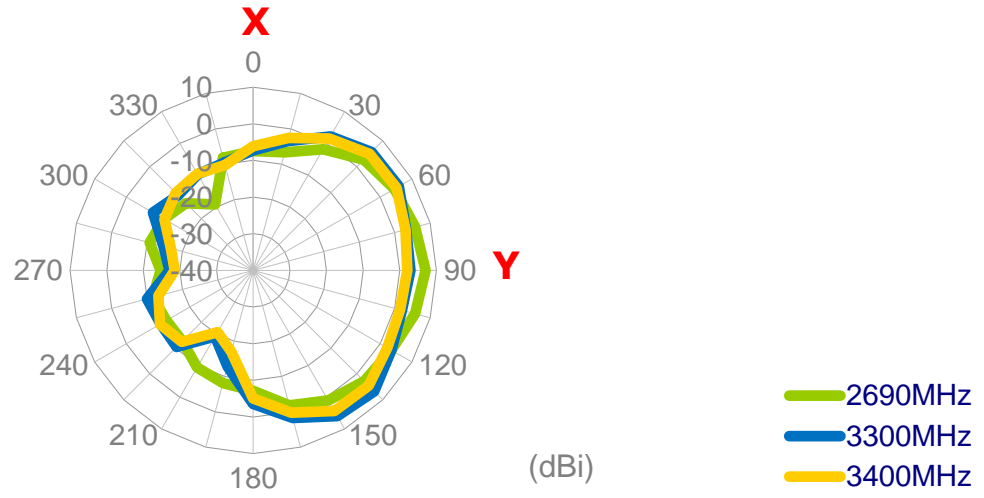

**XZ Plane**

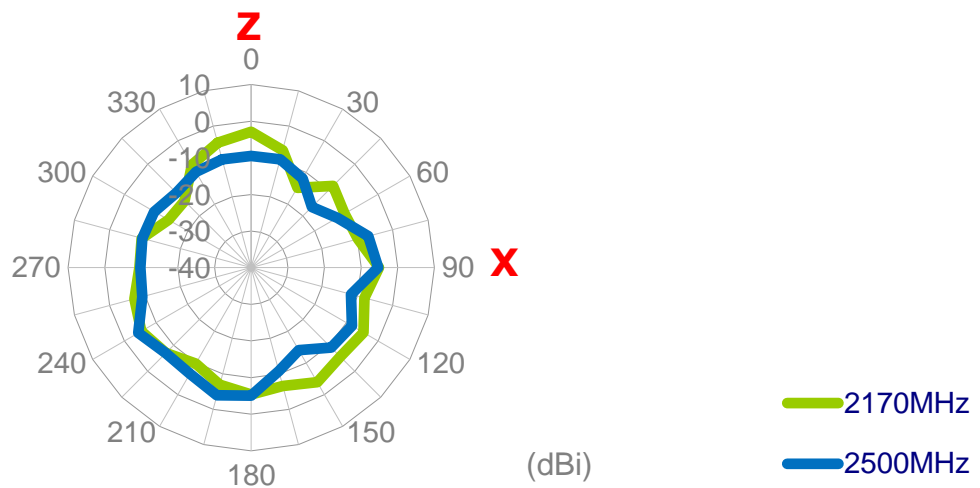
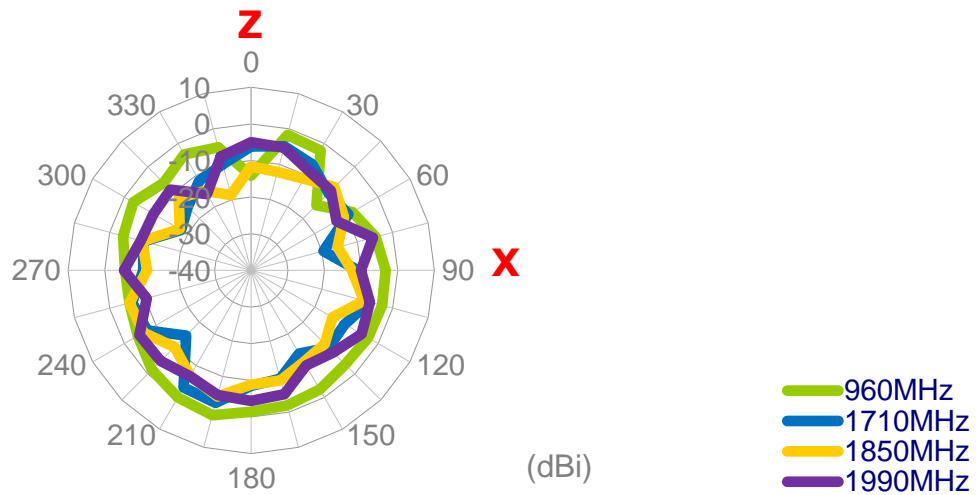
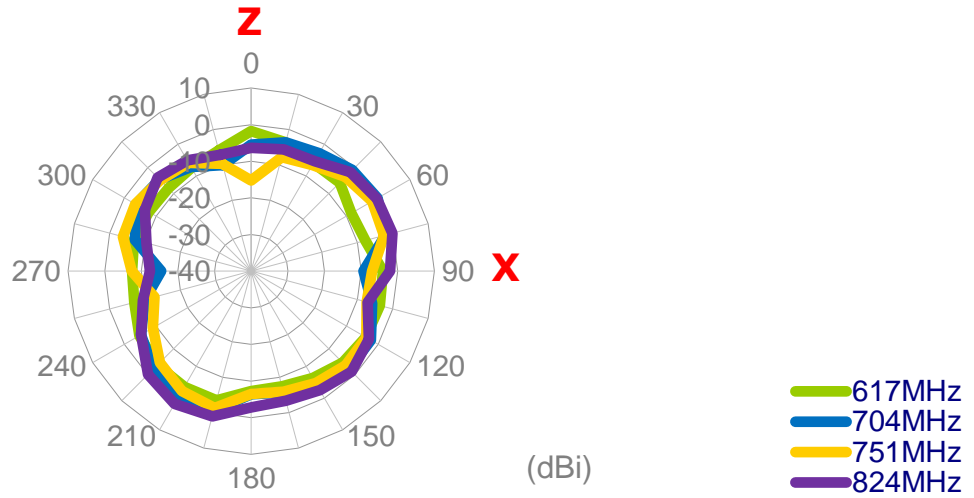



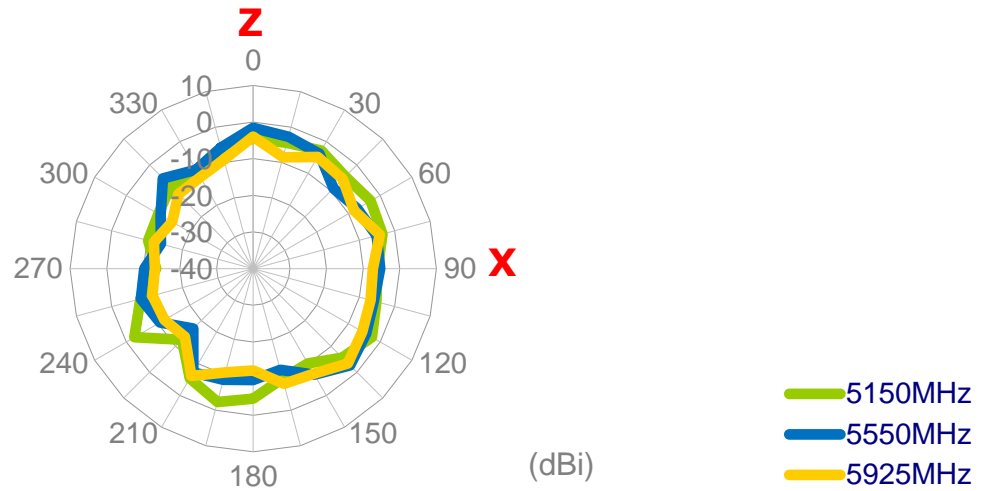
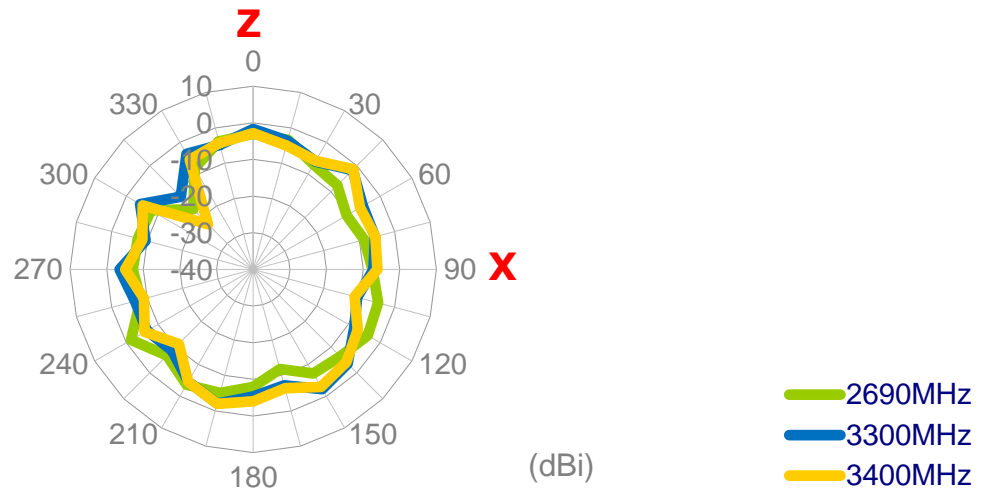

**YZ Plane**

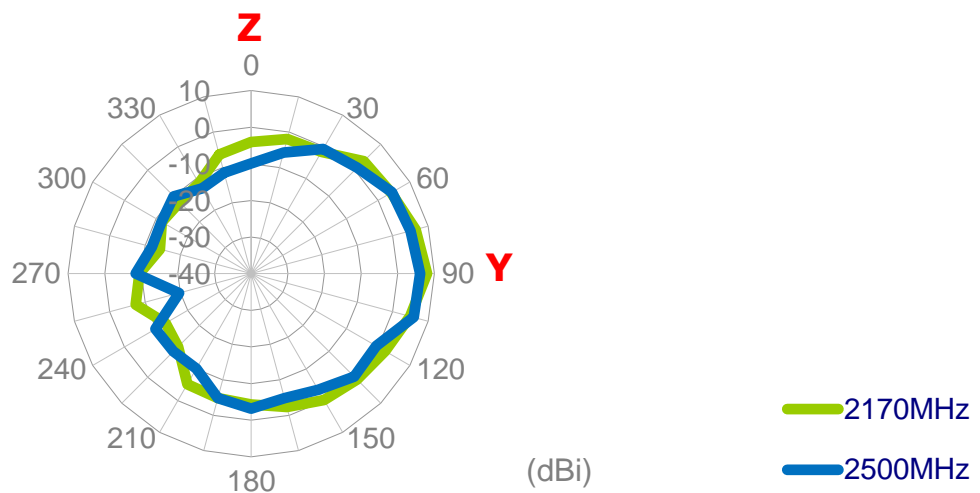
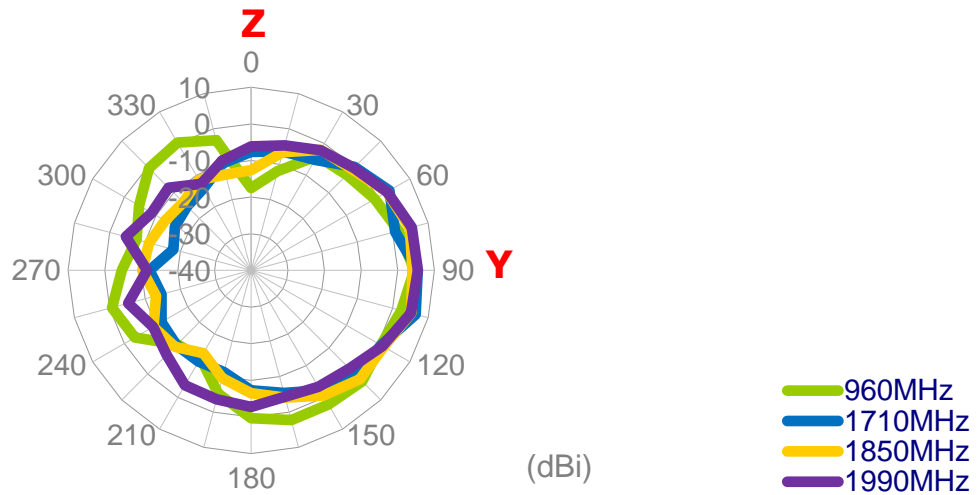
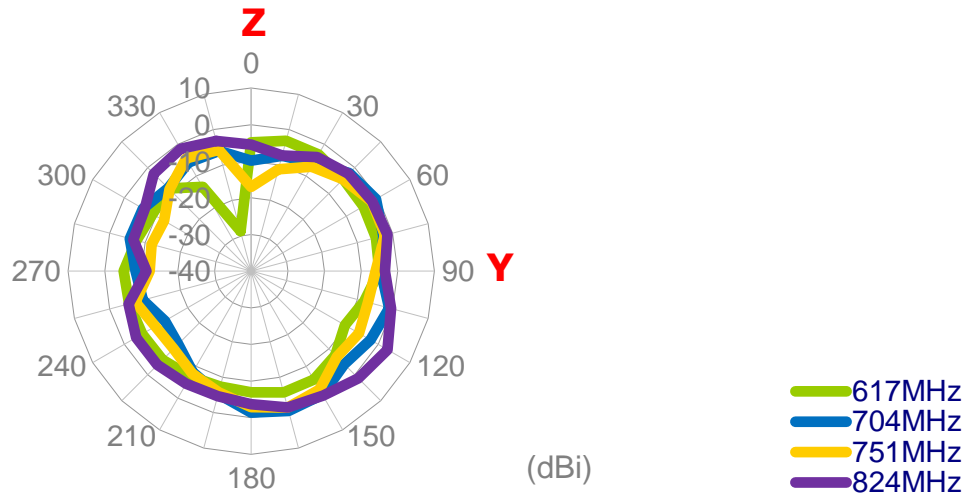

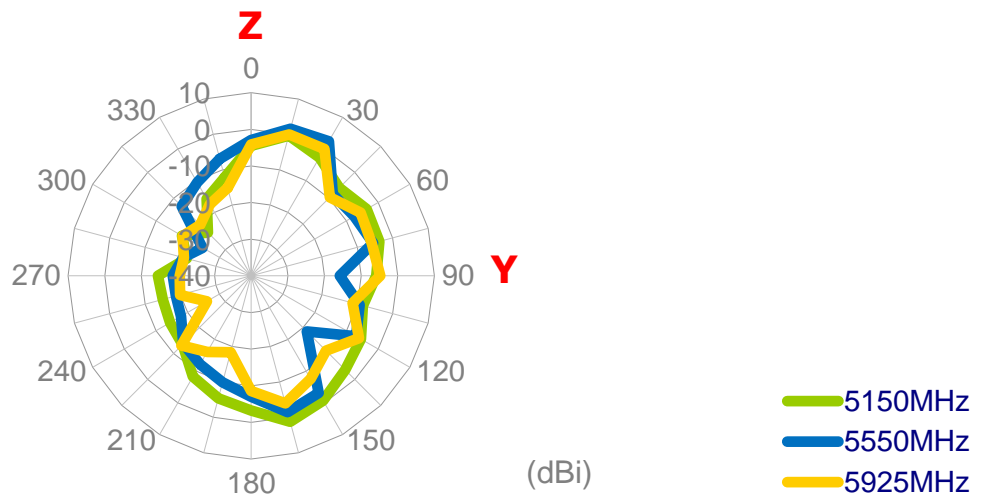
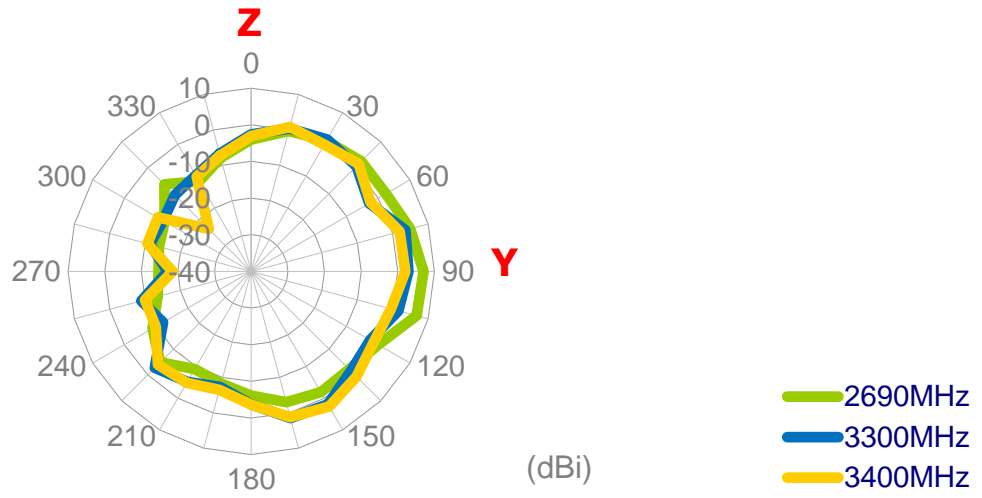

**4.2.2 LTE MIMO2\_On 30x30cm GND**

**XY Plane**

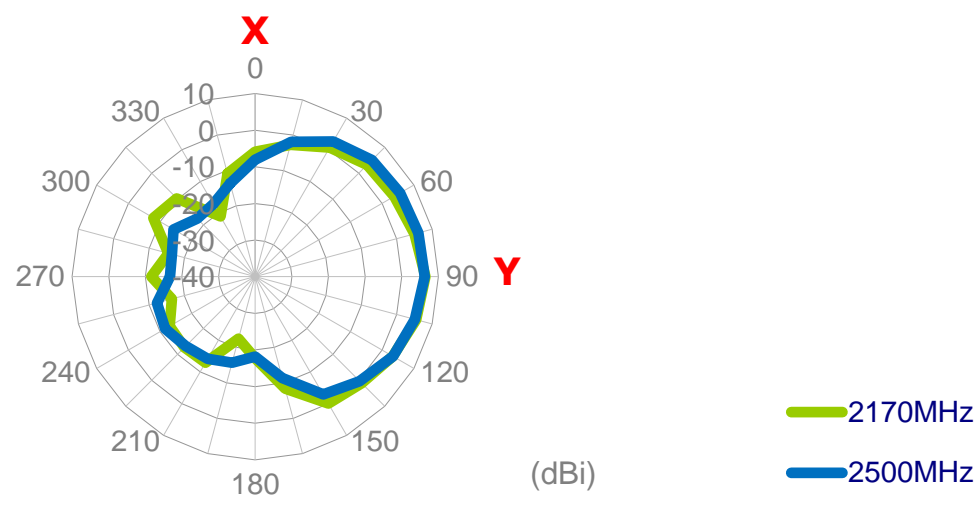
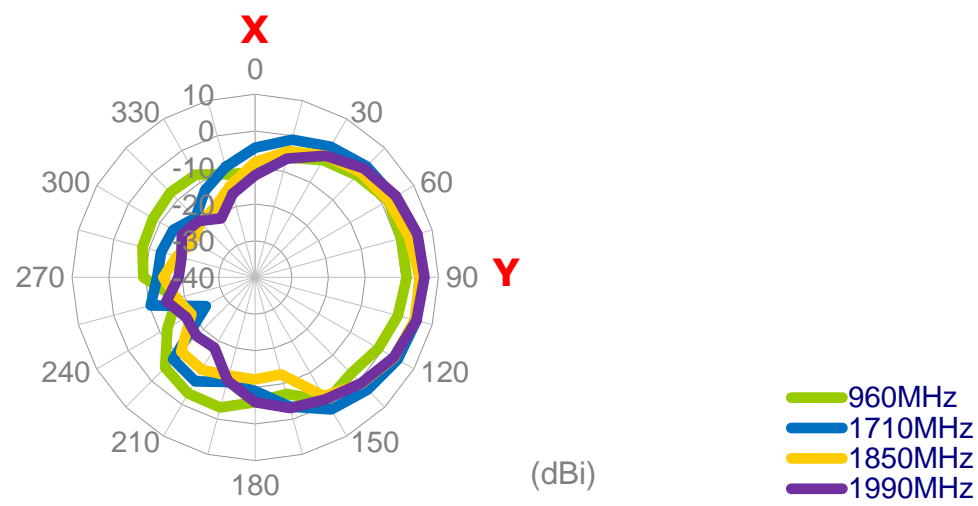
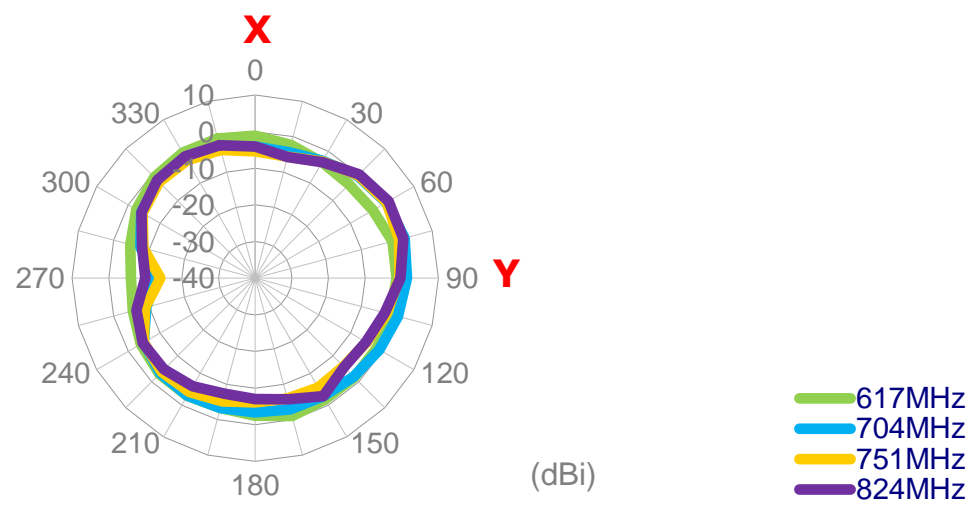

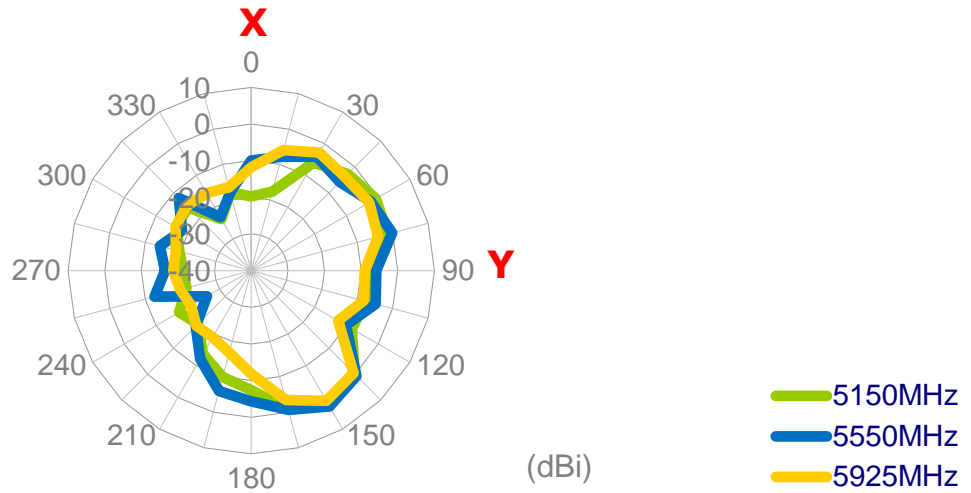
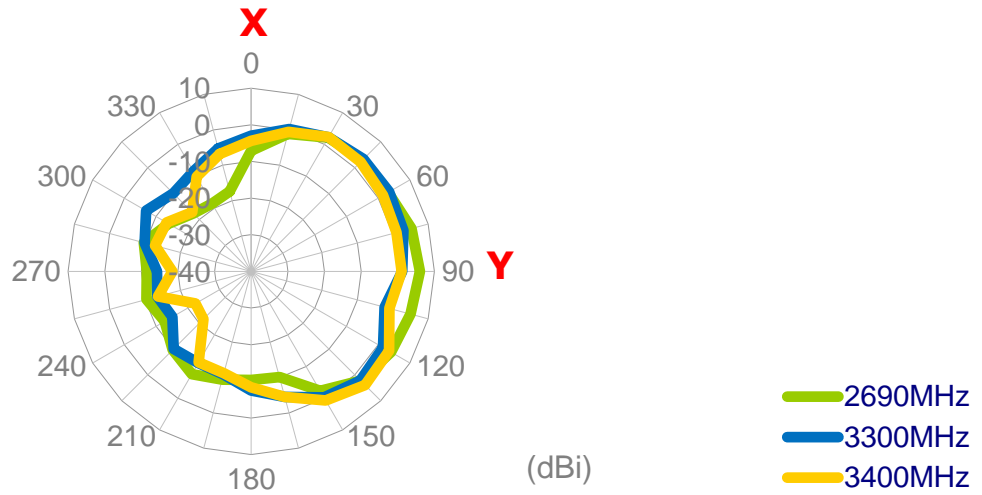

**XZ Plane**

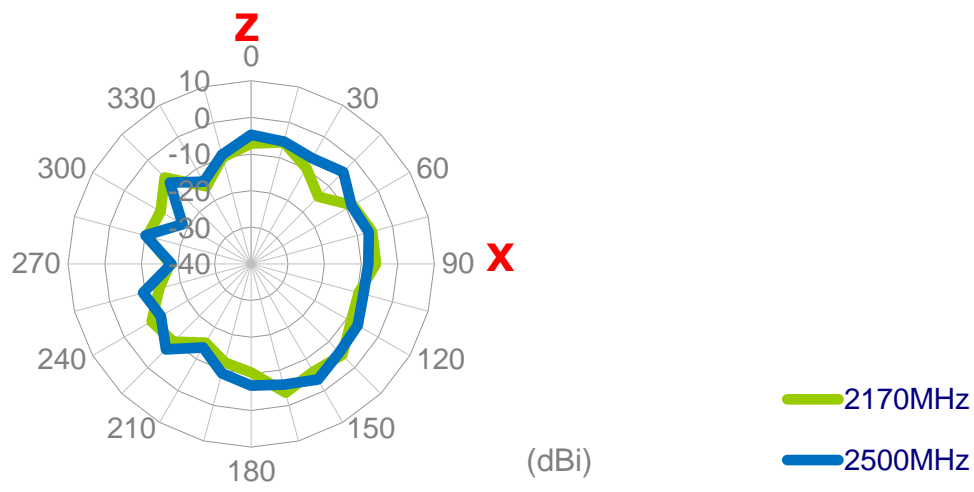
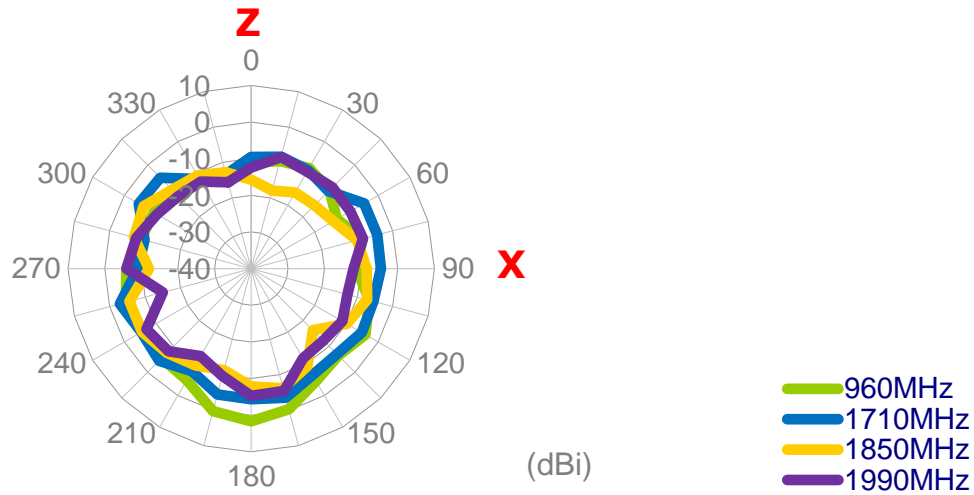
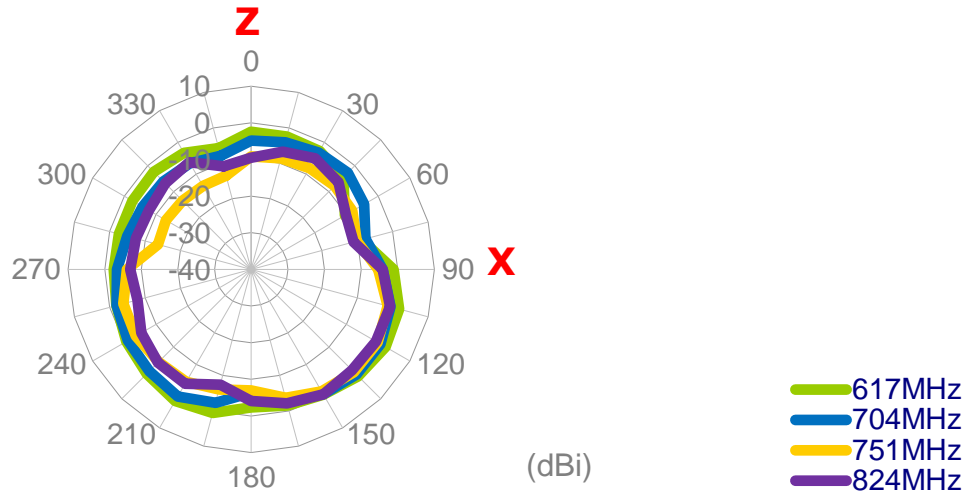

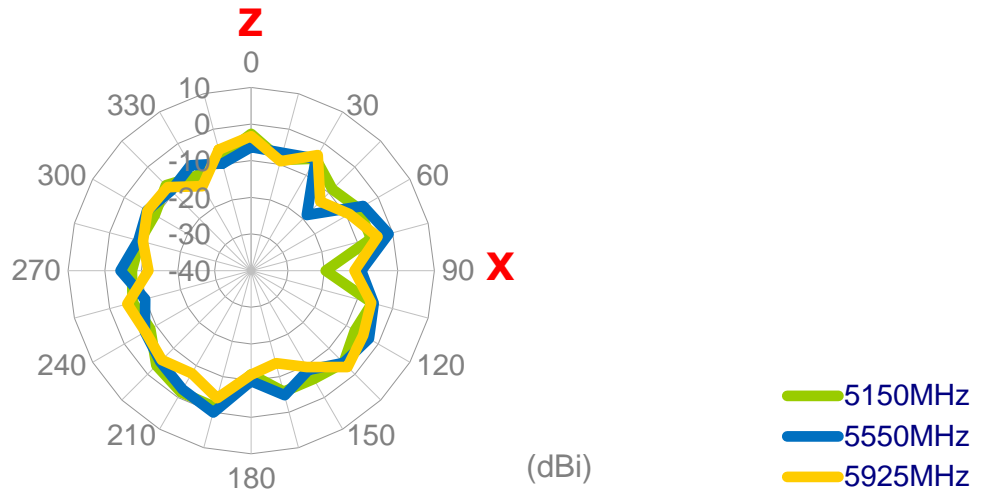
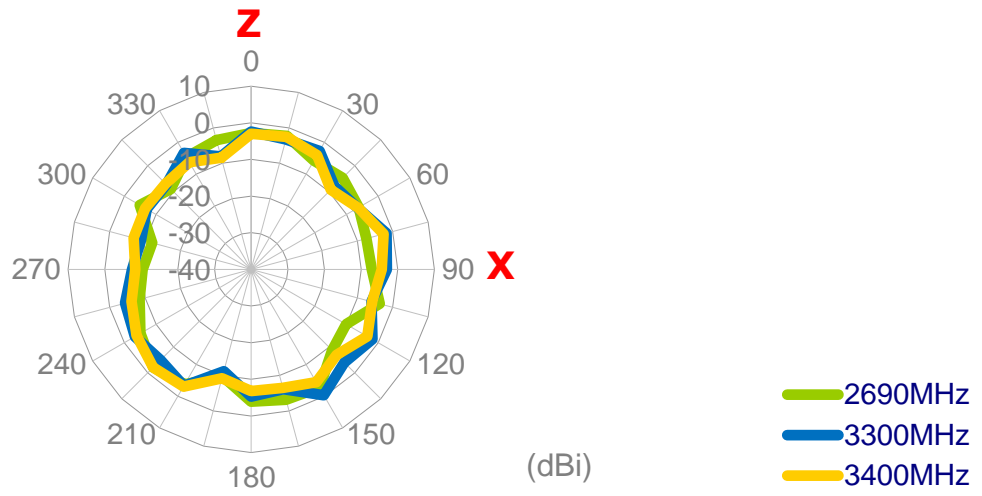

**YZ Plane**

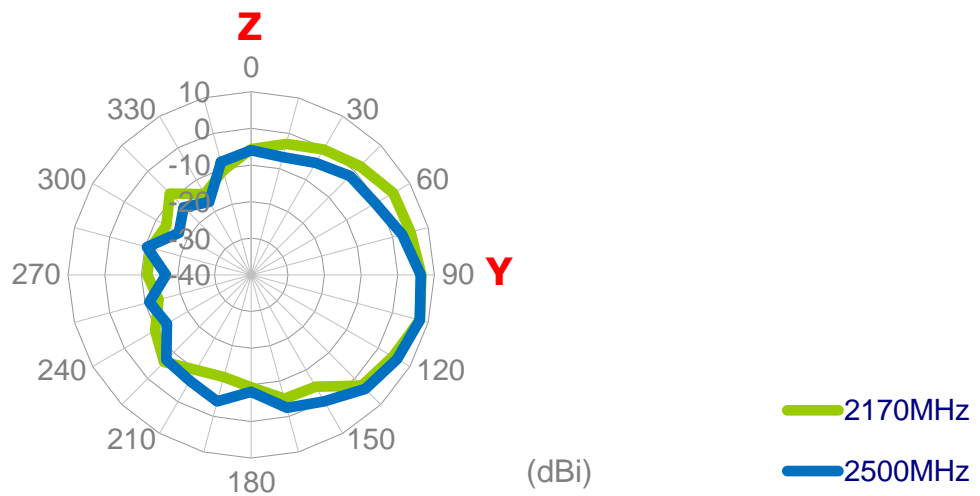
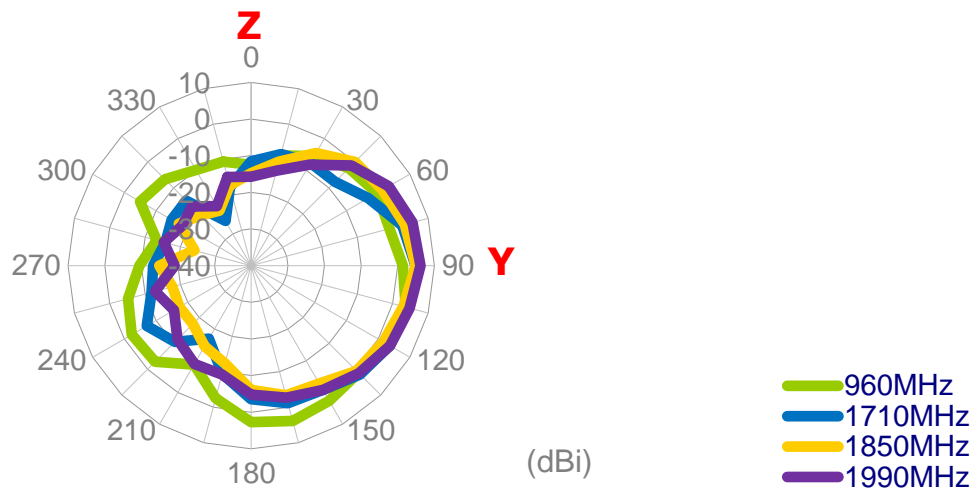
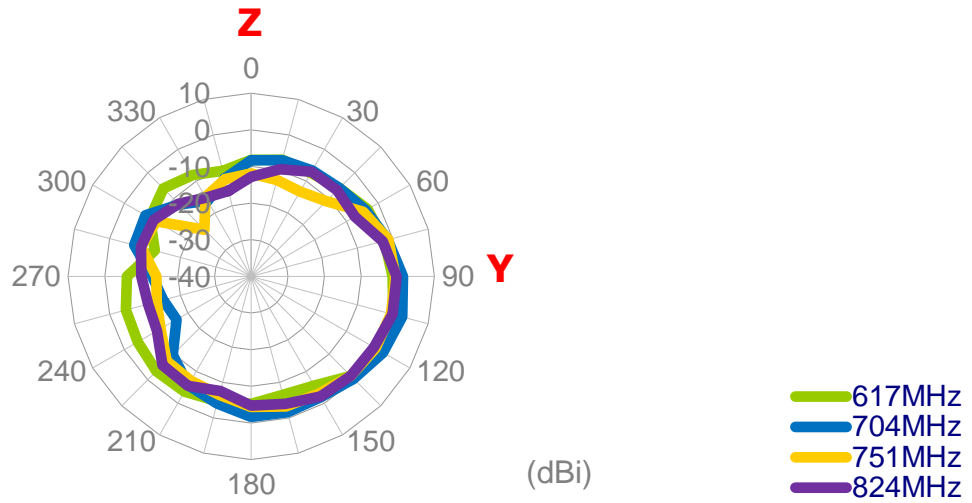



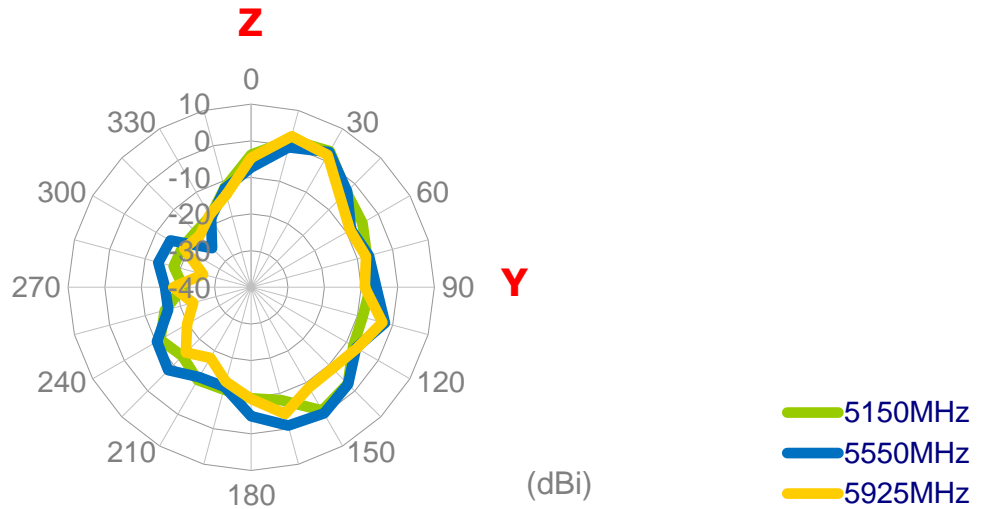
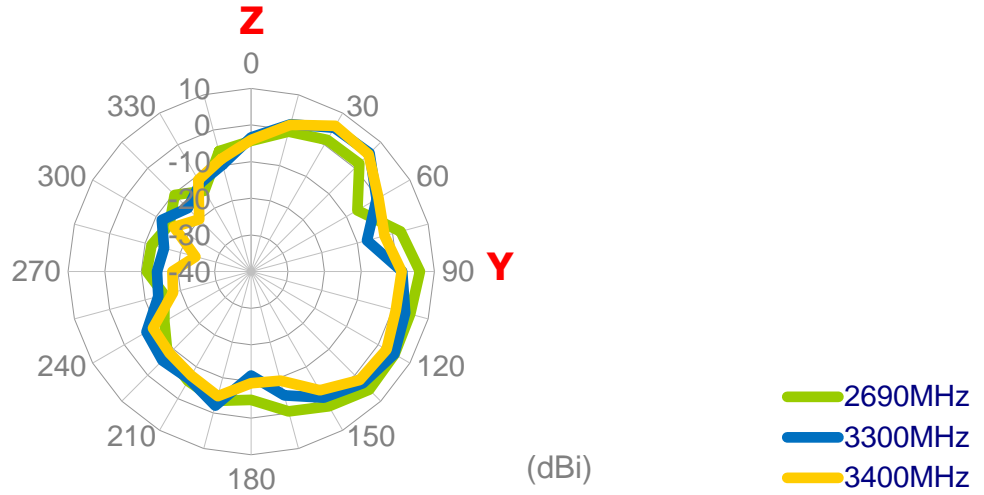

### 4.2.3 WI-FI MIMO1\_On 30x30cm GND

#### XY Plane

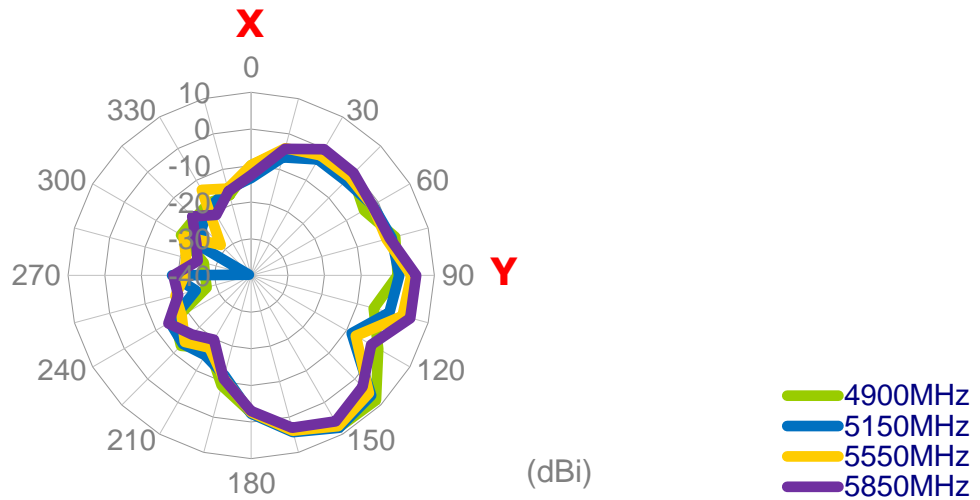
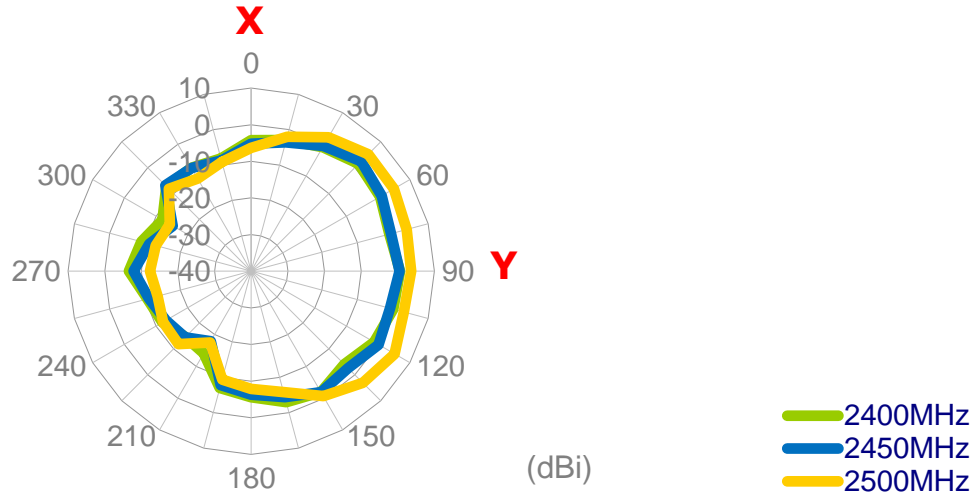

**XZ Plane**

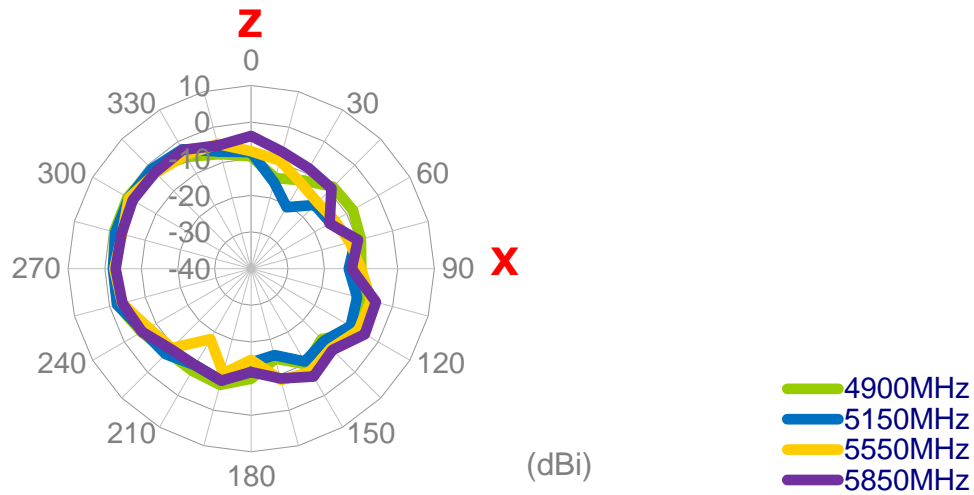
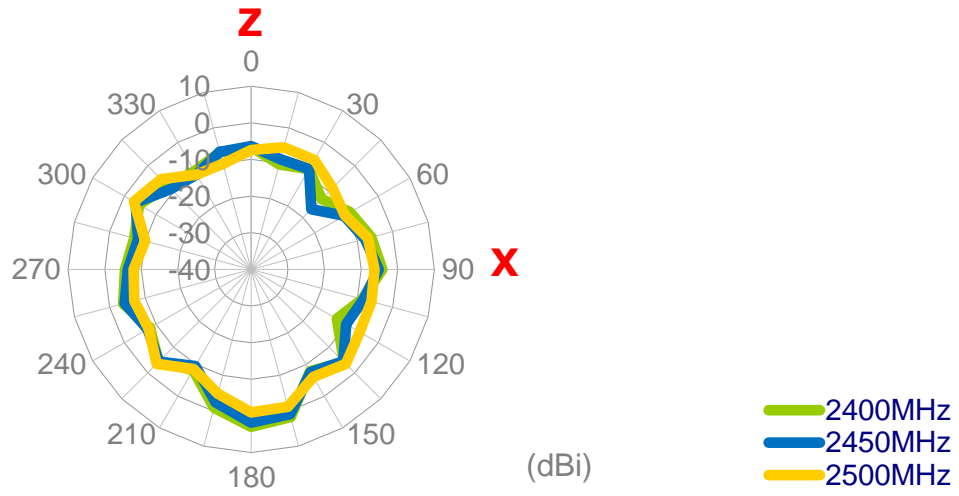

**YZ Plane**

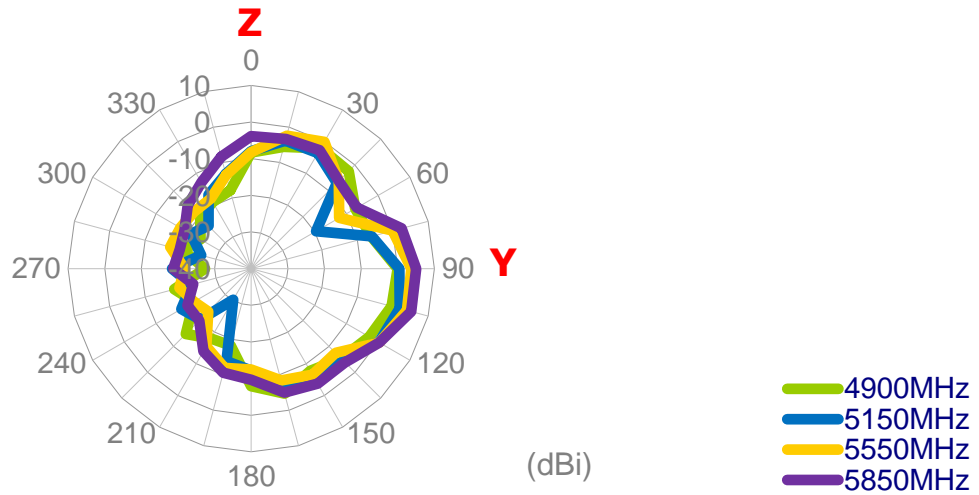
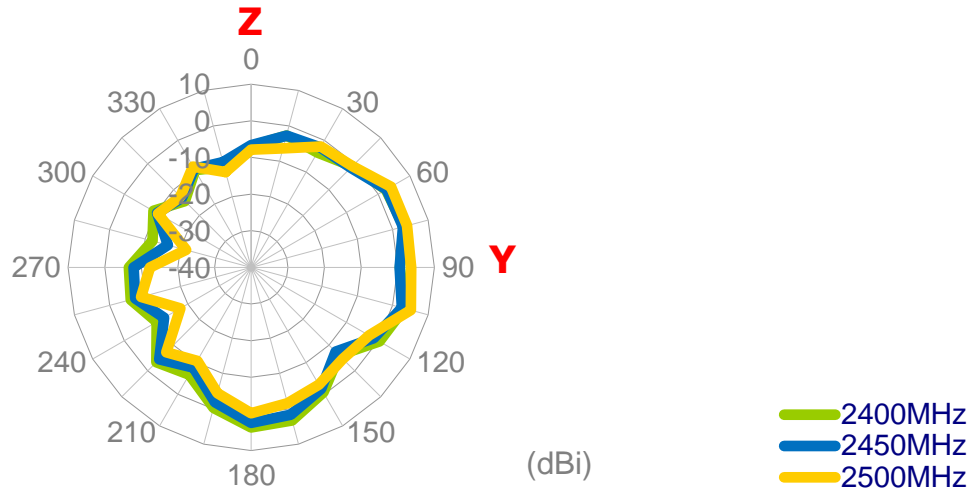

### 4.2.4 WI-FI MIMO2\_On 30x30cm GND

#### XY Plane

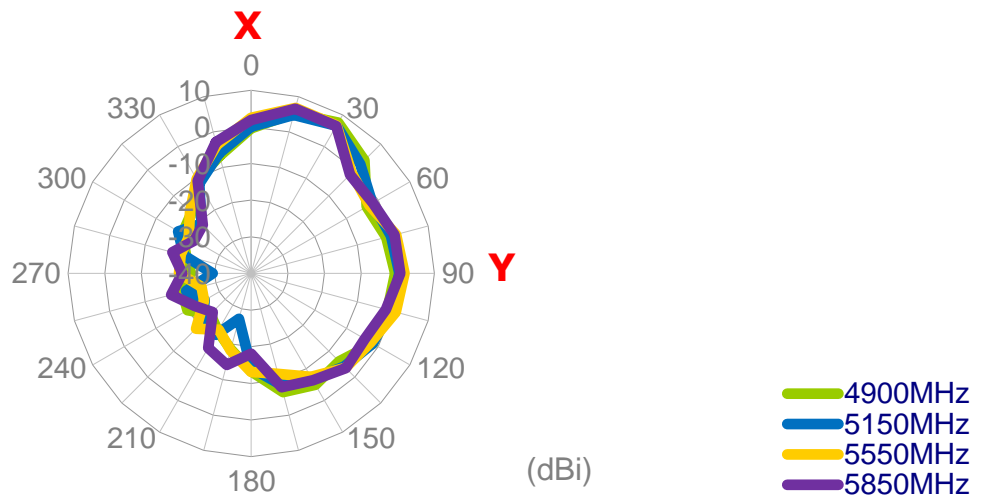
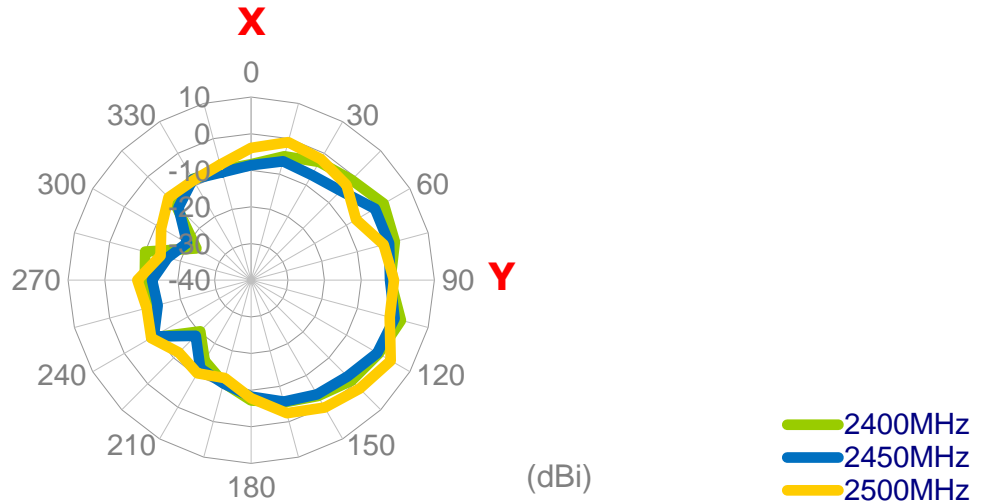

**XZ Plane**

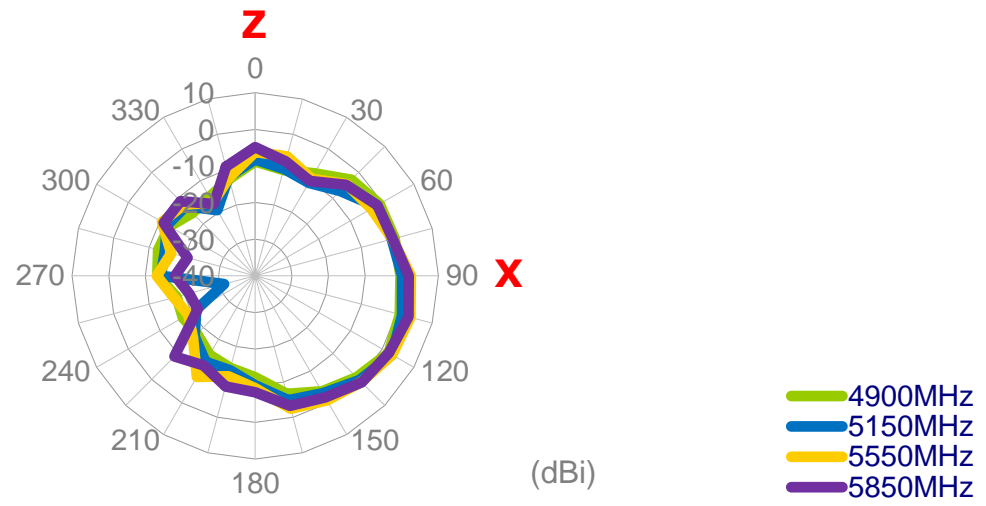
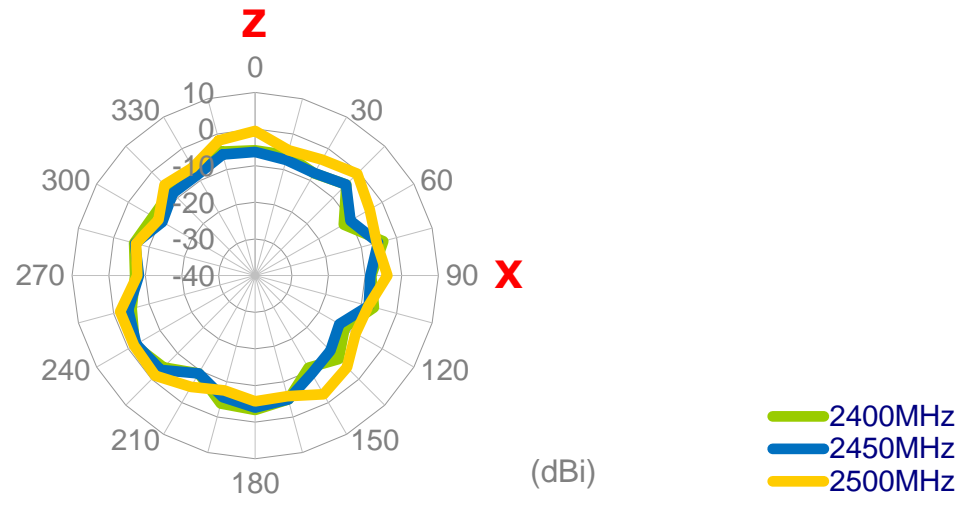

**YZ Plane**

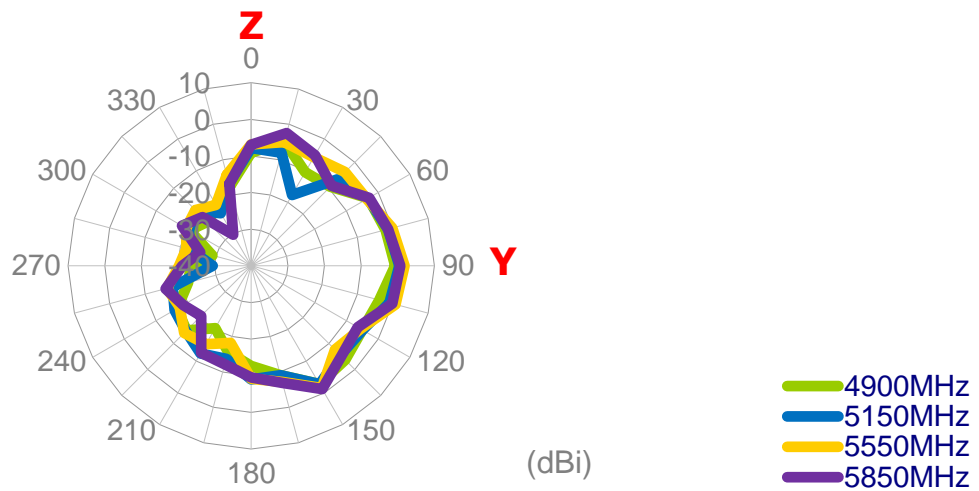
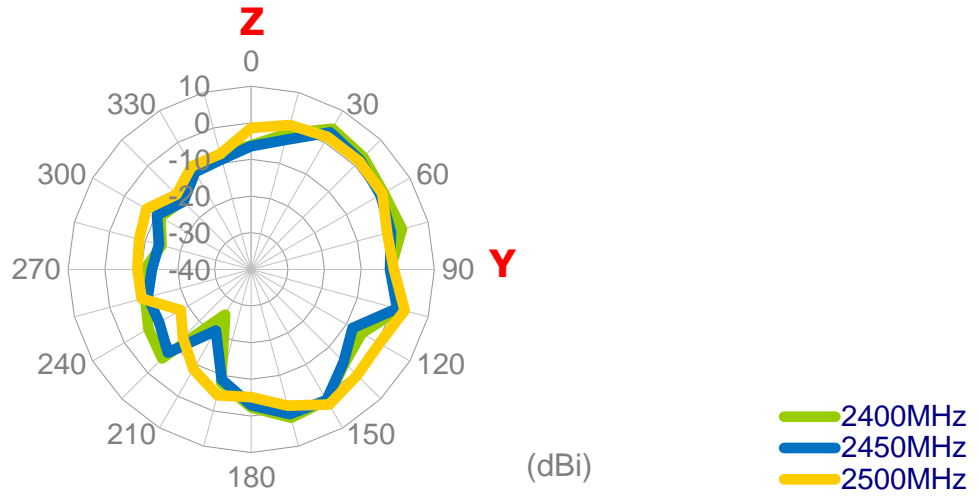

### 4.2.5 GNSS

#### XY Plane

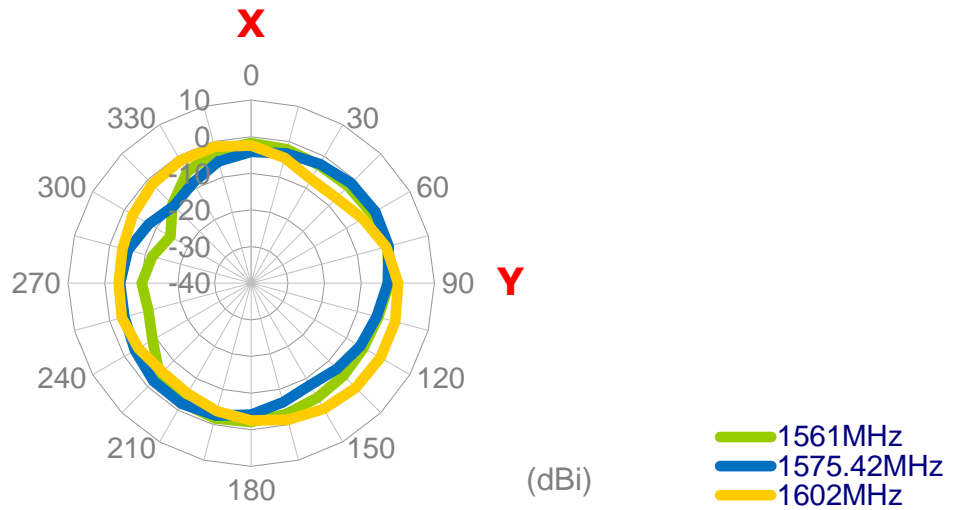

#### XZ Plane

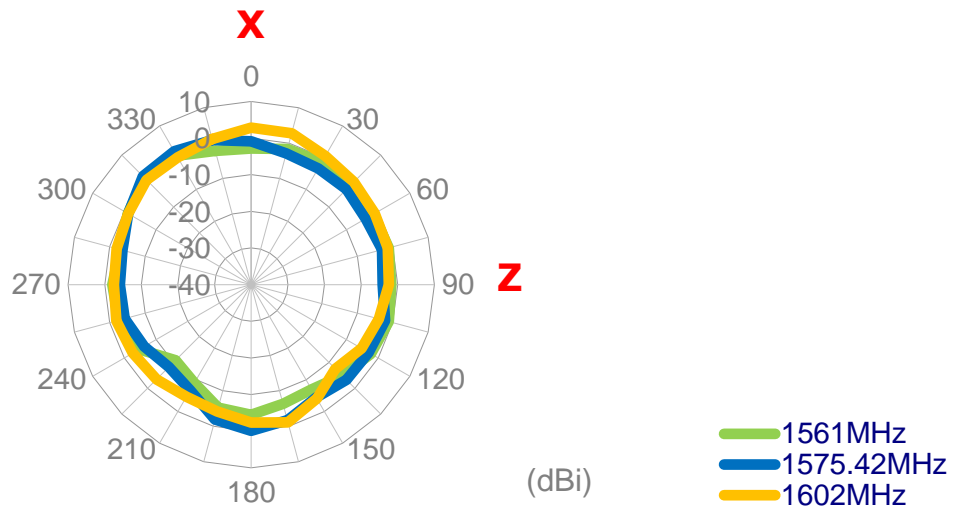

#### YZ Plane

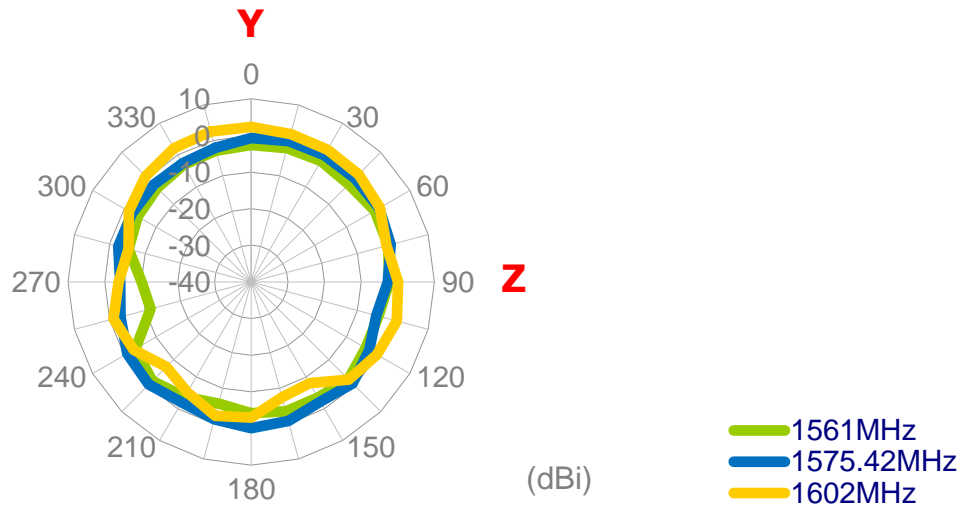



### 3D Radiation Patterns

#### 4.2.6 LTE MIMO1\_ On 30x30cm GND

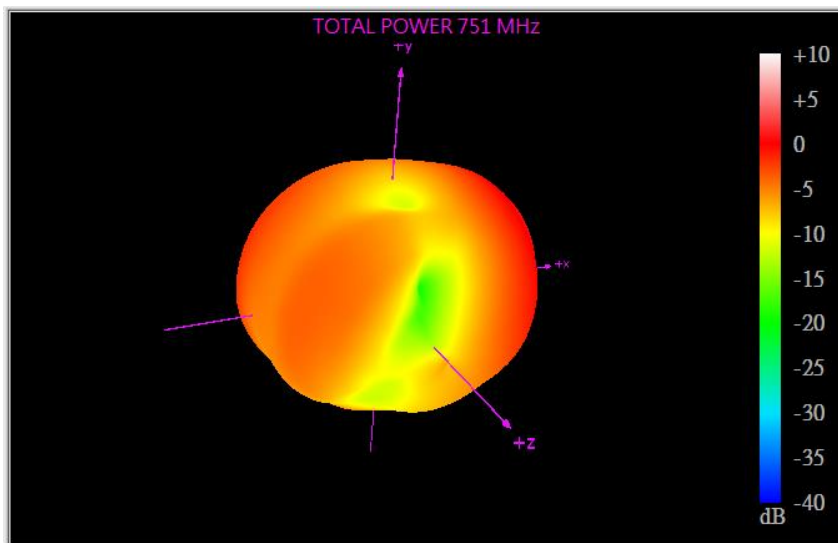
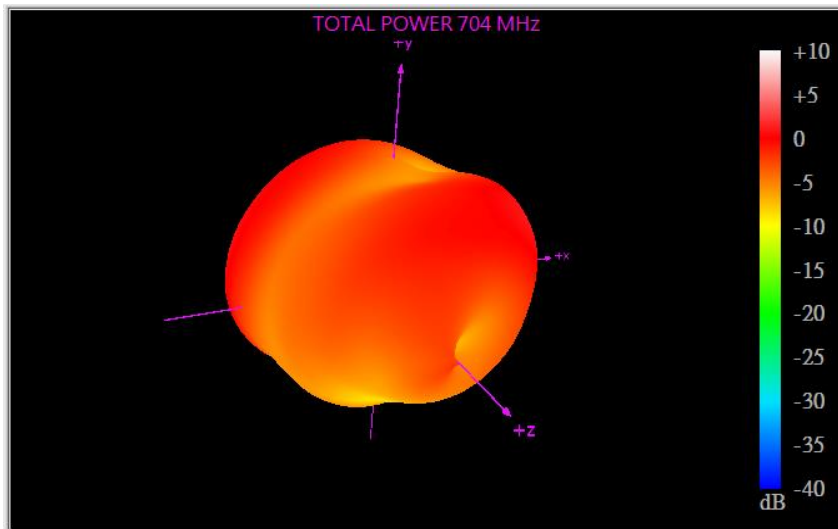
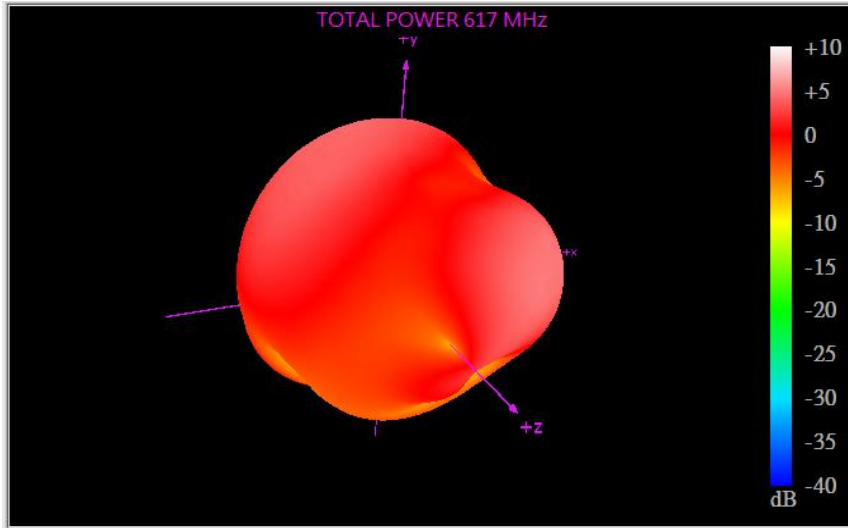

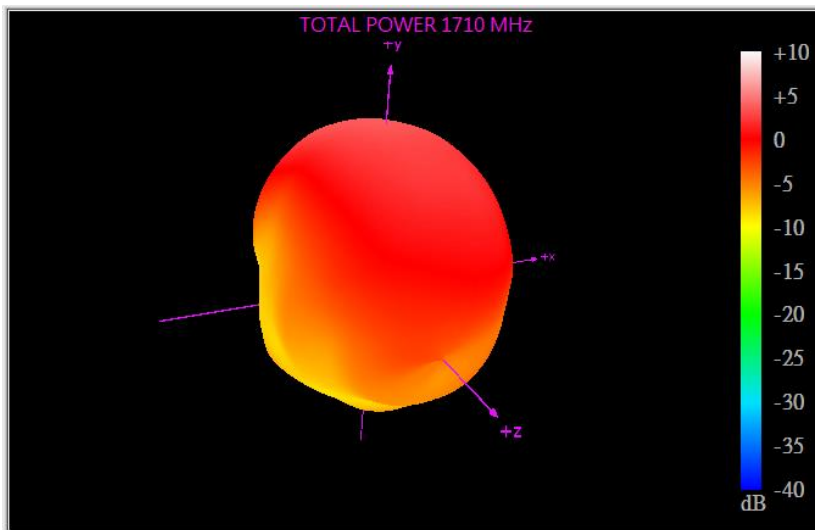
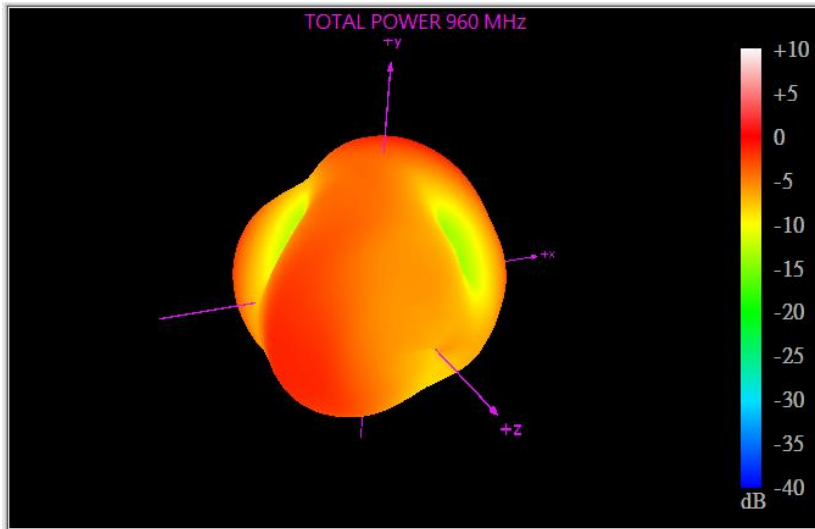
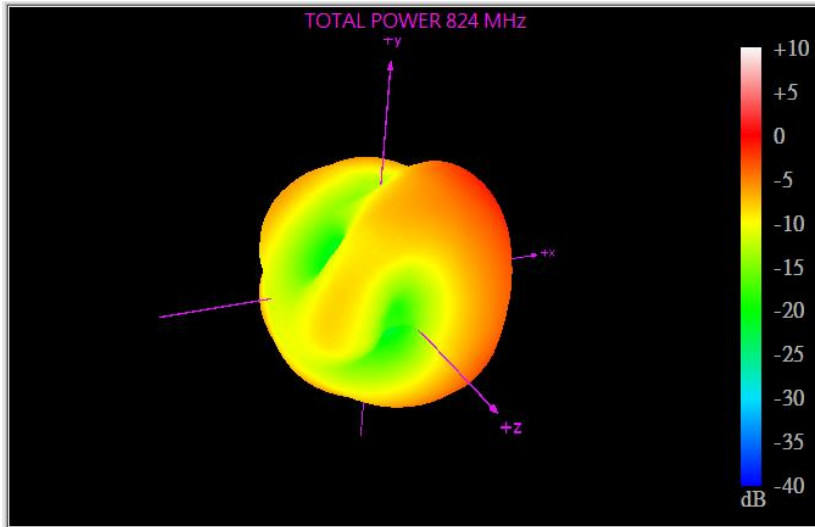

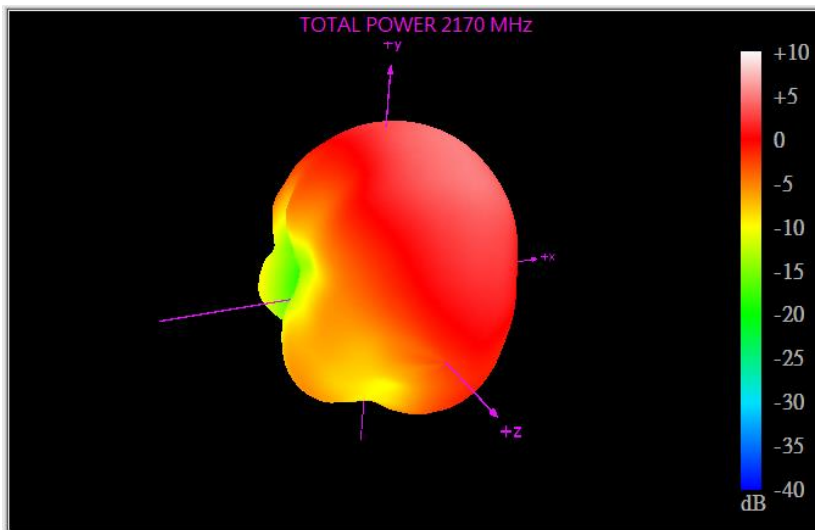
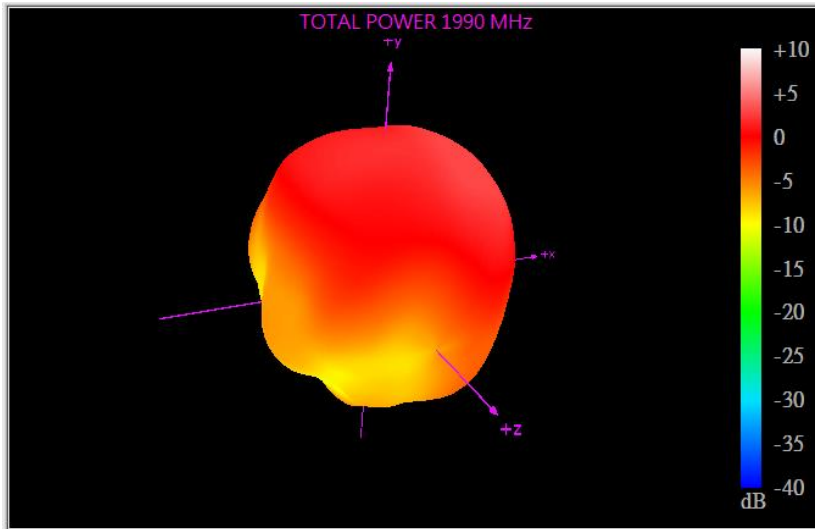
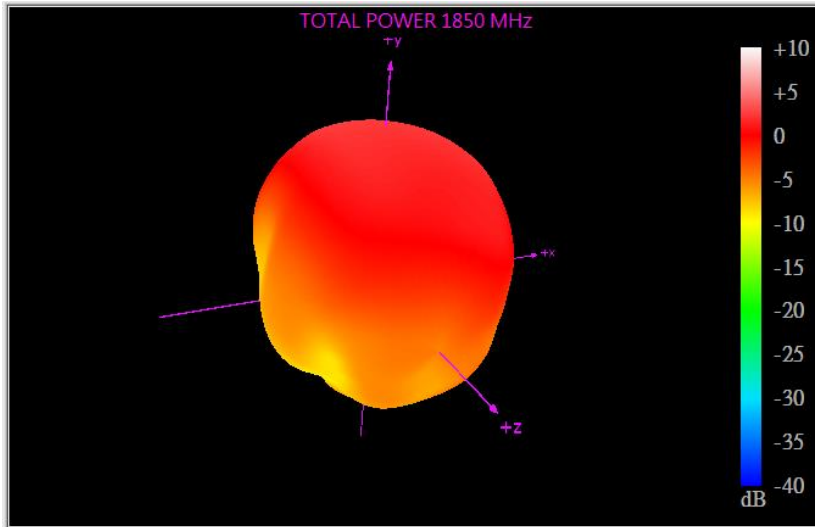

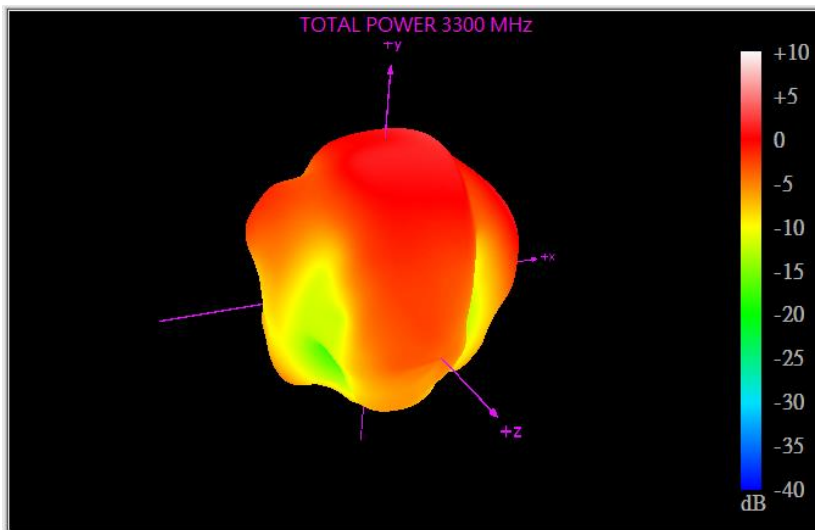
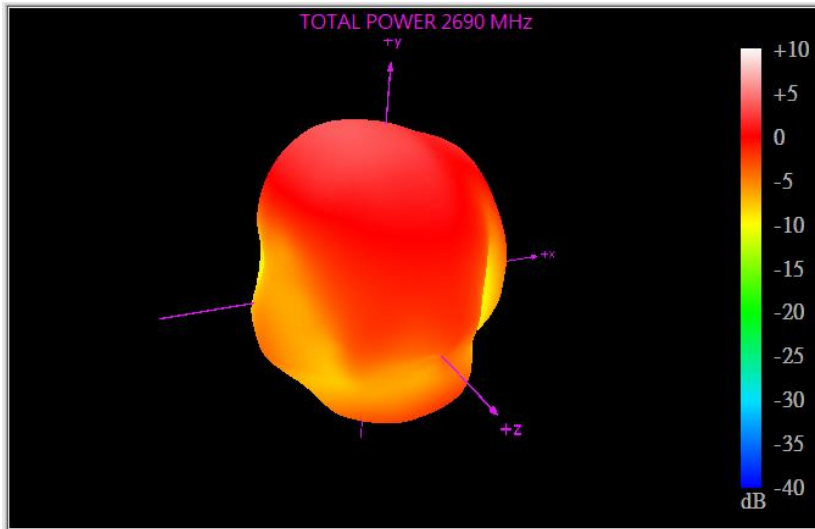
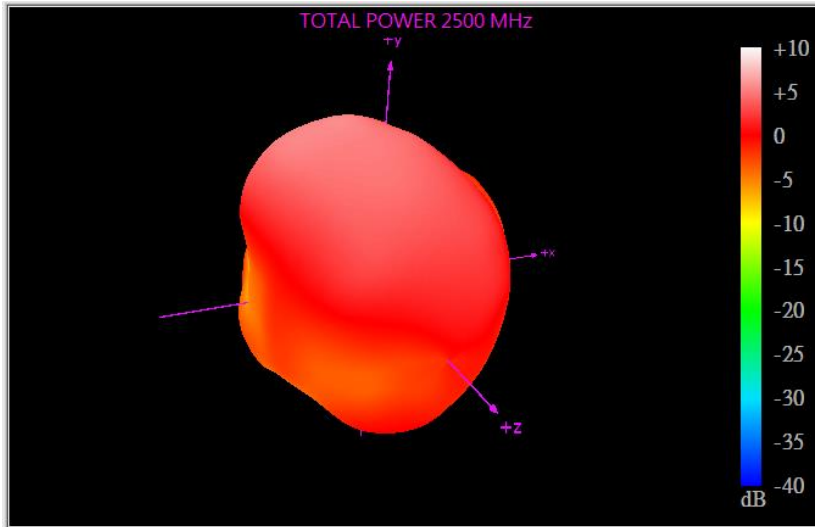

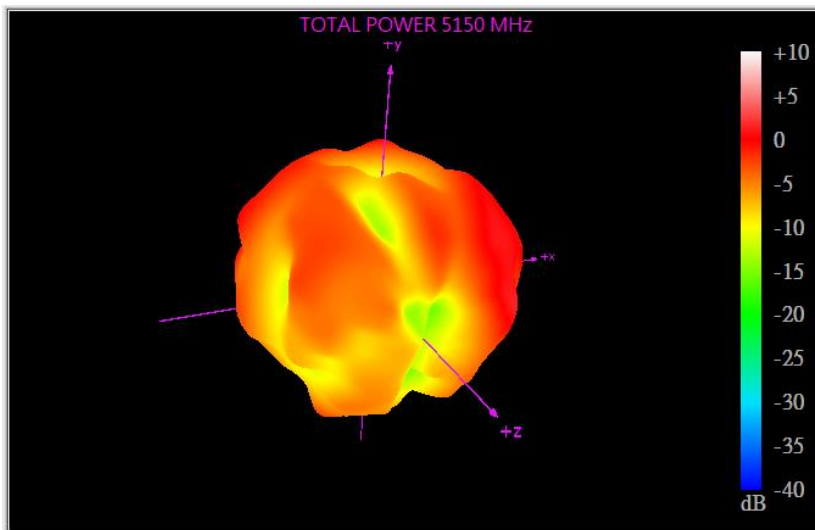
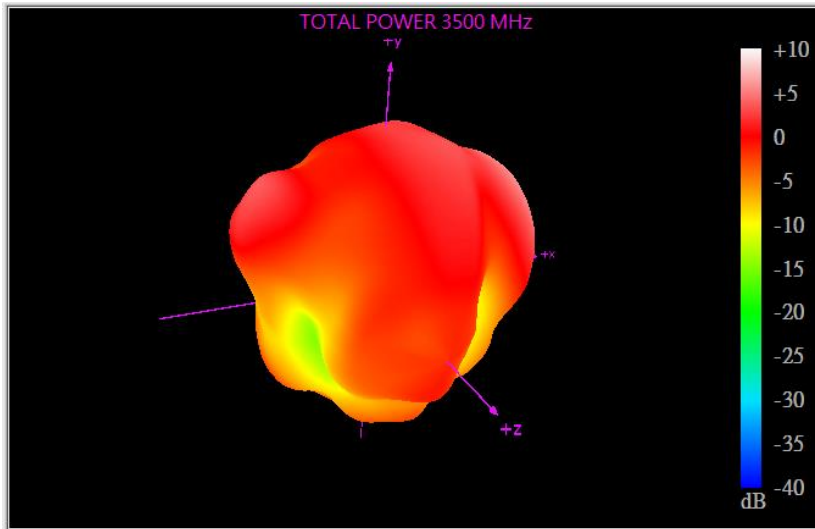
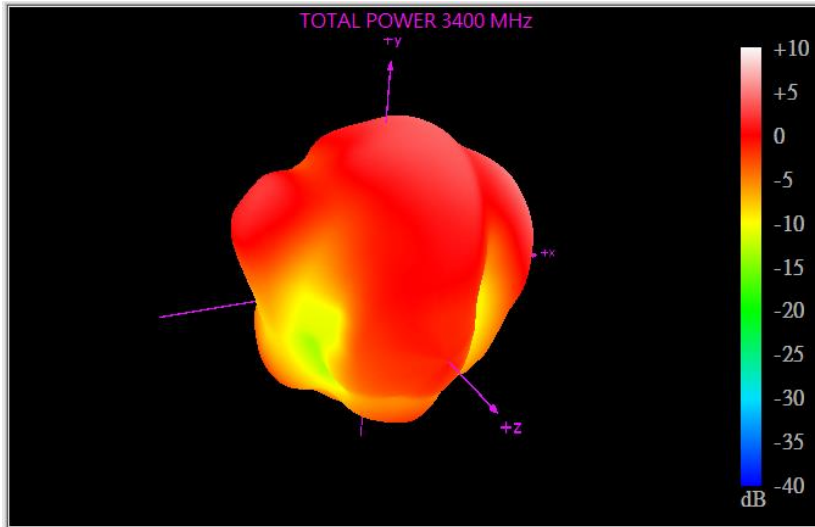

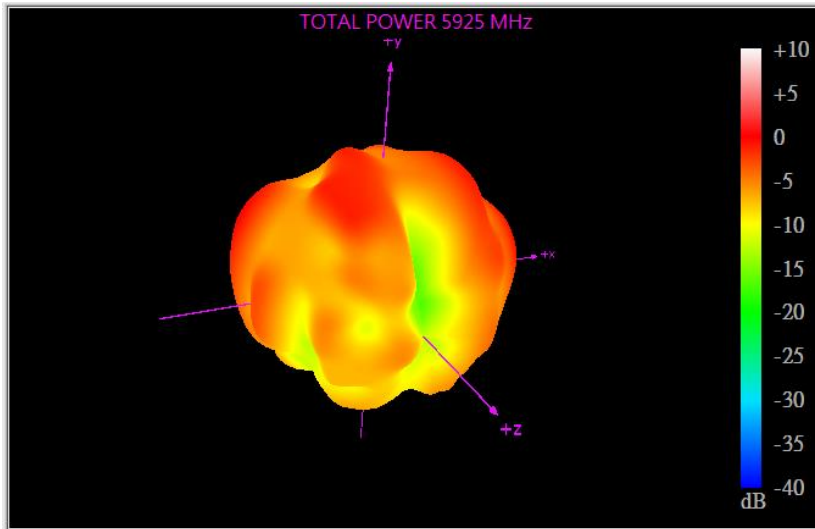
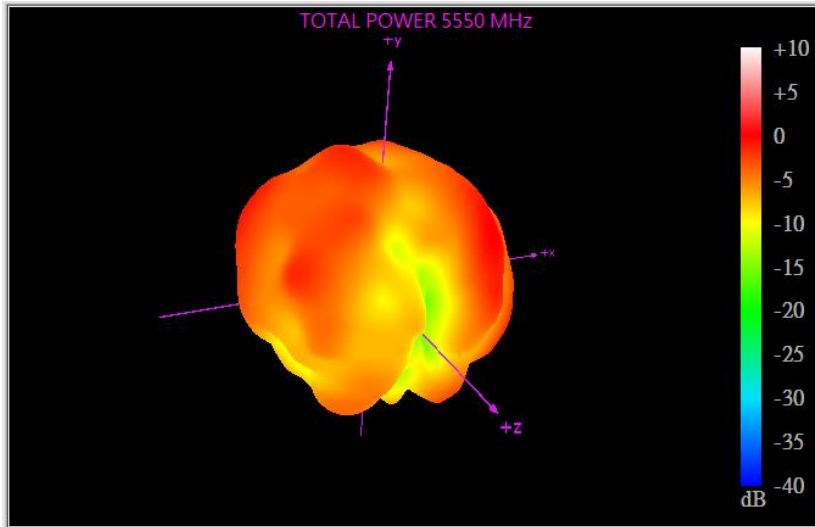

### 4.2.7 LTE MIMO2\_ On 30x30cm GND

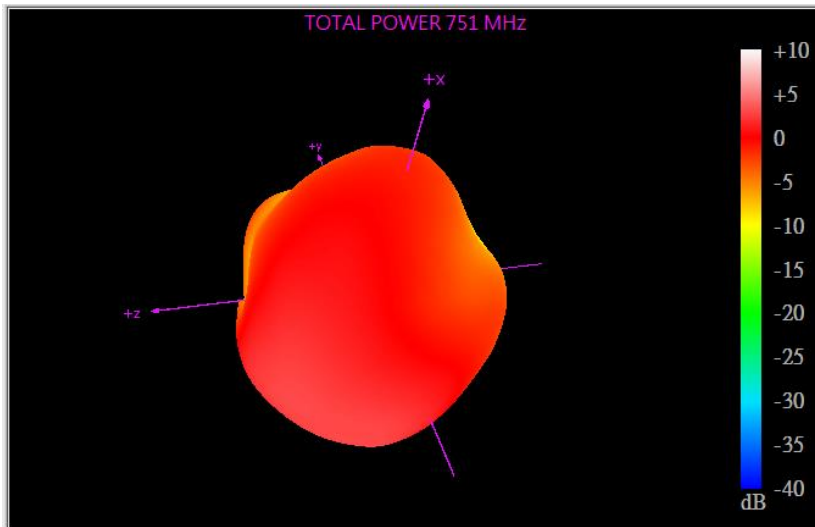
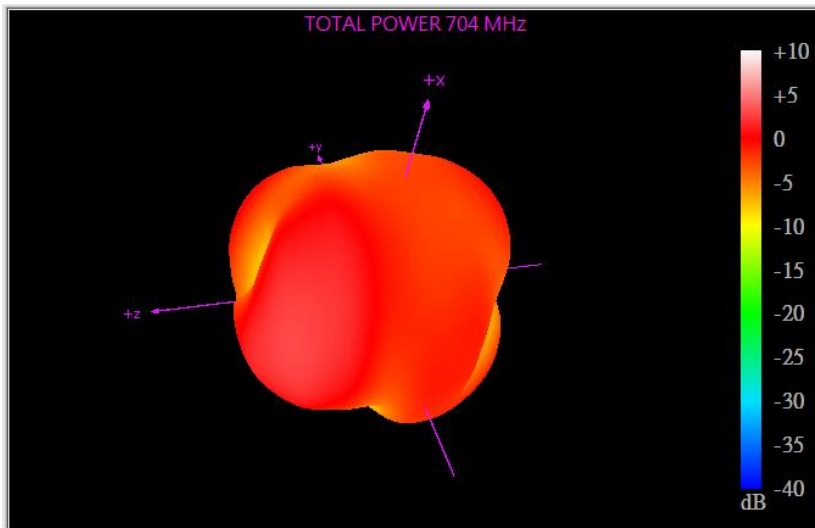
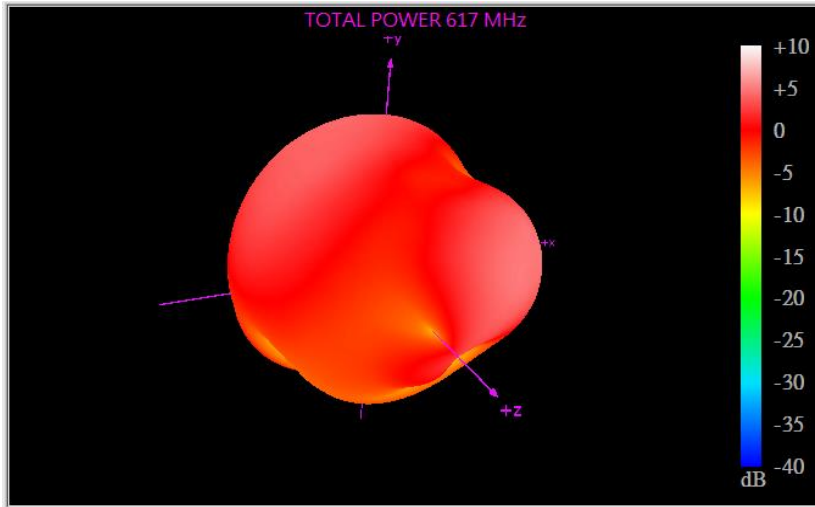

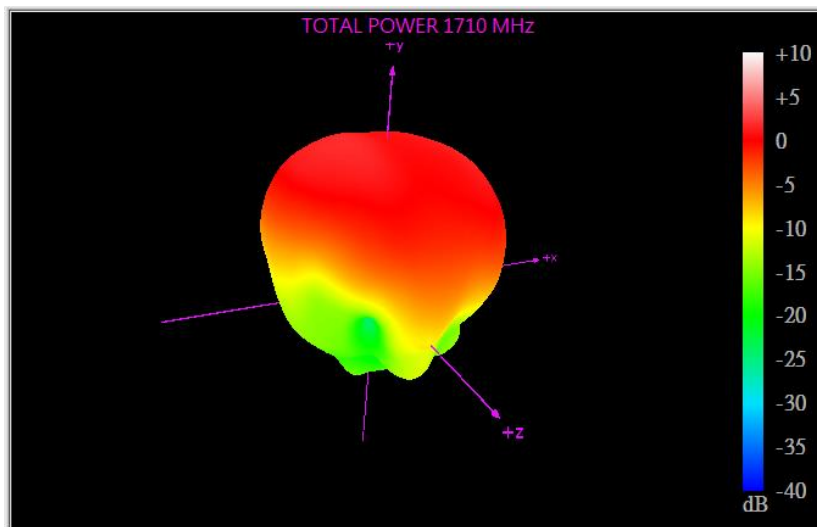
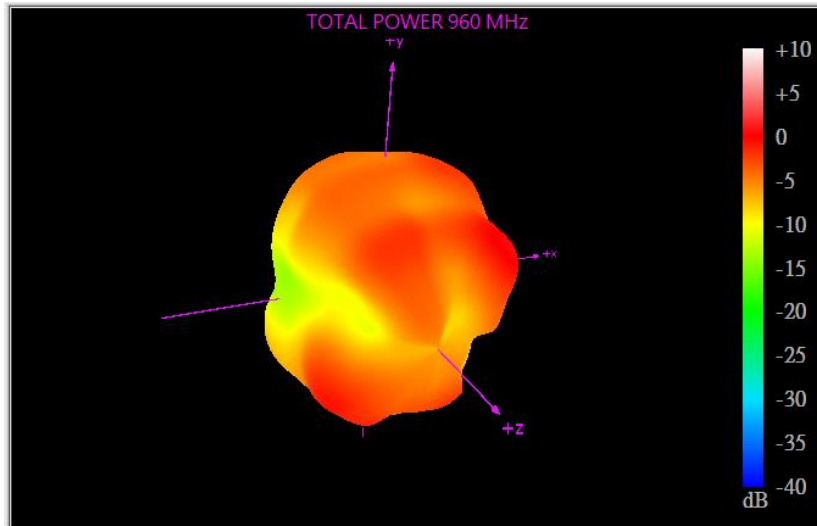
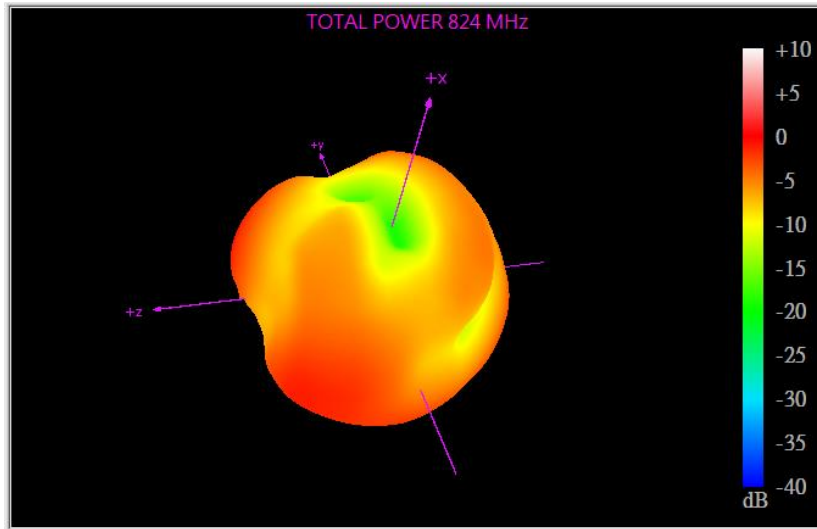



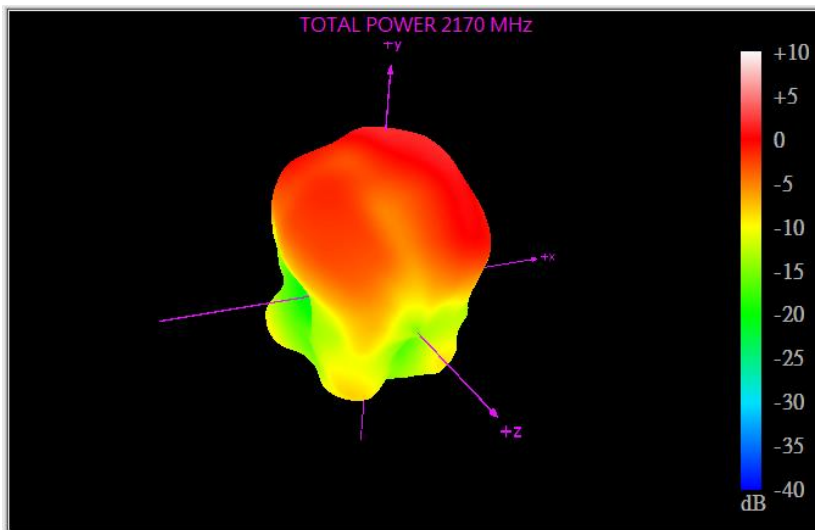
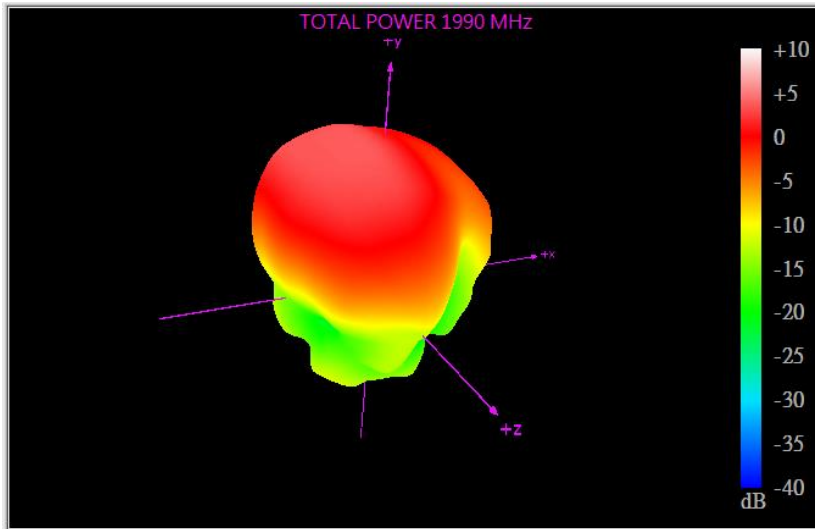
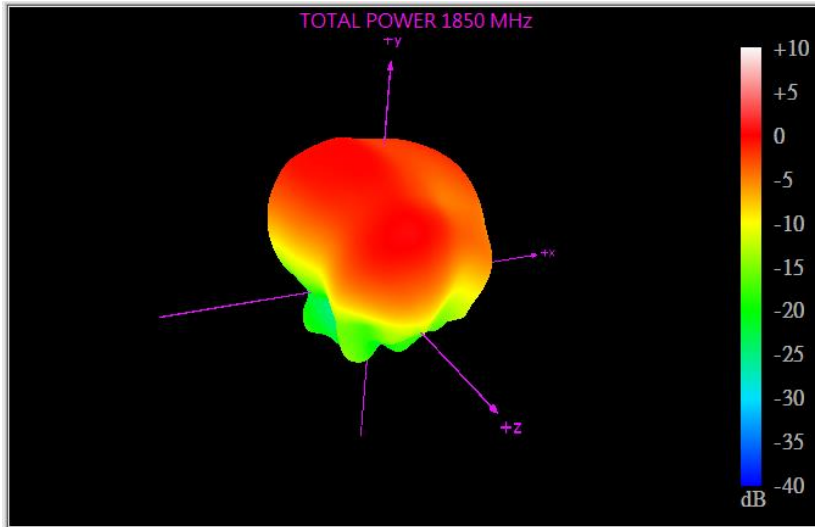

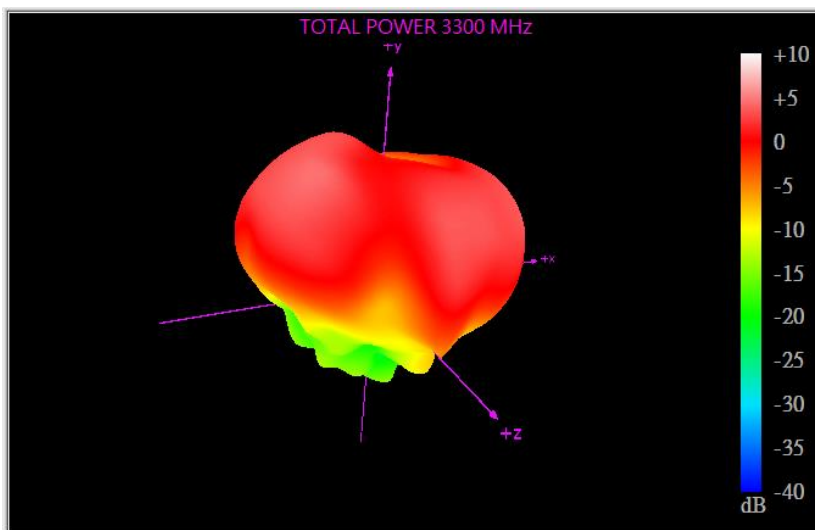
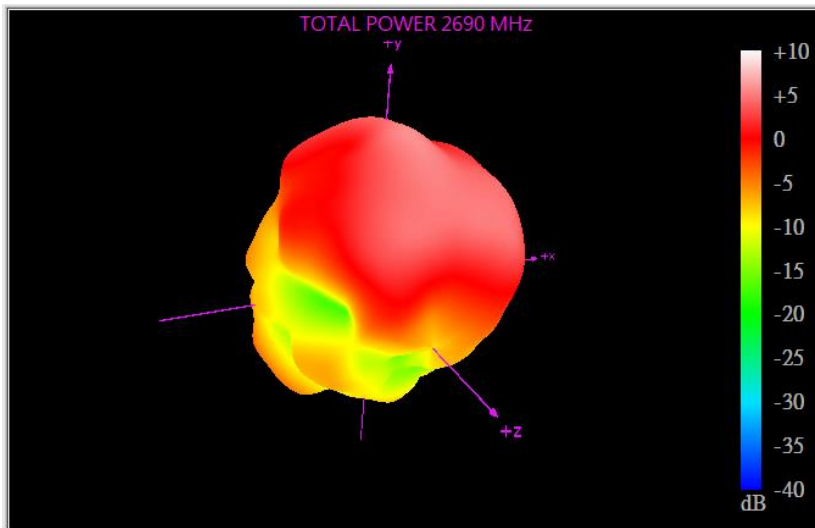
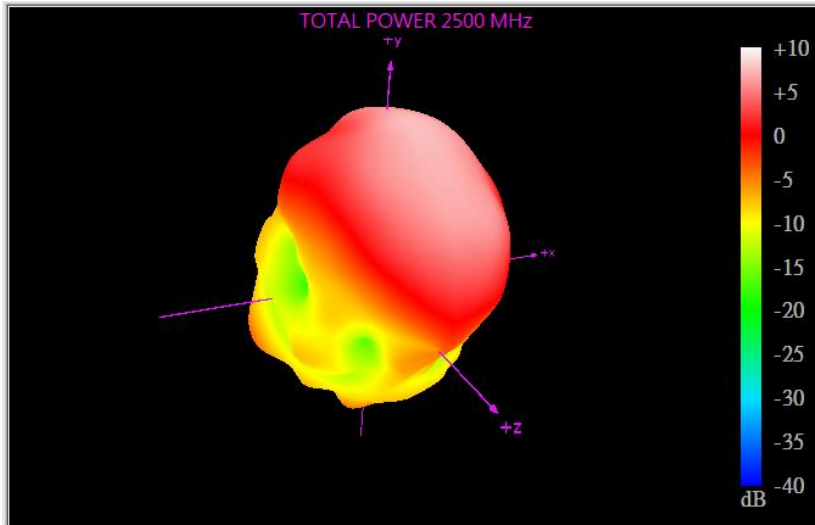

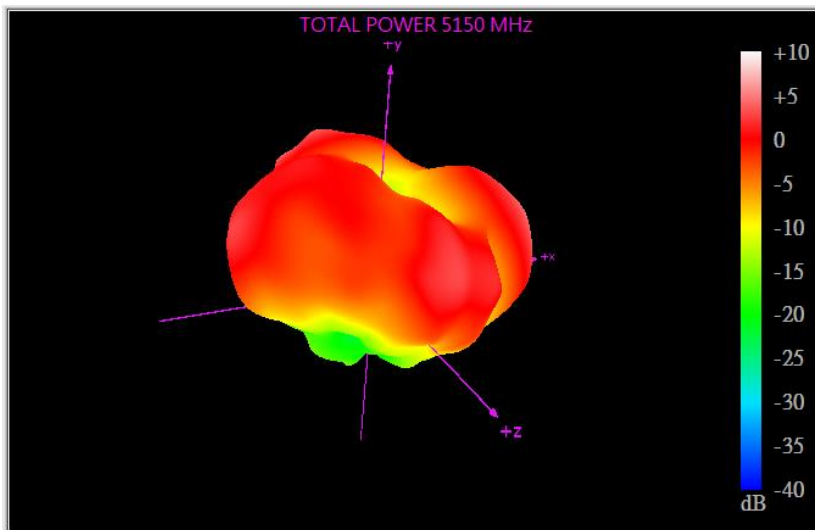
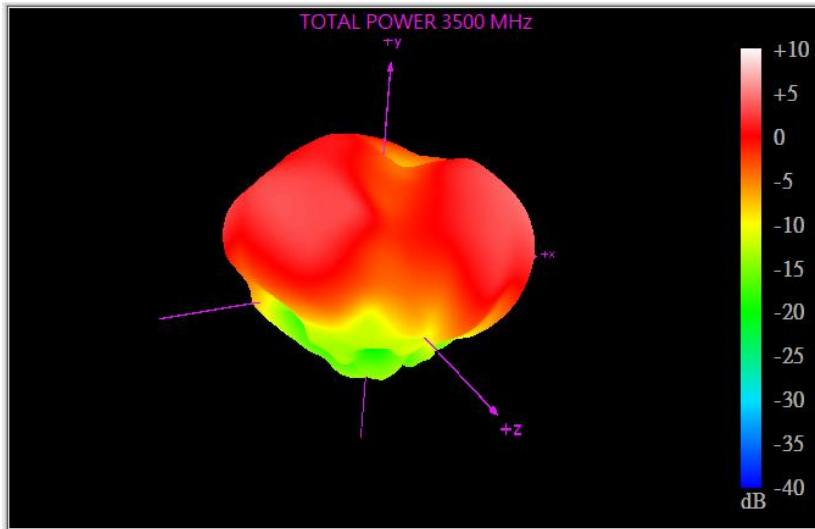
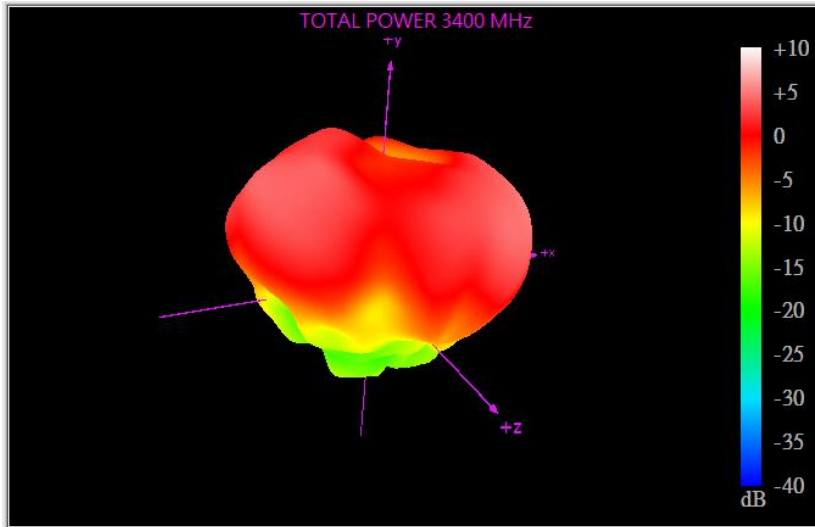

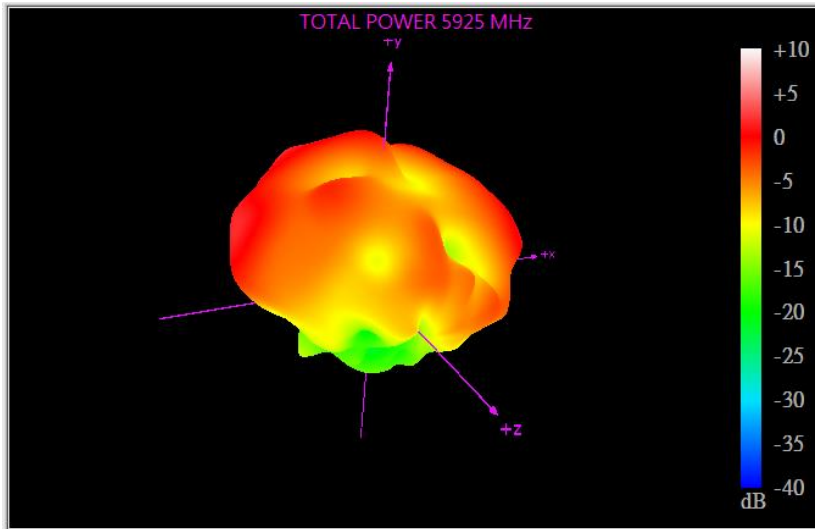
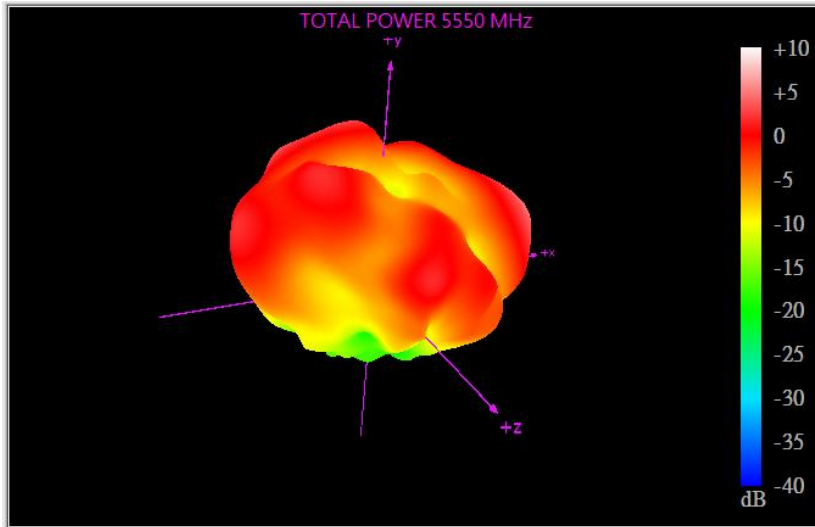

### 4.2.8 WI-FI MIMO1\_ On 30x30cm GND

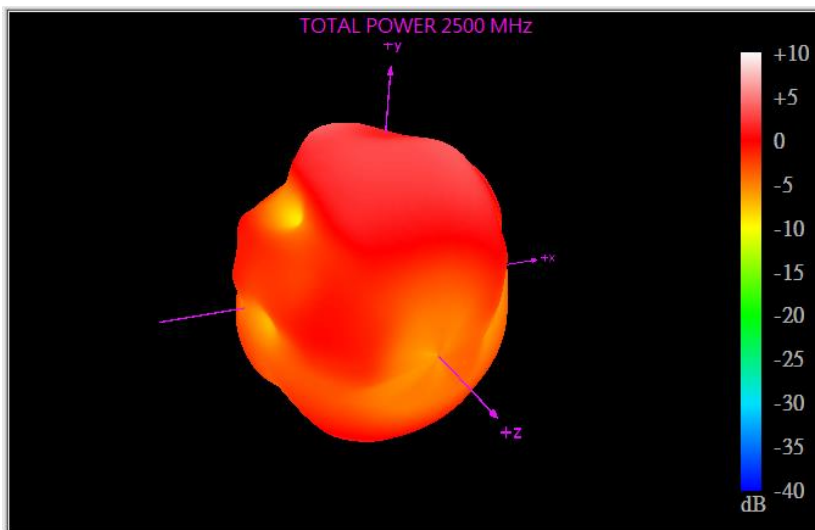
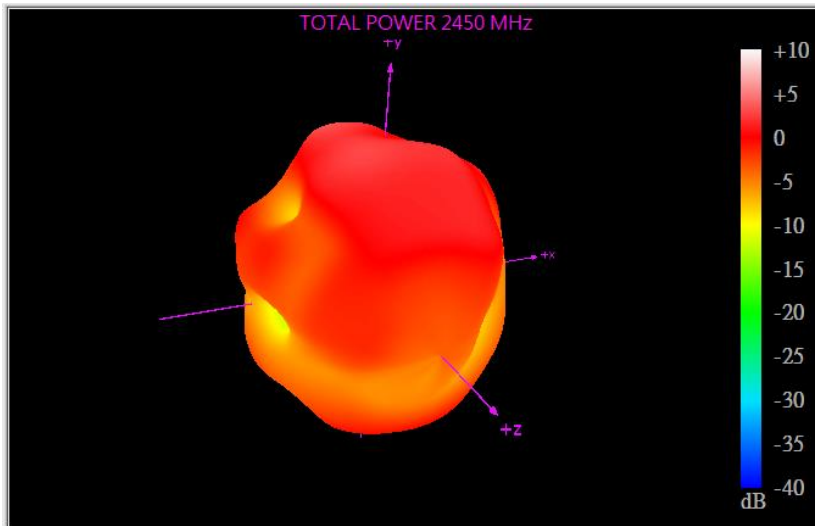
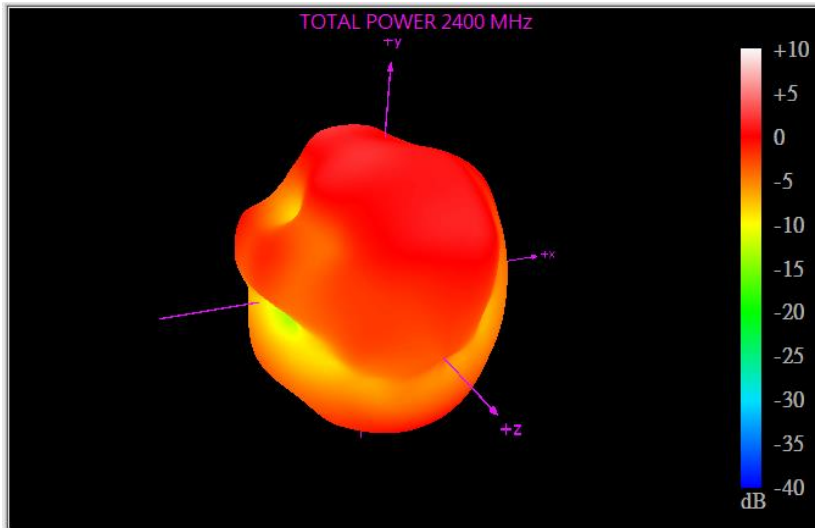

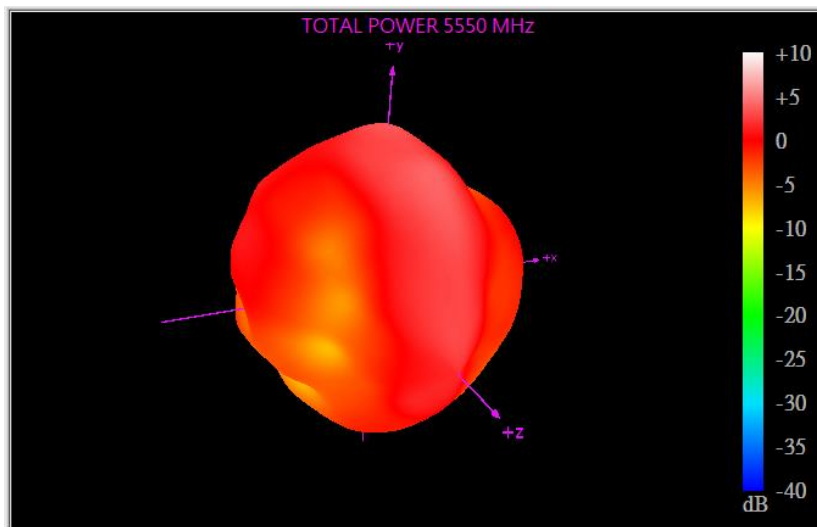
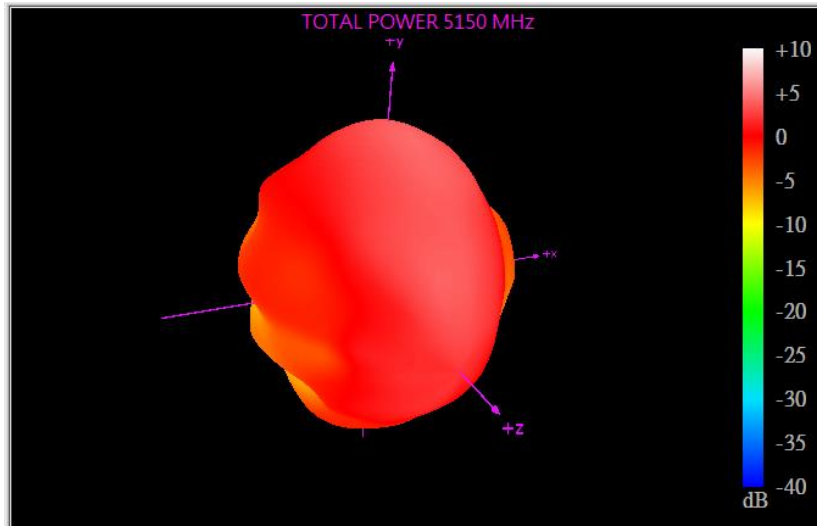
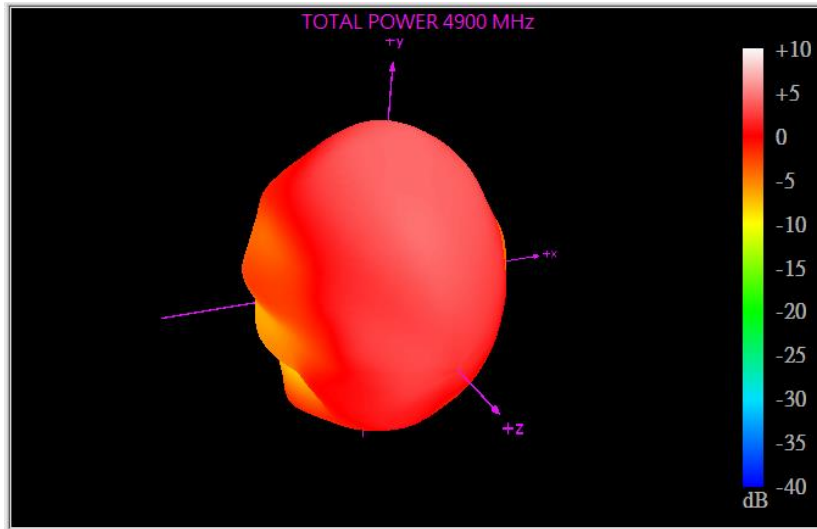

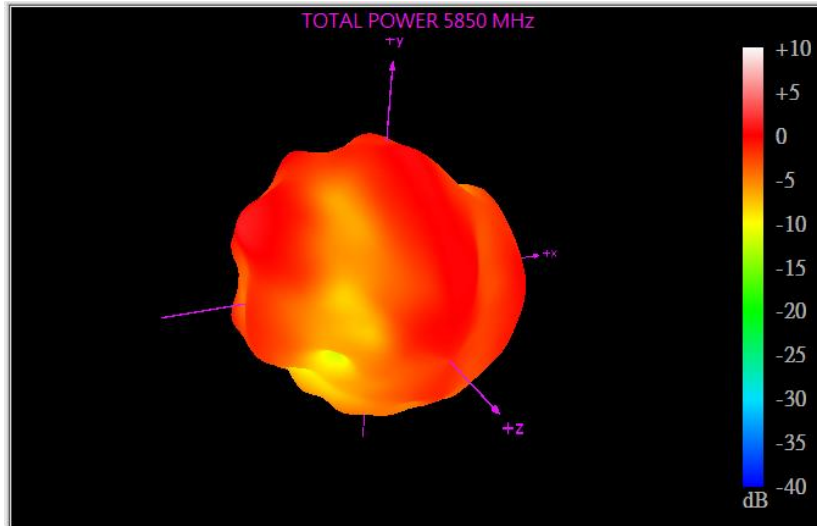

### 4.2.9 WI-FI MIMO2\_ On 30x30cm GND

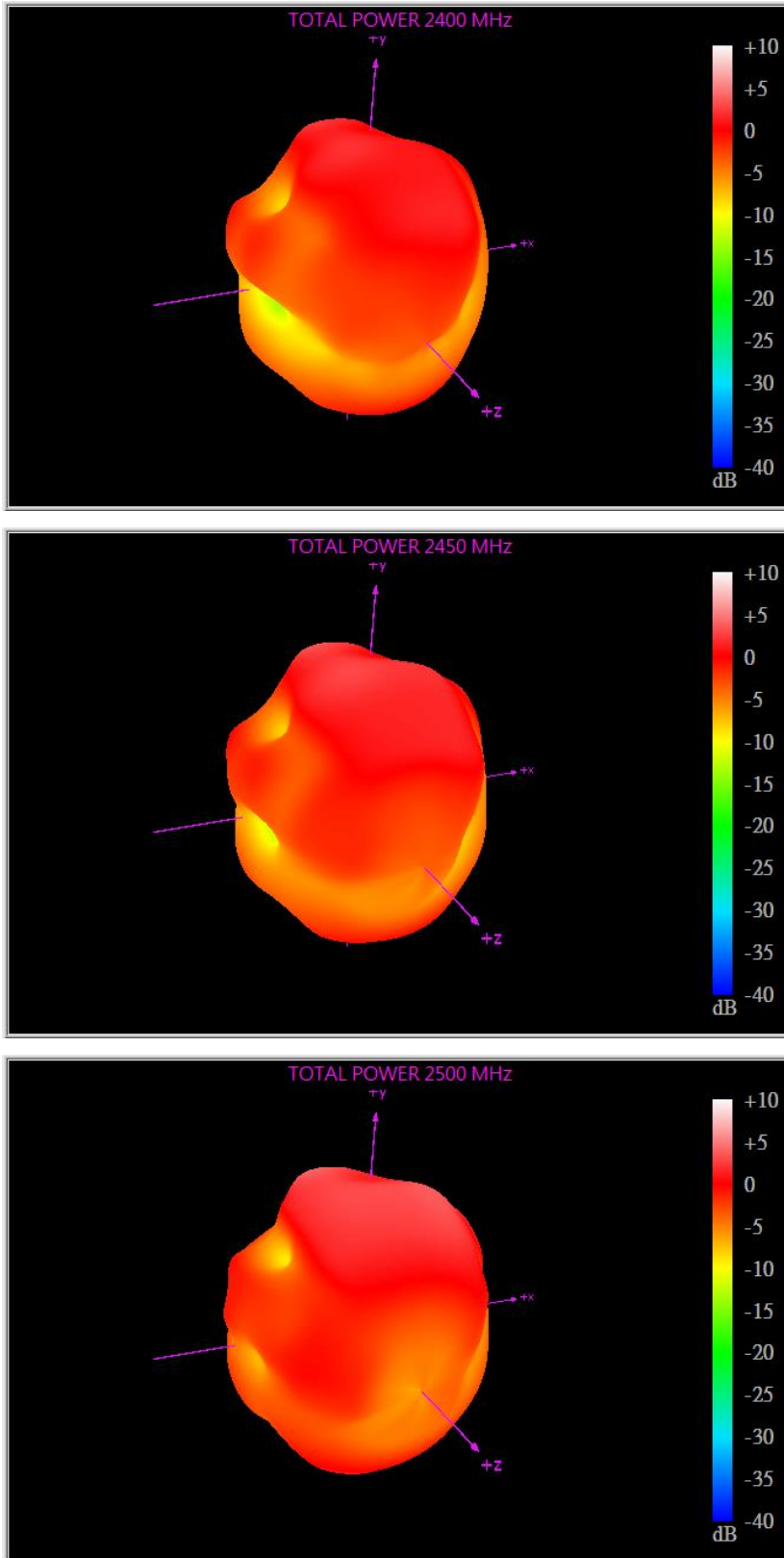



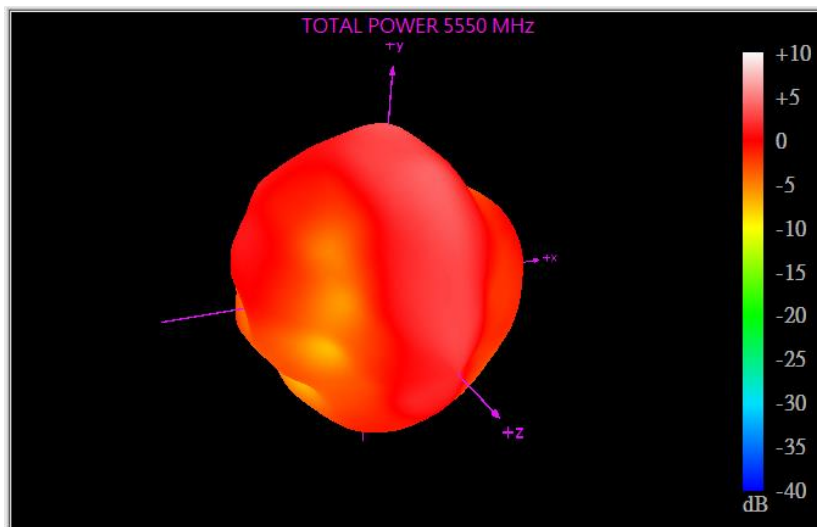
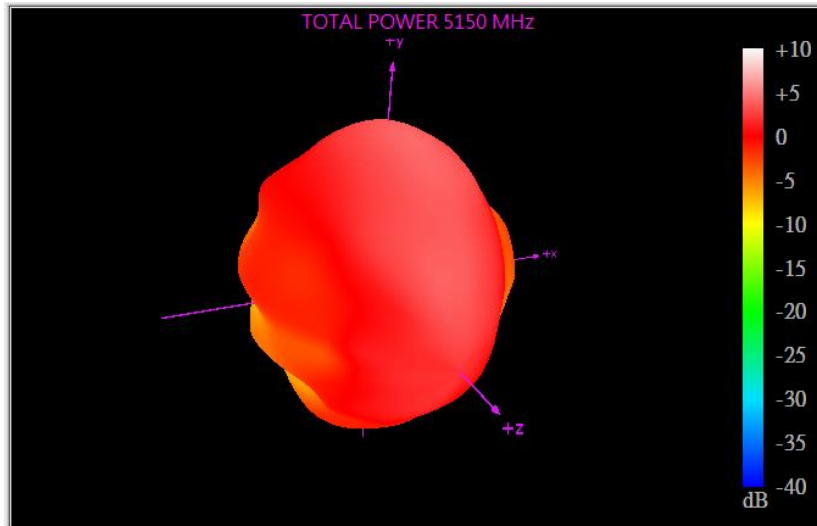
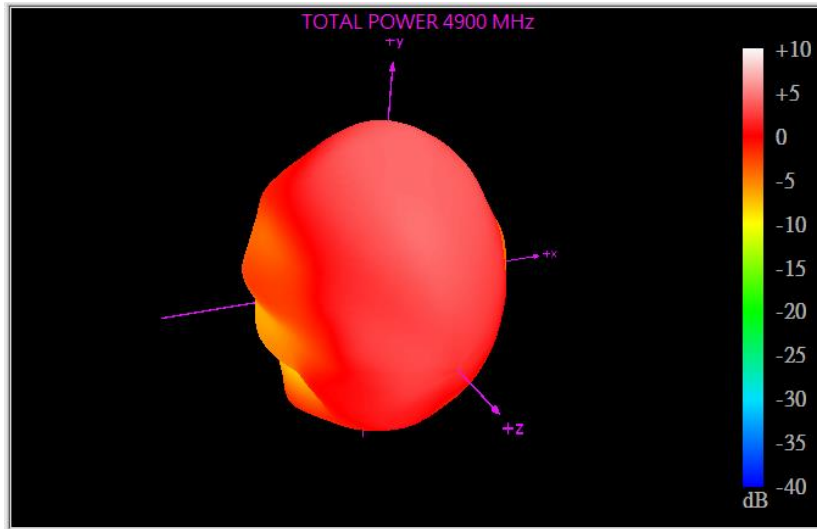

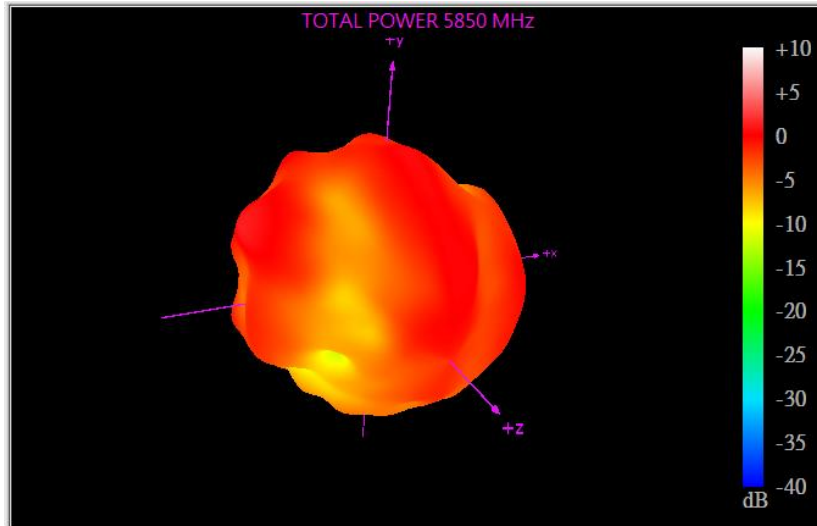

### 4.1.1 GNSS

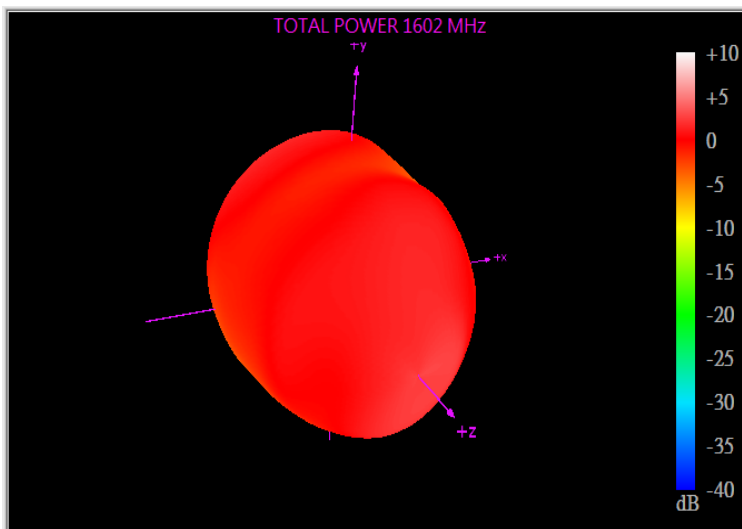
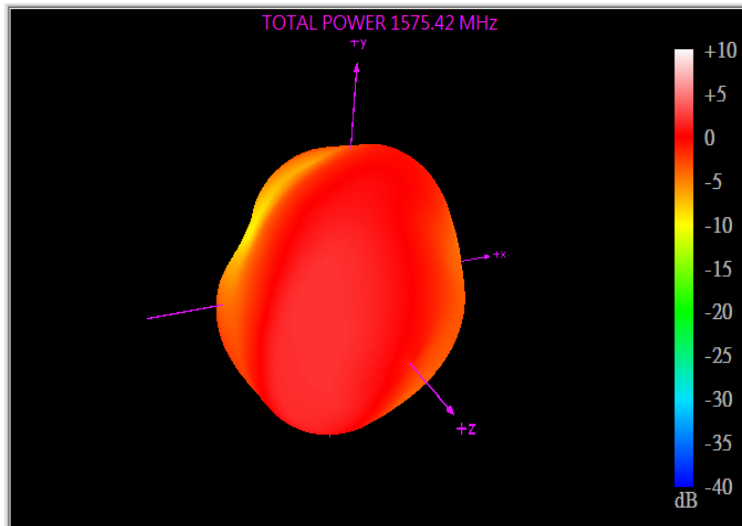
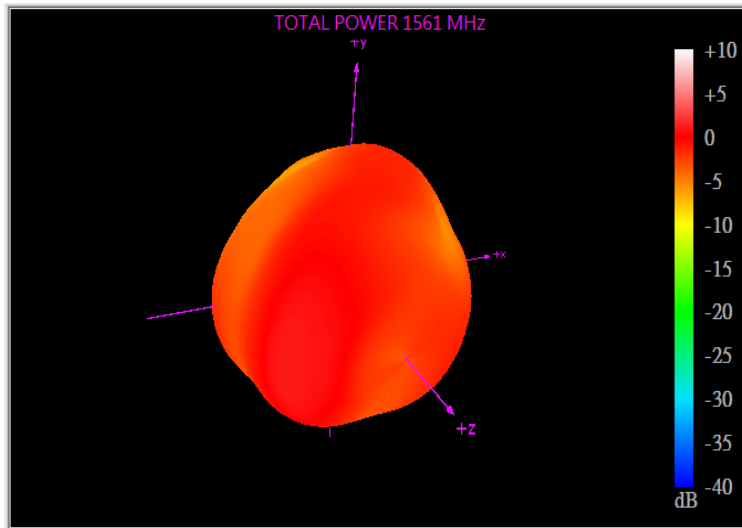

## 5. Mechanical Drawing (Unit: mm)

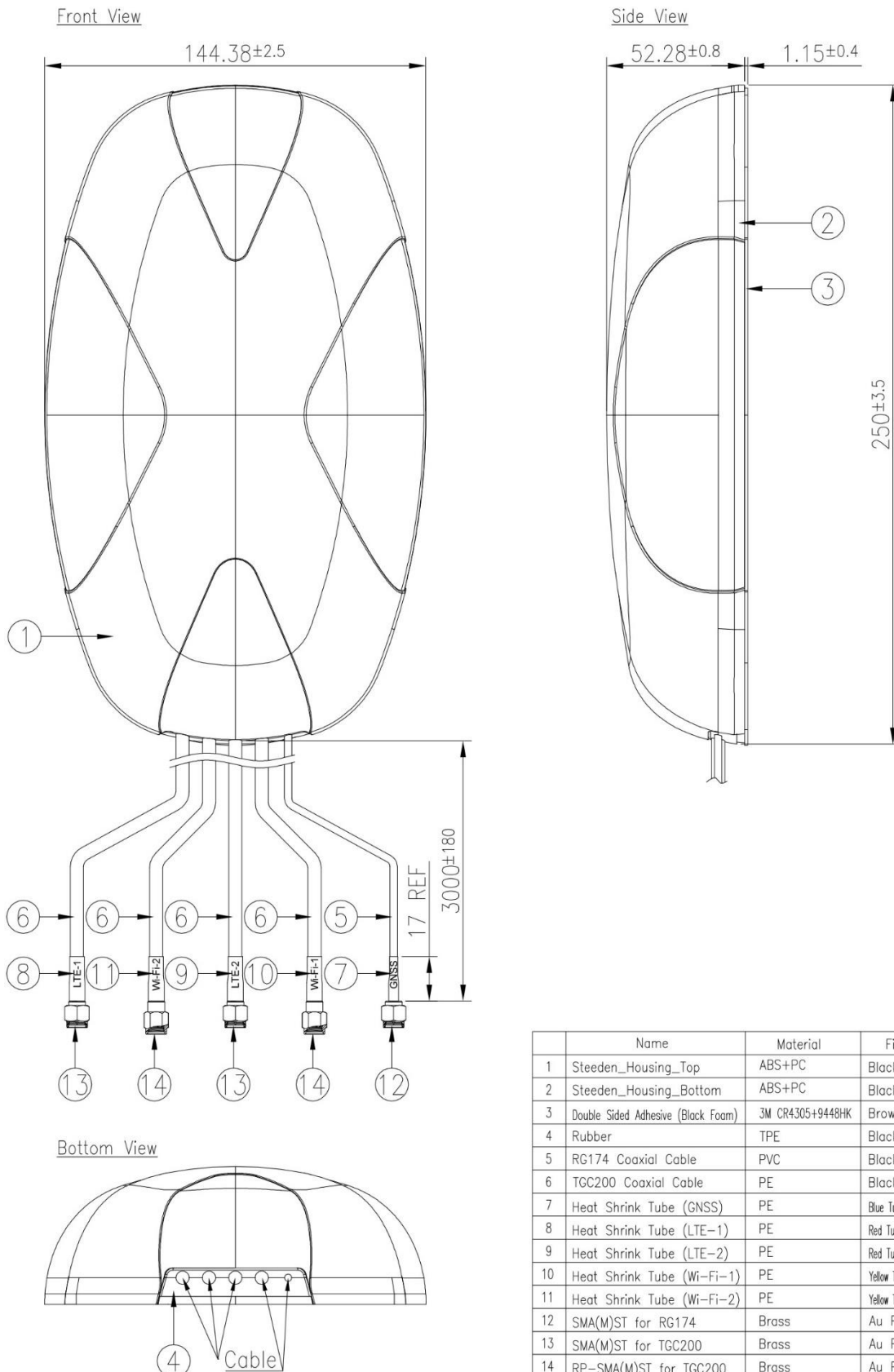

	Name	Material	Finish	QTY
1	Steeden_Housing_Top	ABS+PC	Black	1
2	Steeden_Housing_Bottom	ABS+PC	Black	1
3	Double Sided Adhesive (Black Foam)	3M CR4305+9448HK	Brown Liner	1
4	Rubber	TPE	Black	1
5	RG174 Coaxial Cable	PVC	Black	1
6	TGC200 Coaxial Cable	PE	Black	4
7	Heat Shrink Tube (GNSS)	PE	Blue Tube/White Text	1
8	Heat Shrink Tube (LTE-1)	PE	Red Tube/White Text	1
9	Heat Shrink Tube (LTE-2)	PE	Red Tube/White Text	1
10	Heat Shrink Tube (Wi-Fi-1)	PE	Yellow Tube/Black Text	1
11	Heat Shrink Tube (Wi-Fi-2)	PE	Yellow Tube/Black Text	1
12	SMA(M)ST for RG174	Brass	Au Plated	1
13	SMA(M)ST for TGC200	Brass	Au Plated	2
14	RP-SMA(M)ST for TGC200	Brass	Au Plated	2

## 6. Packaging

1pc FMA359.A.LBICG.001 per PE Bag  
PE Bag Dimensions - 300\*150mm  
Weight - 0.55Kg

12 PE Bags per Carton  
Box Dimensions - 549\*520\*370mm  
Weight - 6.6Kg

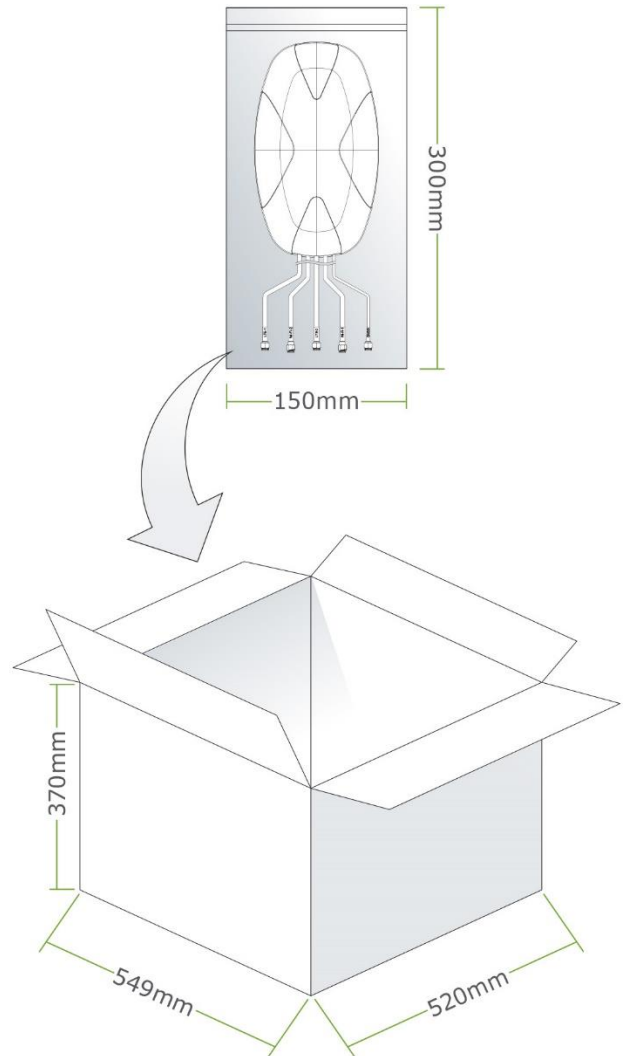

## 7. Application Note

The FMA359 antenna performance with different cable lengths is shown below.

### 7.1. Return Loss

#### Return Loss – LTE MIMO1 Antenna (On 30\*30cm GND)

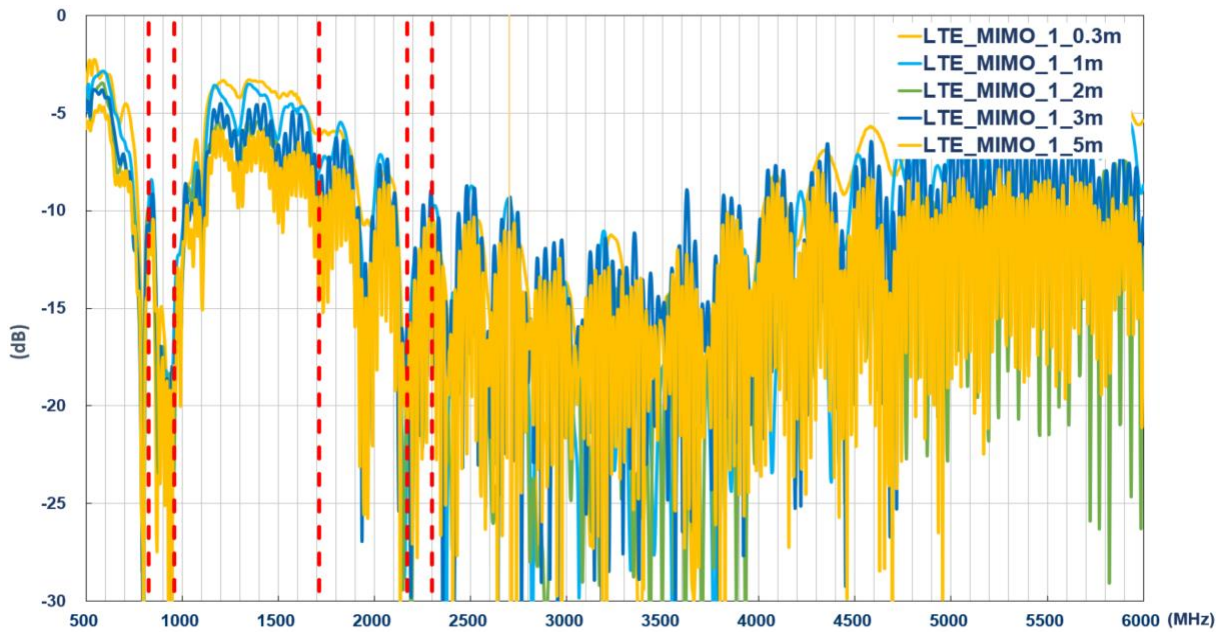

#### Return Loss – LTE MIMO2 Antenna (On 30\*30cm GND)

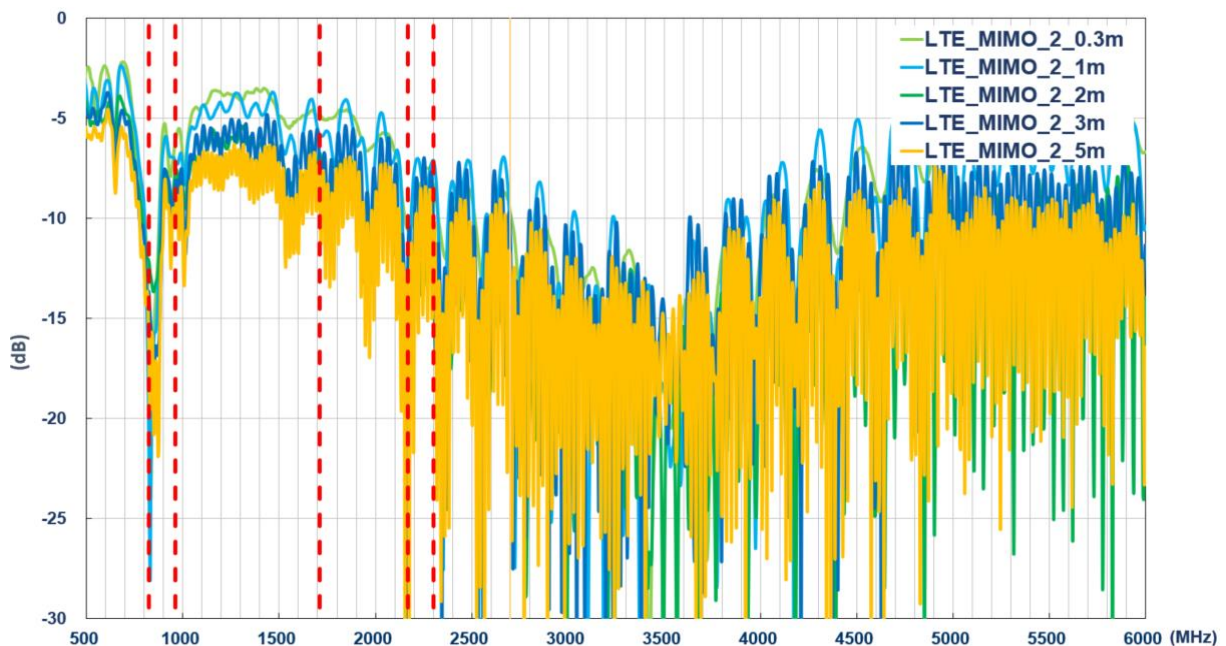

### Return Loss – WI-FI MIMO1 Antenna (On 30\*30cm GND)

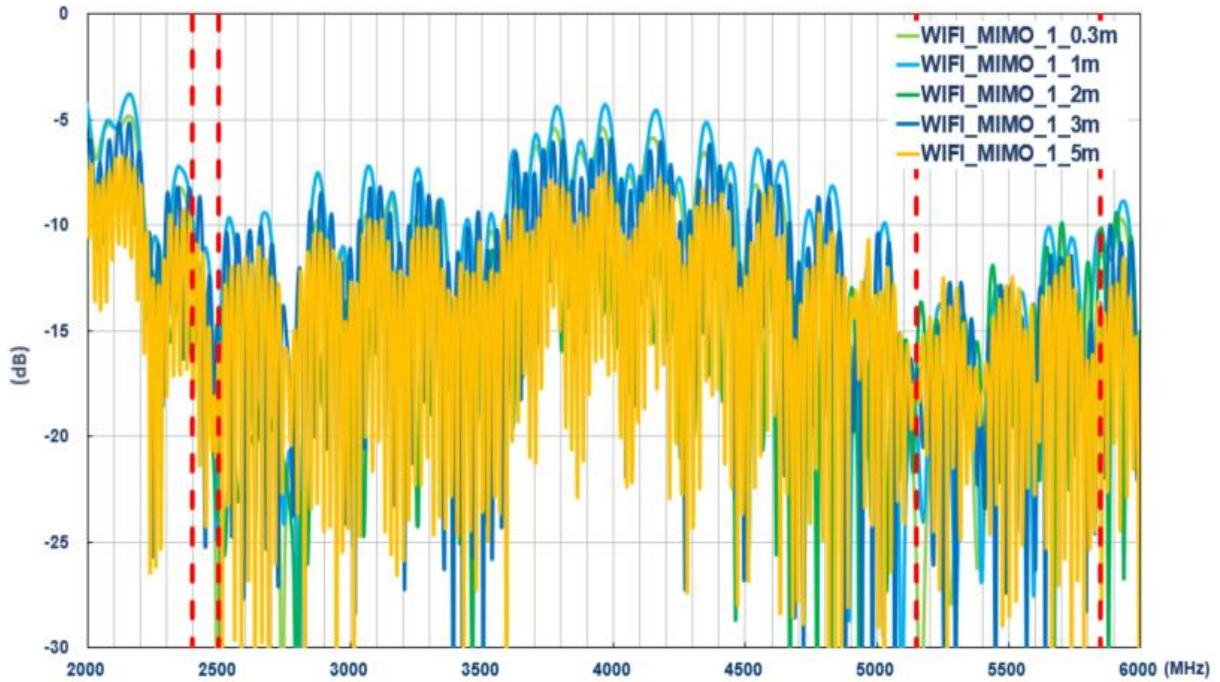

### Return Loss – WI-FI MIMO2 Antenna (On 30\*30cm GND)

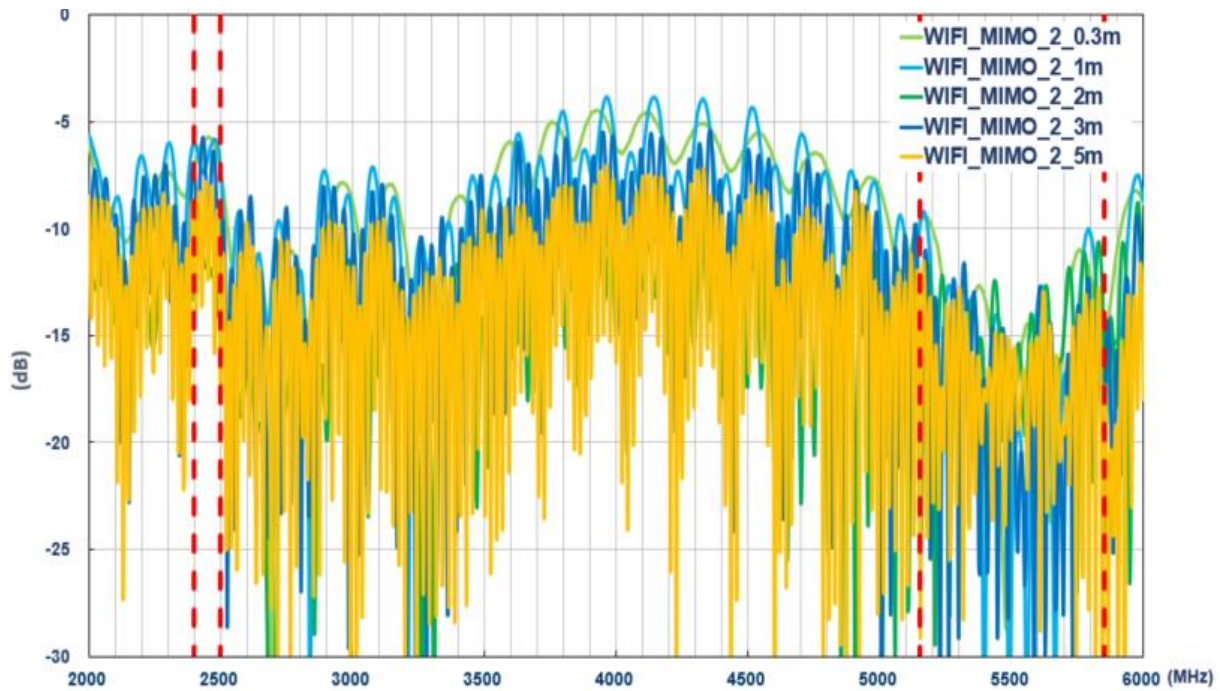

## 7.2. Efficiency

### Efficiency – LTE MIMO1 Antenna (On 30\*30cm GND)

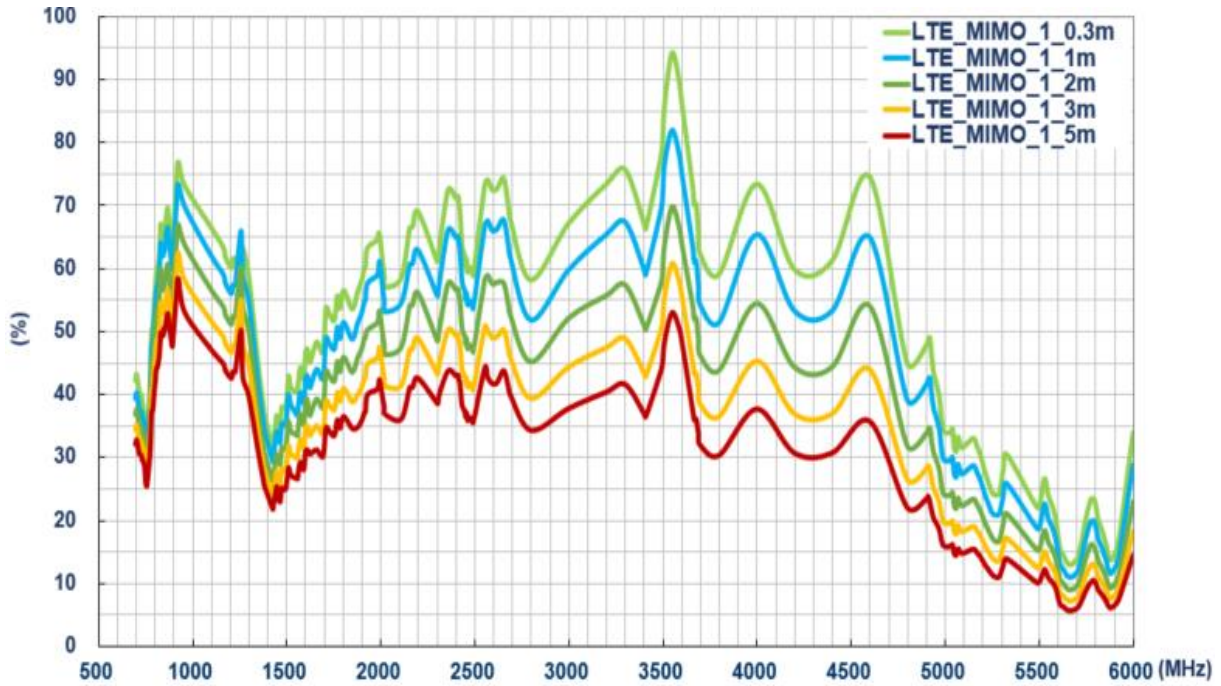

### Efficiency – LTE MIMO2 Antenna (On 30\*30cm GND)

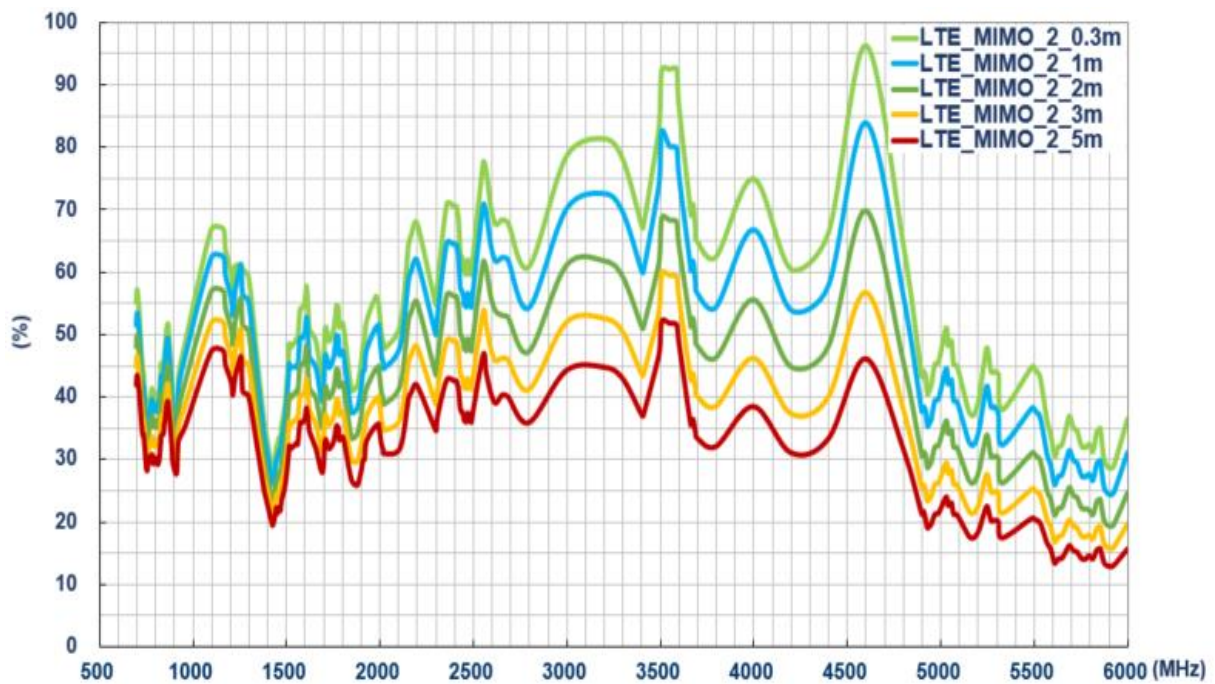



**Efficiency – WI-FI MIMO1 Antenna (On 30\*30cm GND)**

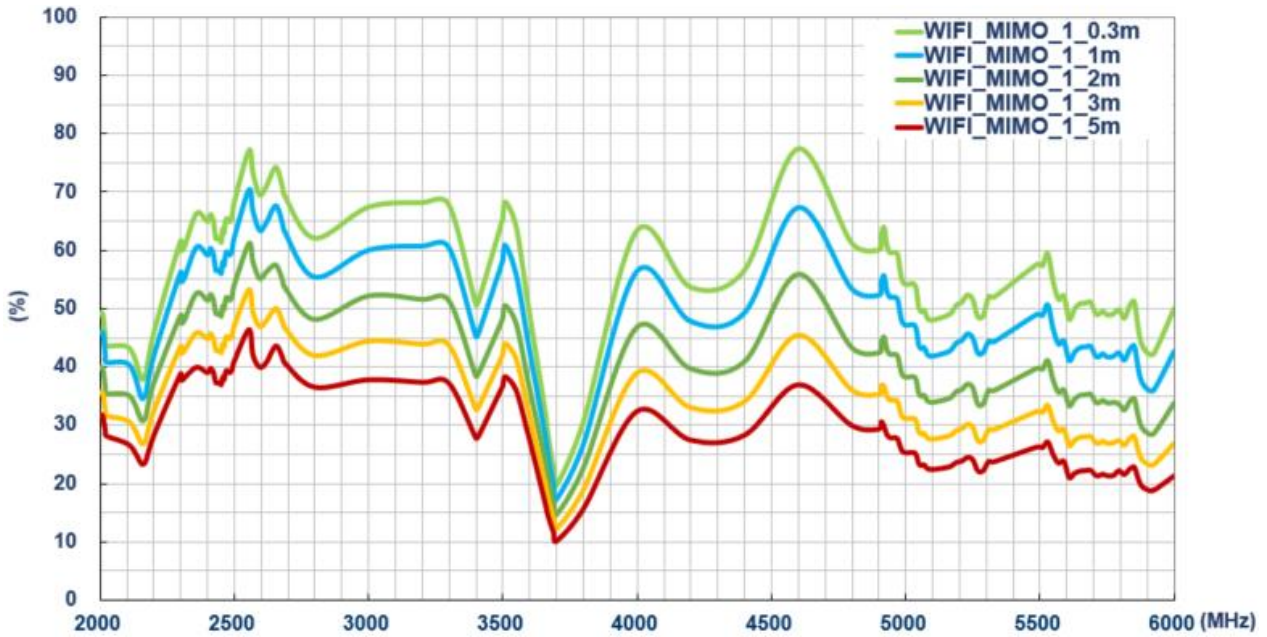

**Efficiency – WI-FI MIMO2 Antenna (On 30\*30cm GND)**

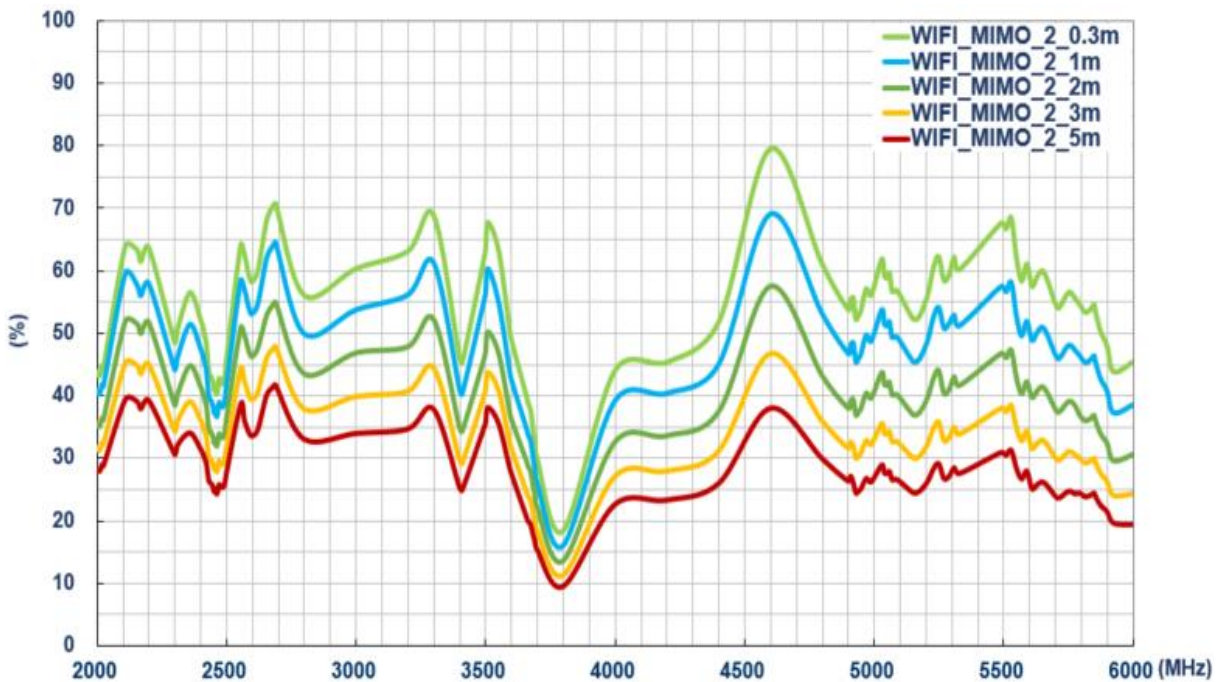

### 7.3. Average Gain

#### Average Gain – LTE MIMO1 Antenna (On 30\*30cm GND)

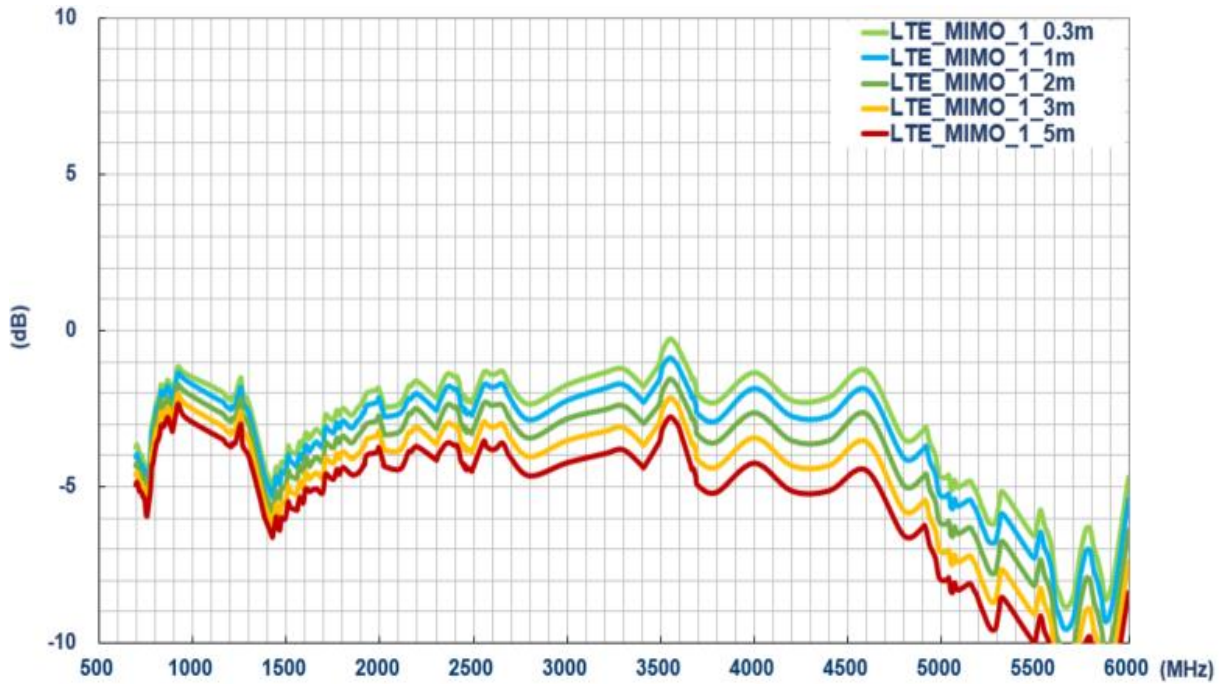

#### Average Gain – LTE MIMO2 Antenna (On 30\*30cm GND)

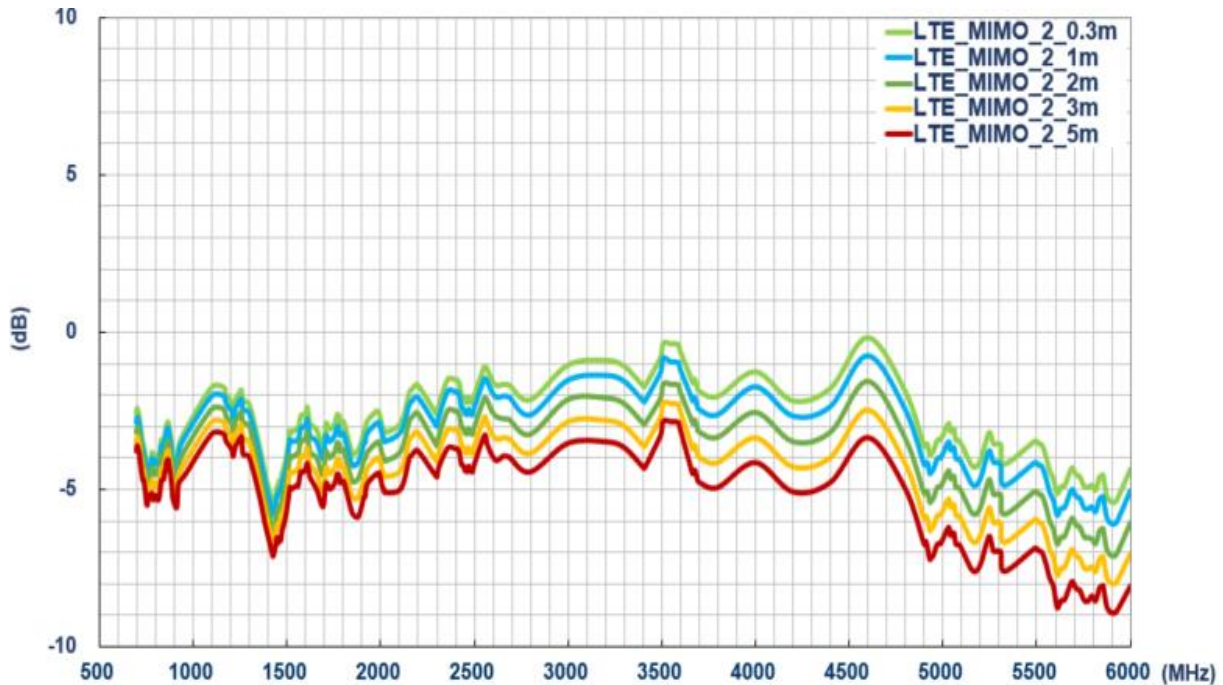

**Average Gain – WI-FI MIMO1 Antenna (On 30\*30cm GND)**

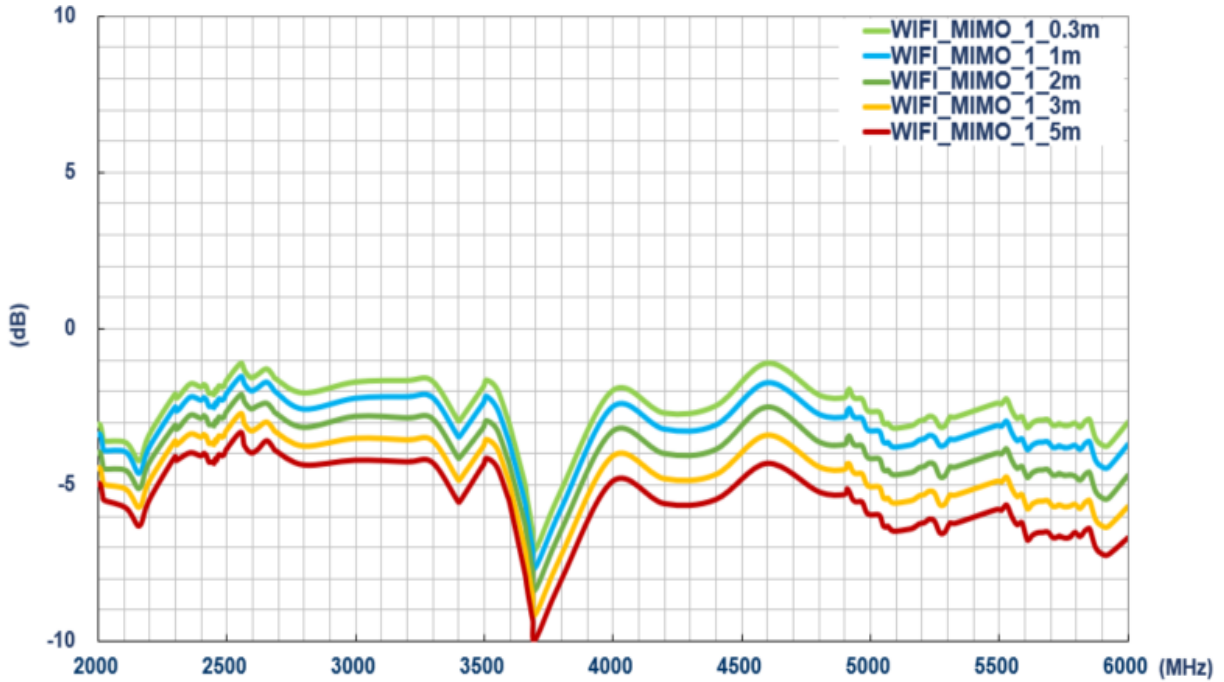

**Average Gain – WI-FI MIMO2 Antenna (On 30\*30cm GND)**

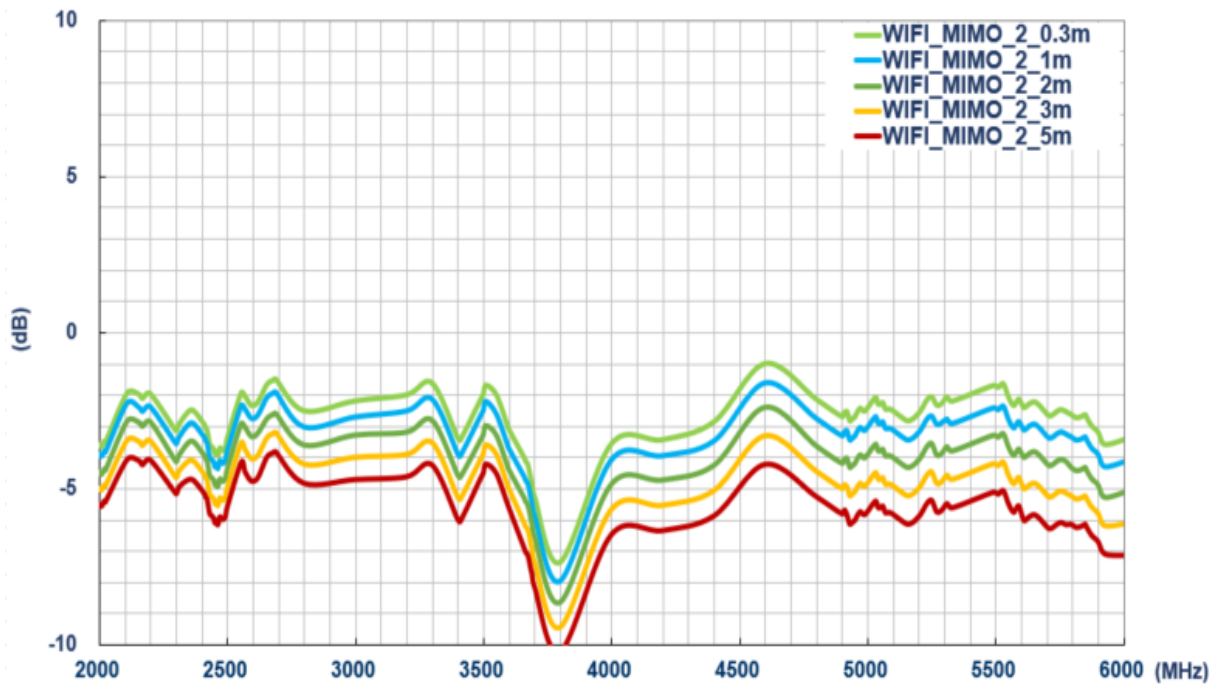

## 7.4. Peak Gain

### Peak Gain – LTE MIMO1 Antenna (On 30\*30cm GND)

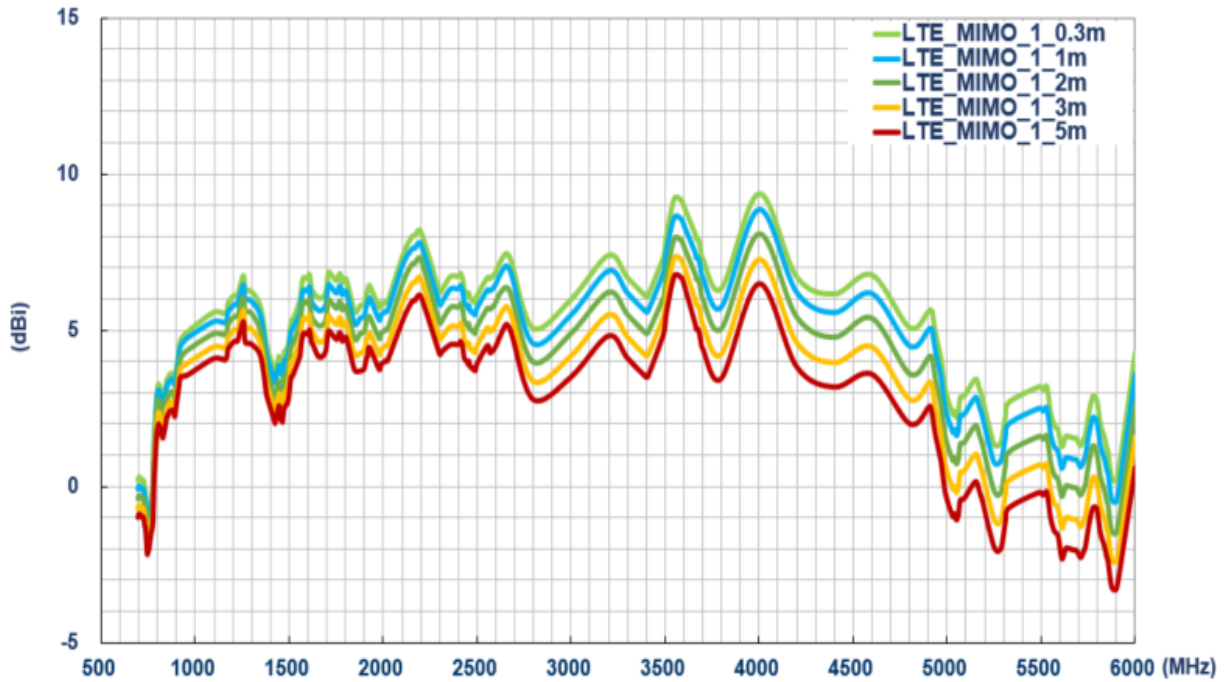

### Peak Gain – LTE MIMO2 Antenna (On 30\*30cm GND)

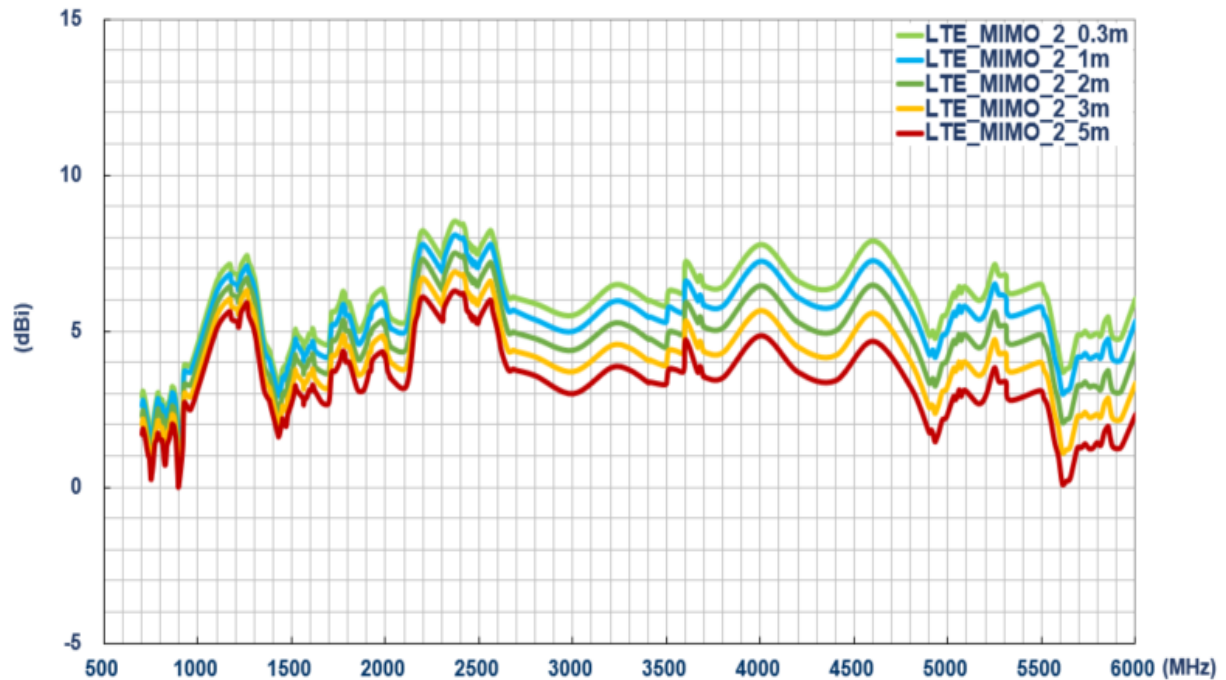

**Peak Gain – WI-FI MIMO1 Antenna (On 30\*30cm GND)**

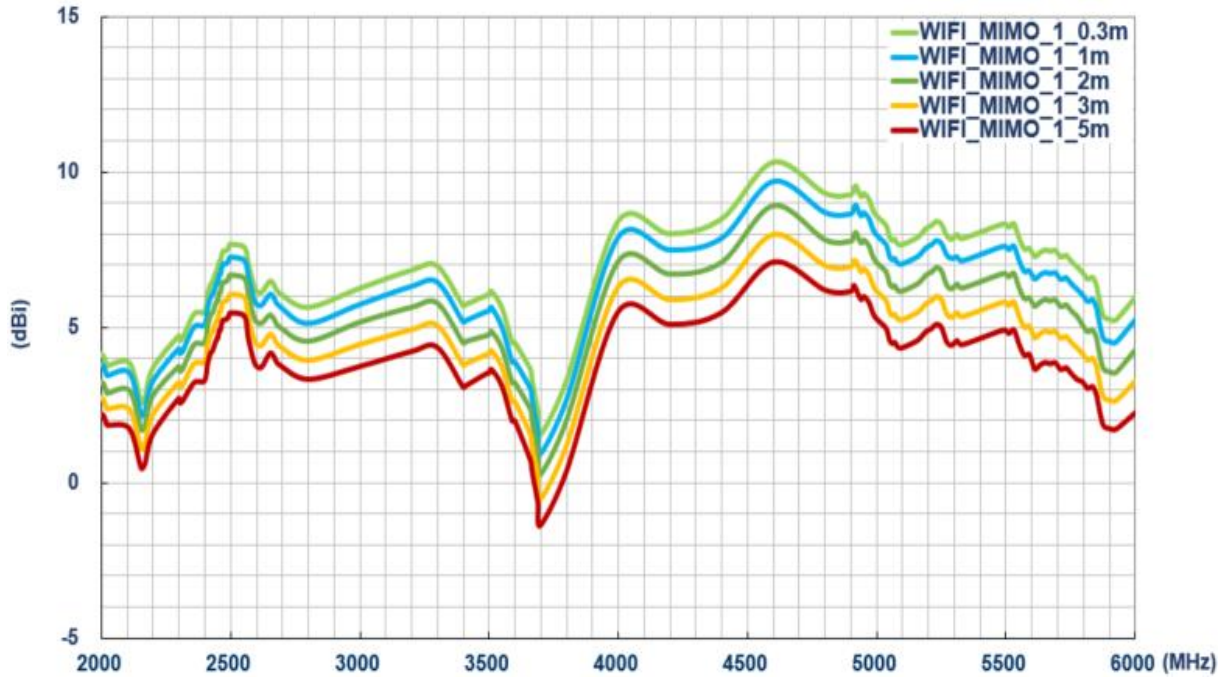

**Peak Gain – WI-FI MIMO2 Antenna (On 30\*30cm GND)**

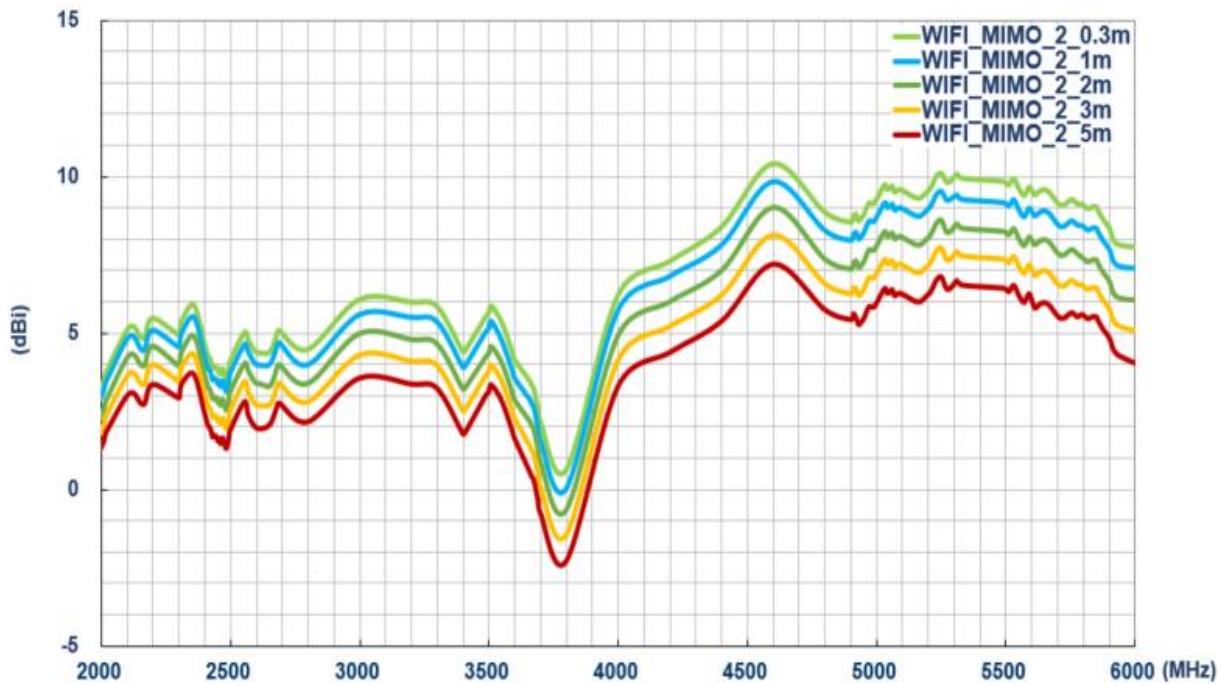

Taoglas makes no warranties based on the accuracy or completeness of the contents of this document and reserves the right to make changes to specifications and product descriptions at any time without notice. Taoglas reserves all rights to this document and the information contained herein.

Reproduction, use or disclosure to third parties without express permission is strictly prohibited.

Copyright © Taoglas Ltd.