

SPECIFICATION

- Part No: **GPDF.47.8.A.02**
- Product Name: Embedded 47.5*47.5*8mm GPS L1/L2 / GALILEO Low Profile Stacked Antenna
- Features: Highest Accuracy, Lowest Profile Low Axial Ratio
Wideband GNSS Antenna
GPS L1+L2 Band Operation
Dual Feed Patch Assembly - use with Hybrid Couplers
L1:1575MHz; Axial Ratio 1.9 @1575.42 MHz
L2:1227MHz Axial Ratio 2.19@1227.6MHz
47.7*47.7*8mm
Tuned for Centre Positioning on a 70*70mm Ground-plane
Through-Hole Mounting Pin Type
RoHS Compliant



1. Introduction

The GPDF.47.8.A.02 is a 47.5*47.5mm ceramic GPS L1/L2 / GALILEO low profile, low axial ratio, embedded stacked passive patch antenna with 8mm thickness. It is designed for highest accuracy centimeter level tracking in telematics applications for positioning technologies. Typical applicable industries are transportation, defense, marine, agriculture, and navigation.

This antenna exhibits excellent gain and radiation pattern stability on both L1 and L2 bands, which leads to improved reliability of a GPS fix in areas where signal strength is poor, along with higher accuracy positioning when used to support ionosphere error correction algorithms.

The antenna has been tuned and tested on a 70*70mm ground plane, working at GPS 1575.42MHz and L2 1227.6MHz, with 4.23dBi gain and 0.04dBi gain, respectively. It can be easily through-hole mounted on PCB via pin. The double-sided adhesive on the bottom of the patch helps to keep it in place while undergoing mounting.

To implement the GPDF.47A dual band L1+L2 dual-feed patch antennas, the antenna ideally needs to be placed centrally on a 70*70mm ground-plane. Each band pair should be fed with a hybrid coupler (reference Anaren XC1400P-03S, link as follows: www.anaren.com/sites/default/files/XC1400P-03%20Data%20Sheet%20Rev%20C.pdf)

All feed lines need to be 50 ohm transmission lines.

For more details, please refer pages 13 for PCB footprint and application recommendation.

For further optimization to customer specific device environments, a custom tuned patch antenna and circuit integration service into your device can be supplied, subject to NRE and MOQ. Contact your regional Taoglas office for this requirement, and for support to integrate and test this antenna's performance in your device.

2. Specification

ELECTRICAL				
	GPS L1/GALILEO		GPS L2	
Center Frequency	1575.42 MHz		1227.6 MHz	
Return loss (dB) Through Pin	Port 1	Port 2	Port 1	Port2
	-17.77	-16.11	-25.06	-28.53
Return loss (dB) Through Coupler	-15		-22	
Efficiency (%)	67.98		33.92	
Peak Gain (dBi)	4.23		0.04	
Axial Ratio at Zenith	1.90		2.19	
Impedance	50 Ohm			
Hybrid Coupler XC1400P-03S	Frequency	Isolation	Insertion loss	VSWR
	1215-1240	23	0.23	1.17
	1563-1588	23	0.32	1.20
Polarization	RHCP (include coupler)			

MECHANICAL		
	GPS L1	GPS L2
Ceramic Dimension	41.3*41.3*4mm	47.7*47.7*4mm
Pin Diameter	0.85mm	
Pin Length	1.55mm	
PCB Dimension	70*70mm	
Weight	45g	

ENVIRONMENTAL	
Operation Temperature	-40°C to 85°C
Humidity	Non-condensing 65°C 95% RH

Tested on square 70*70 mm ground-plane.

3. Antenna Characteristics

3.1 Return loss without Hybrid Coupler

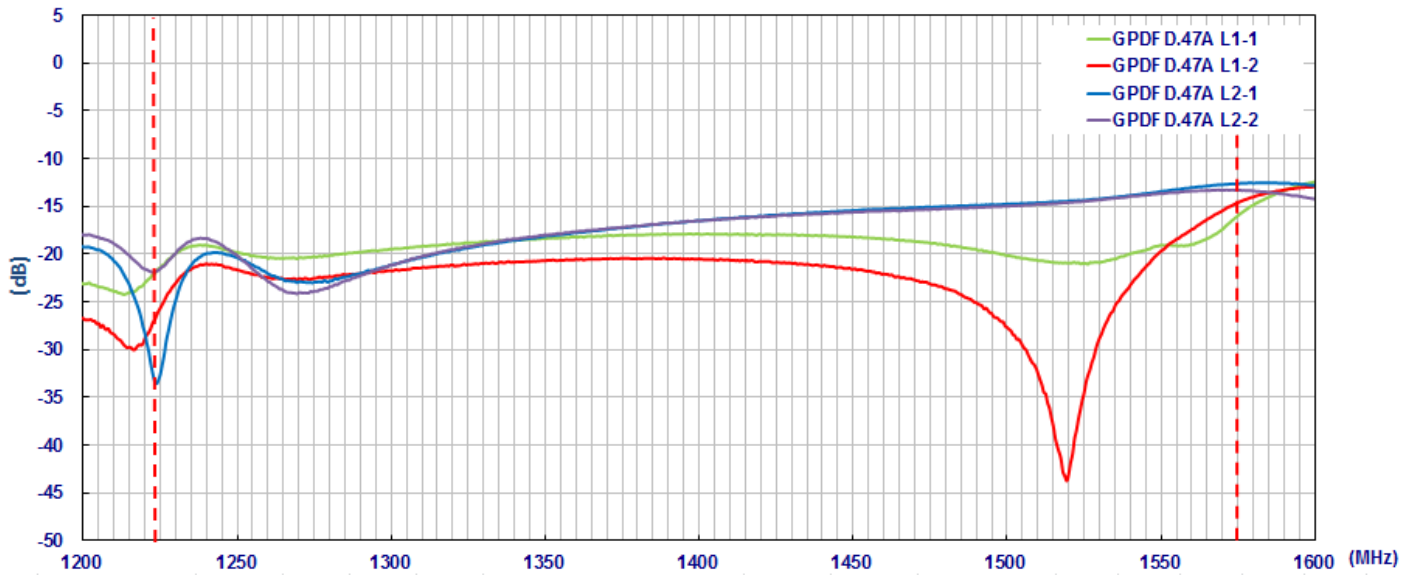

3.2 Efficiency

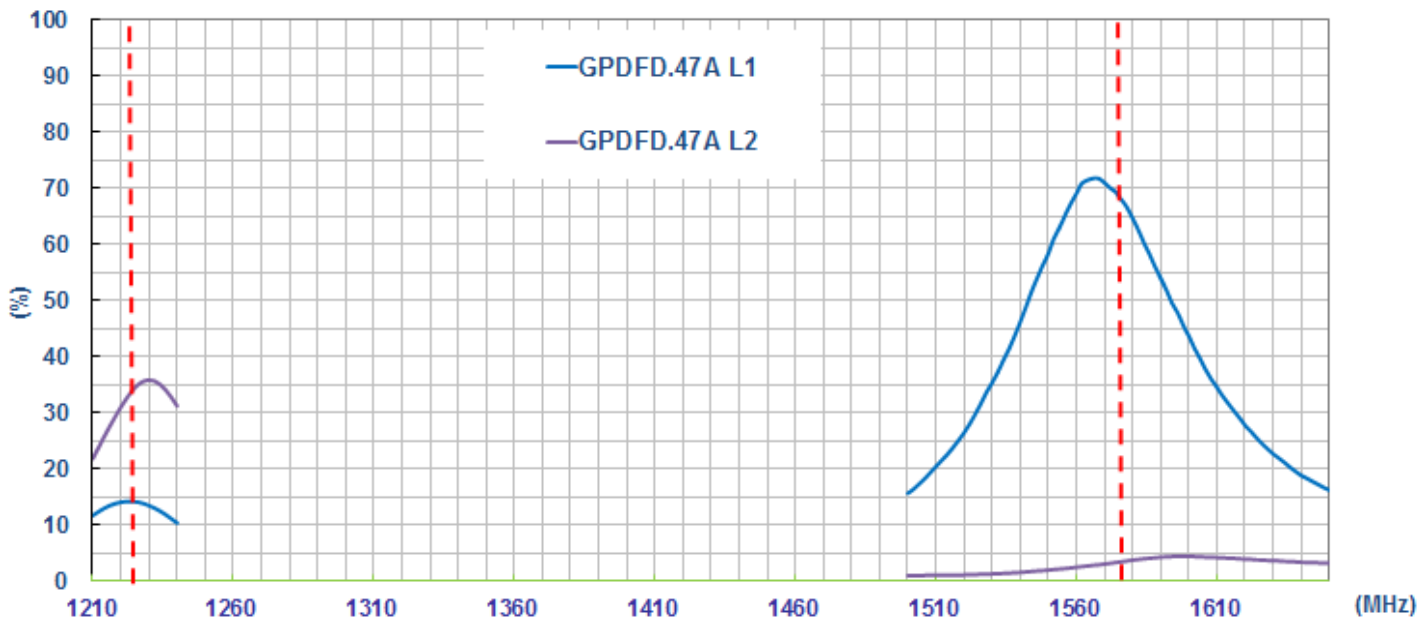

3.3 Peak Gain

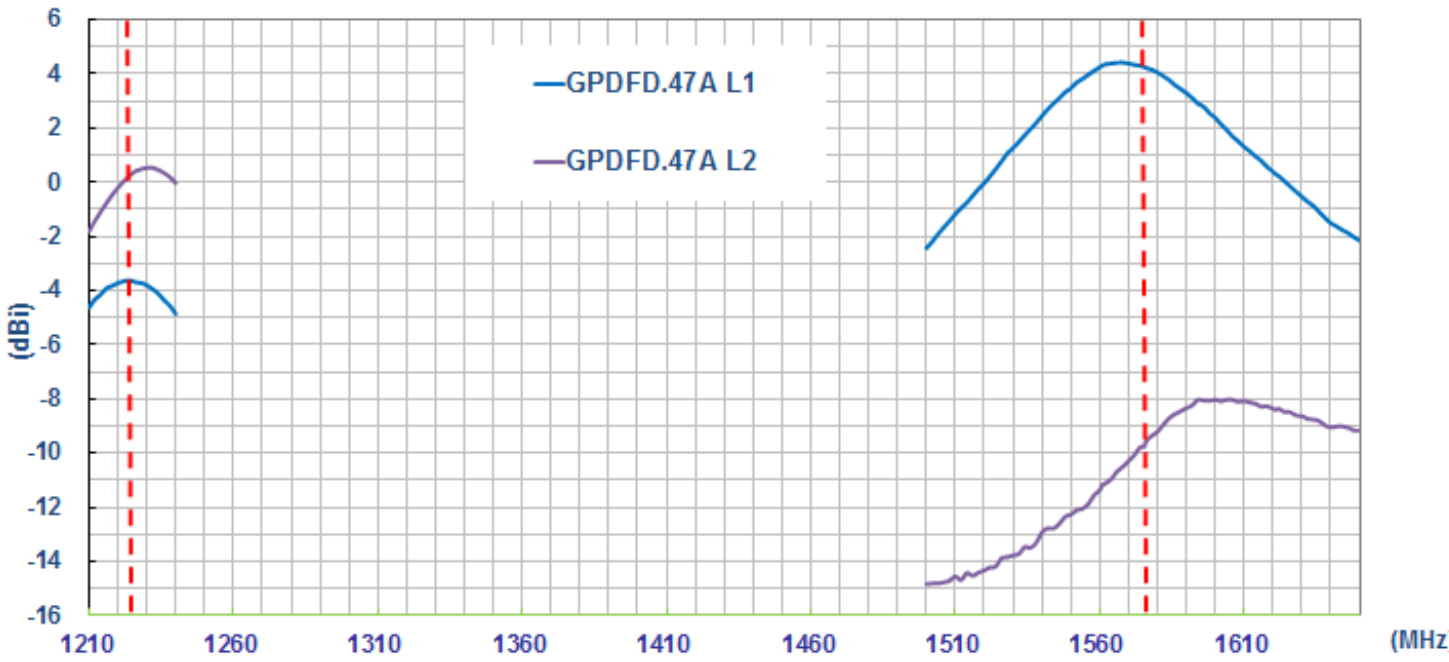

4. Axial Ratio

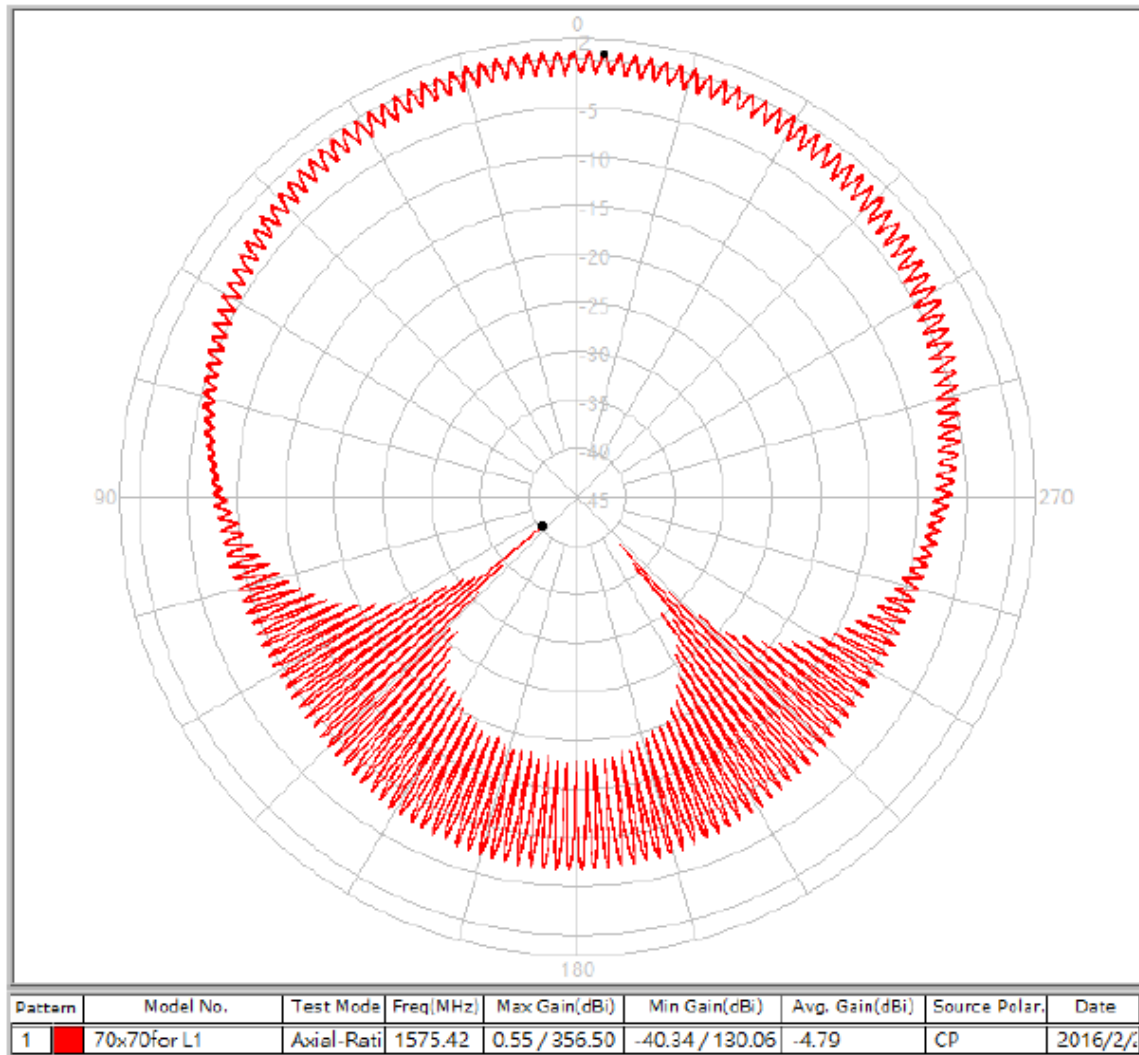

L1 : 1575.42MHz

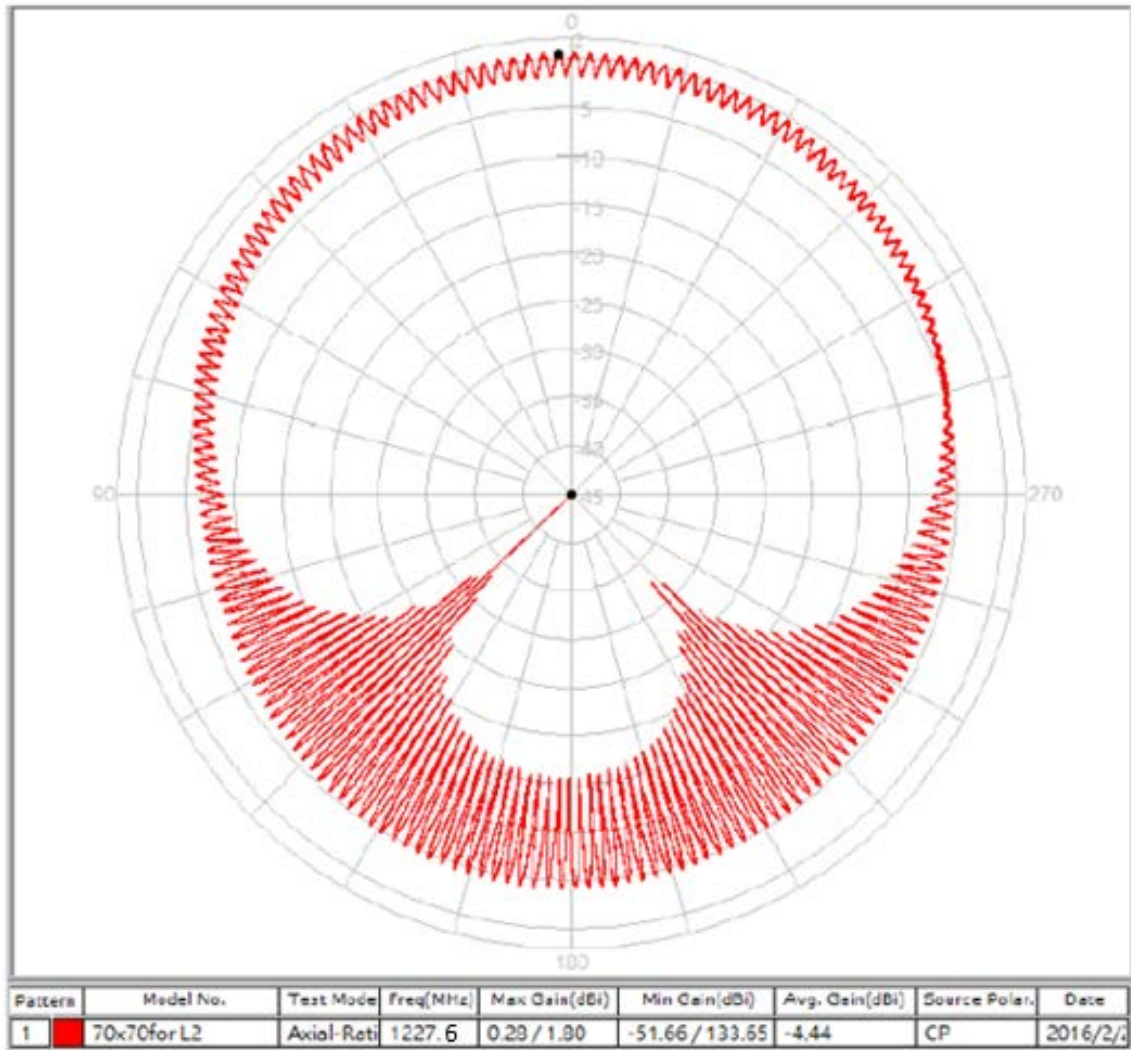

L2 : 1227.60MHz

5. Antenna Radiation Pattern

5.1 Measurement Setup

The GPDF.47.8.A.02 antenna is tested in free-space on a 70*70mm ground plane in an Anechoic Chamber. The test setup is shown below.

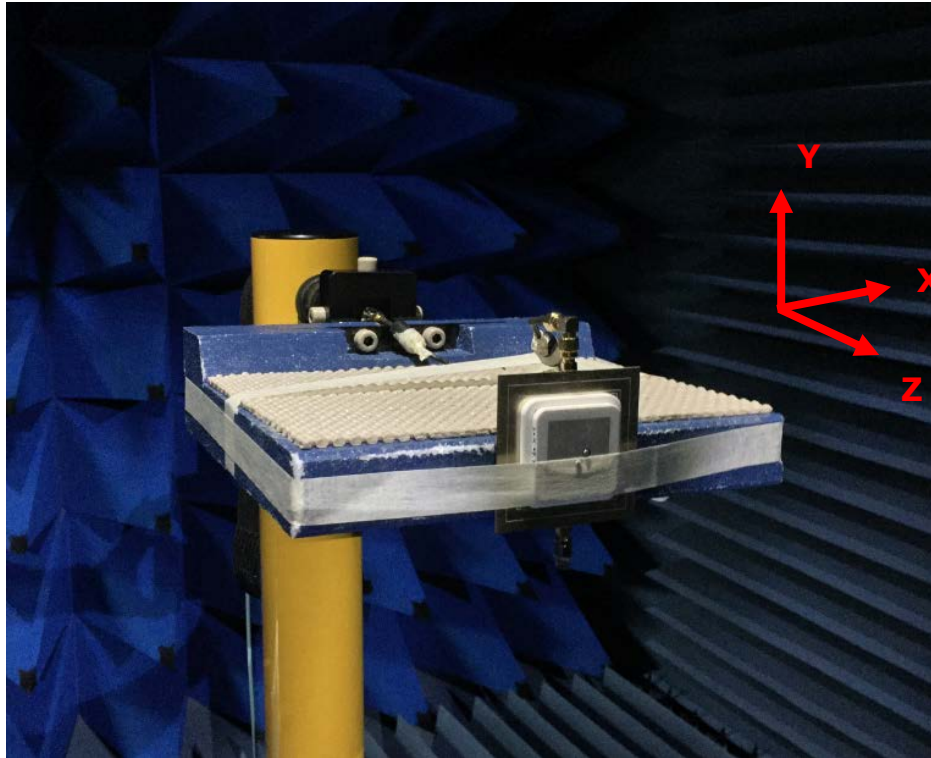

5.2 2D Radiation Pattern

XY Plane

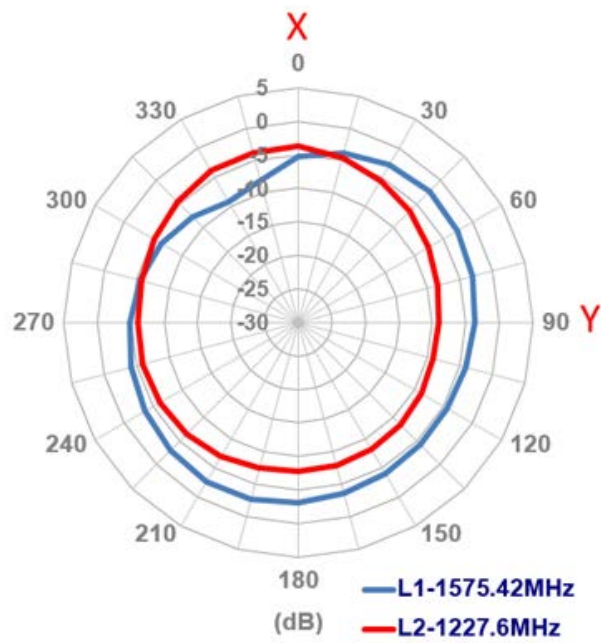

XZ Plane

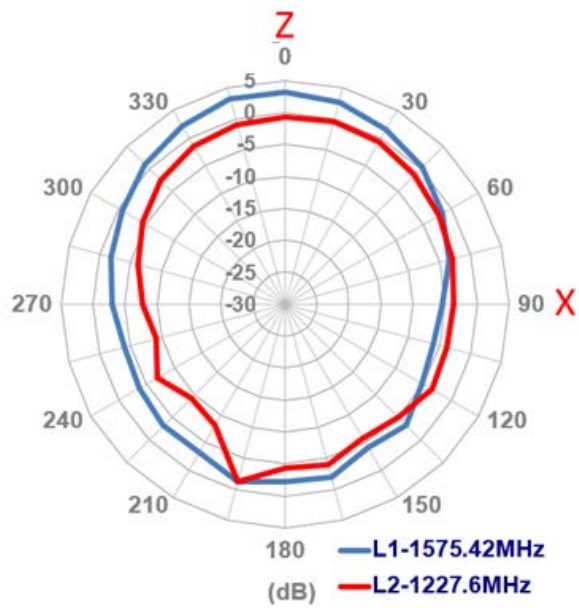

YZ Plane

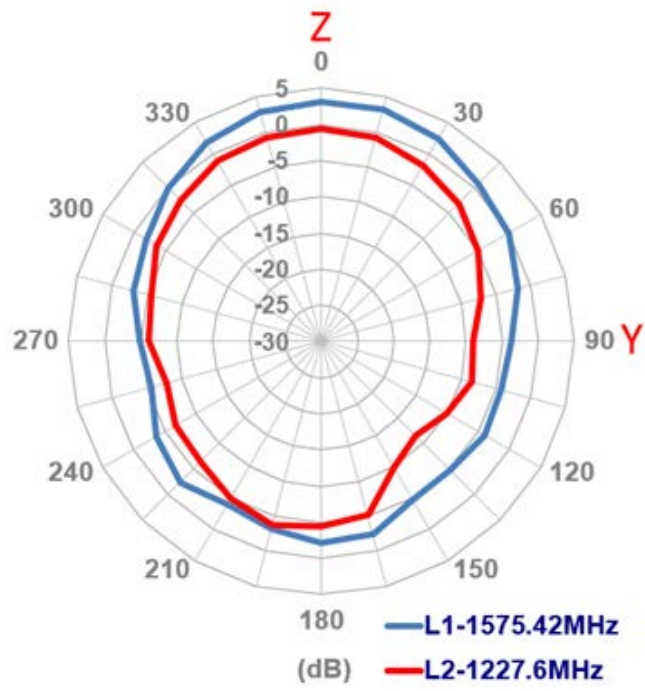

5.3 3D Radiation Pattern

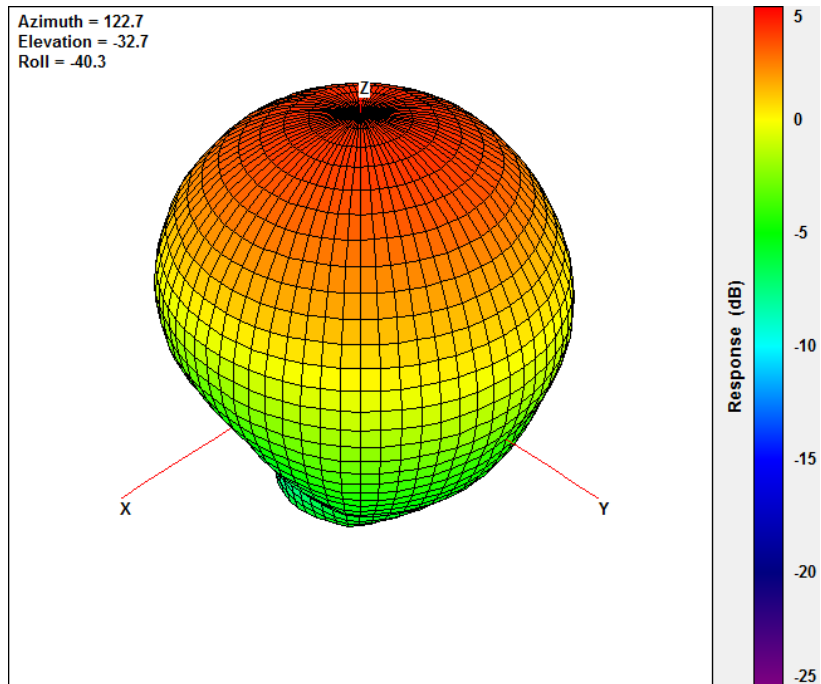

GPS L1 Band at 1575.42MHz

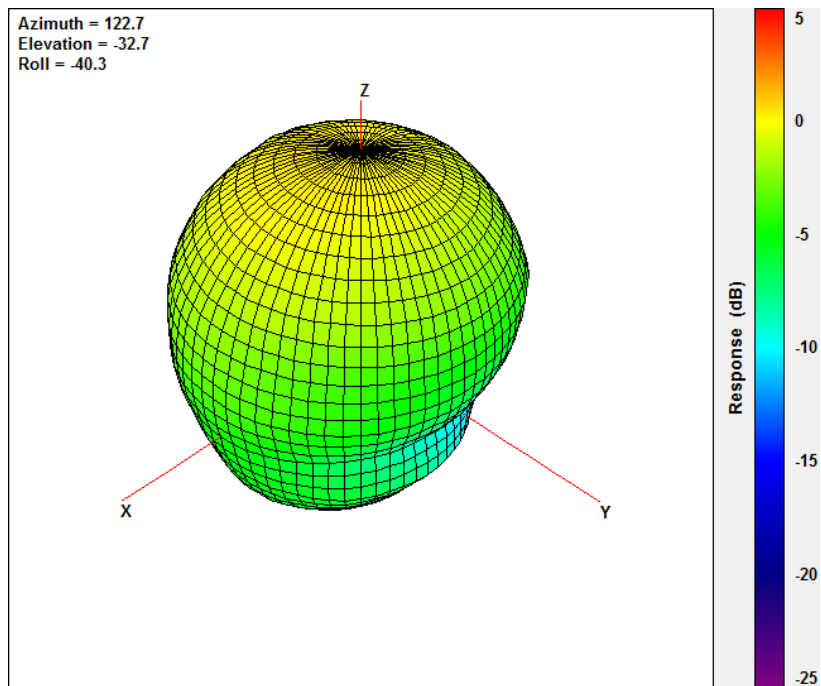

GPS L2 Band at 1226.7MHz

6. Mechanical Drawing (Unit: mm)

6.1 GPDF.47.8.A.02

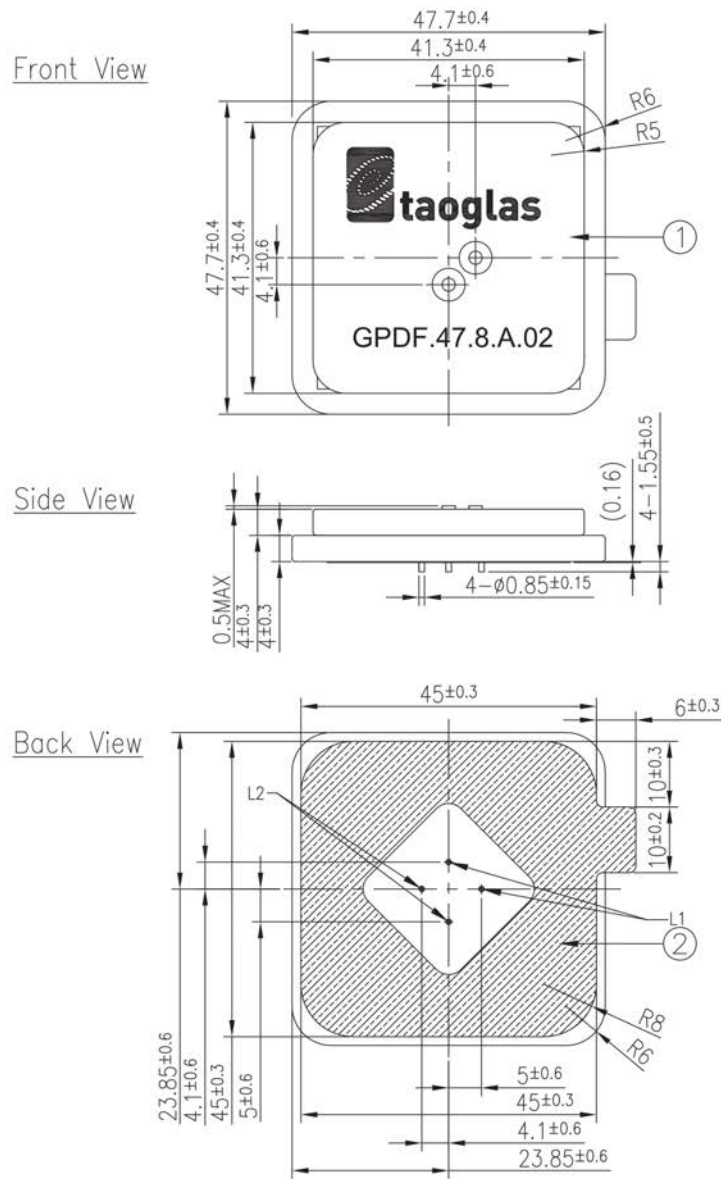

	Name	Material	Finish	QTY
1	GPDF.47 Patch	Ceramic	Clear	1
2	Double sided Adhesive	NITTO 5000NS	White Liner	1

6.2 GPDFD.47.A Evaluation Board

Front View

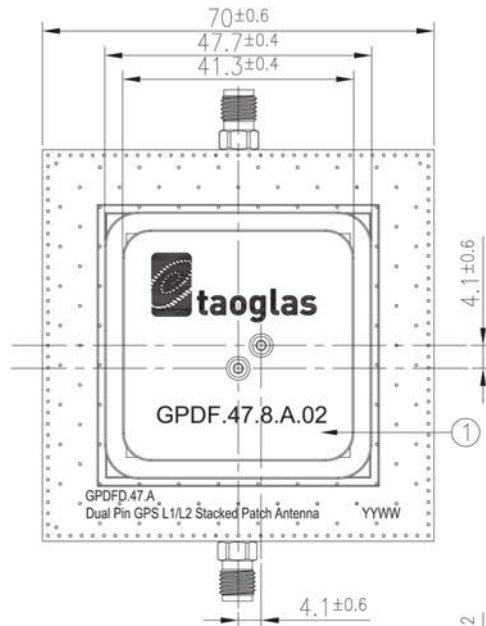

Side View

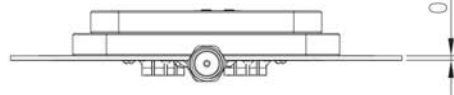

Back View

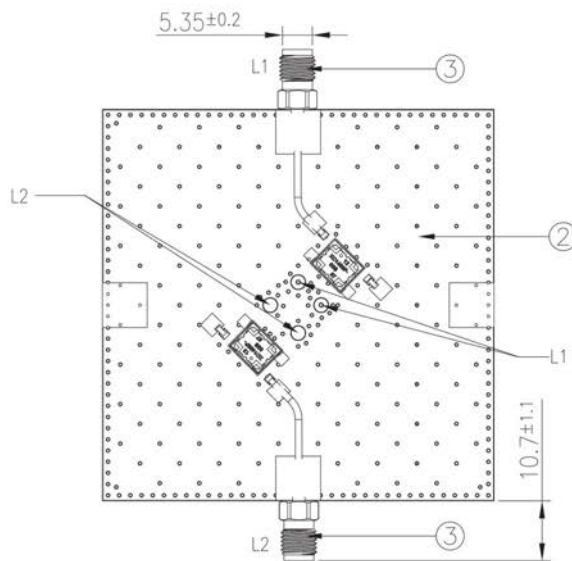

Name	Material	Finish	QTY
1 GPDF.47.8.A.02 Patch(47x47x8)	Ceramic	Clear	1
2 Ground-Plane(70x70x0.8mm)	Brass	Silver	1
3 SMA(F)ST	Brass	Au Plated	2

7. PCB Footprint & Application Recommendations

Traditional single-pin GPS patch antennas generate circular polarization by creating two orthogonal field modes within the patch, one lagging in phase by 90° compared to the other. These orthogonal modes are created by a number of means, including chamfering the patch and offsetting the feed (pin) location. This function provides an excellent axial ratio (a measure of circular polarization purity), but the axial ratio bandwidth tends to be lower than the impedance or efficiency bandwidth of the antenna.

Dual-feed patch antennas, on the other hand, create circular polarization through what is perhaps a more straightforward approach. Rather than using the aforementioned techniques to create the required orthogonal modes, two separate feeds are instead used. Each feed creates a mode, and the feeds are placed such that the modes are orthogonal. A 90° phase shift is applied externally to one feed to fully realize circular polarization.

The advantage of this dual-feed structure is that the axial ratio bandwidth tends to be much wider than for a comparable single-feed patch. This can yield improvements in interference and multipath rejection for GLONASS and BeiDou, and be more resilient to detuning the axial ratio.

The GPDF.47.A dual-band L1+L2 dual-feed patch antennas are created to realize these benefits. However, there are a few key items to control when it comes to verifying the implementation of this antenna:

1. **Ground plane:** The antenna needs to be placed on at least a 50*50mm ground plane.
2. **Placement:** Center the antenna on the ground plane to minimize detuning.
3. **Feeding:** The antenna uses four feed pins, two for each band (L1 and L2). Each band pair should be fed with a hybrid coupler (Anaren XC1400P-03S) as shown below.
4. **Transmission Lines:** All feed lines need to be 50 ohm transmission lines. Microstrip or Grounded Coplanar Waveguide (CPW-Ground) should be used.

The footprint and reference layout are provided in the figures 2 and 3, respectively. These connections are shown schematically in Figure 1. A bill of material is presented below in Table 1.

It is critical to match the trace lengths of the 0°/90° feeds for each band, within a +/-0.5mm tolerance. The feed lengths between bands do not need to be matched. For example, the trace length between L1-0° and X1 pin 1 needs to be the same length (within +/-0.5mm) as the trace length between L1-90° and X1 pin 2. But the trace length between L1-0° and X1 pin 1 does not need to be the same as the trace length between L2-0° and X2 pin 1.

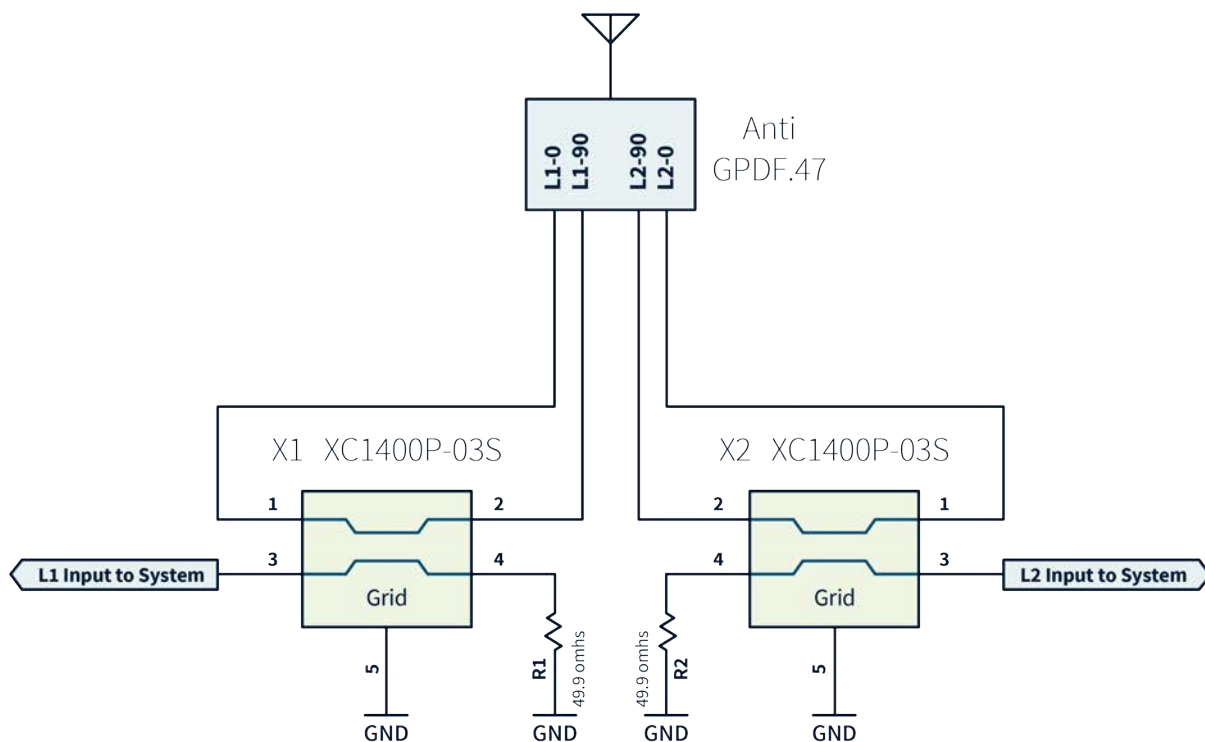

Figure 1. Schematic representation of GPDF.47.8.A.02 feed network. The pin numbers of hybrid couplers X1 and X2 follow the manufacturer's datasheet reference.

DESIGNATORS	DESCRIPTION	MANUFACTURER	PART NUMBER	QUANTITY
X1, X2	3dB 90° Hybrid Coupler, GPS L1/L2	Anaren	XC1400P-03S	2
R1, R2	Resistor, 49.9 ohm, 1% , 0402 or 0603	Multiple	Multiple	2
ANT1	L1+L2 dual-feed stacked patches	Taoglas	GPDF.47.8.A.02	1

Table 1. Bill of Material for schematic in Figure 1.

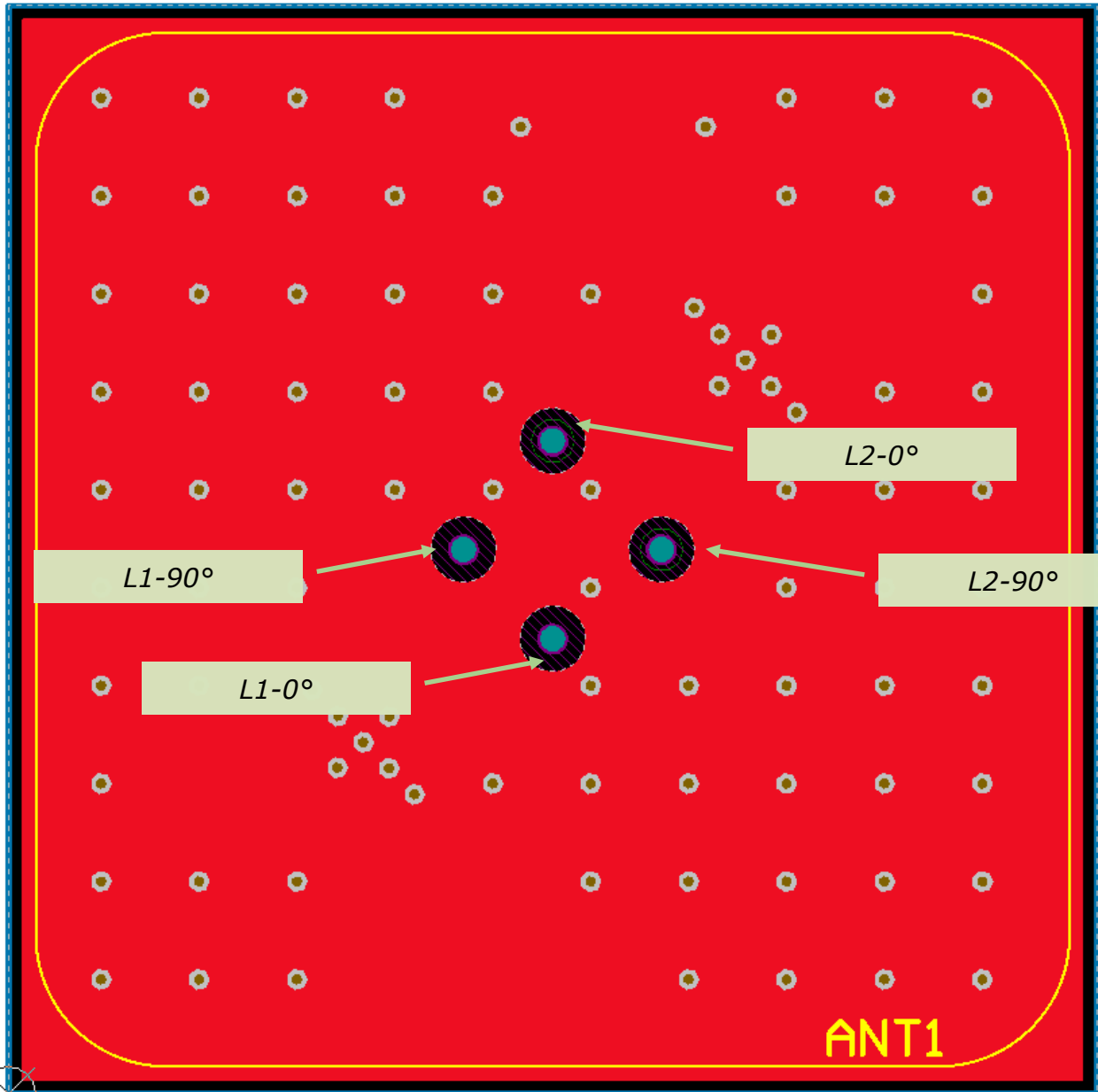

Figure 2. 50*50mm reference board, top view

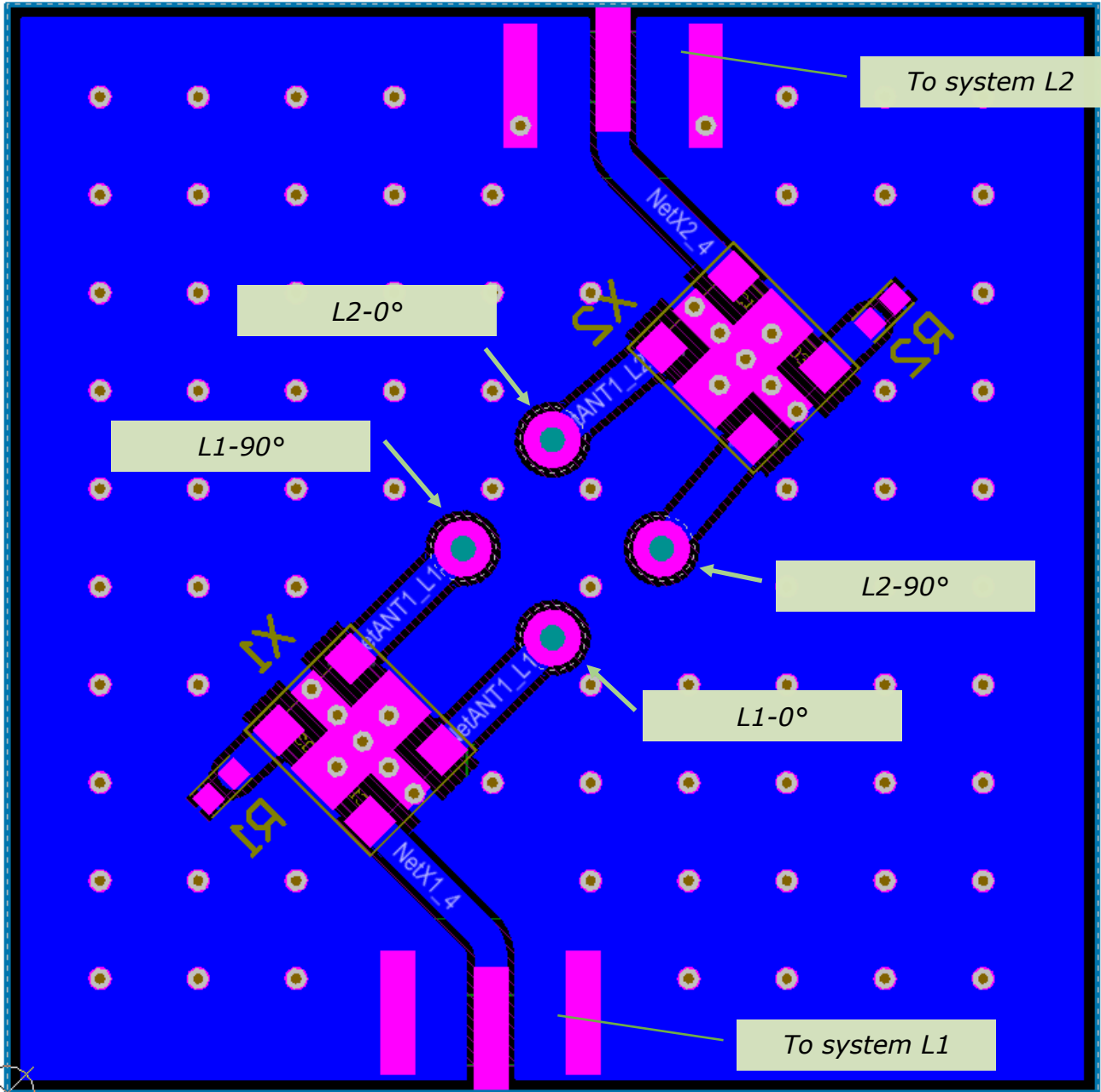
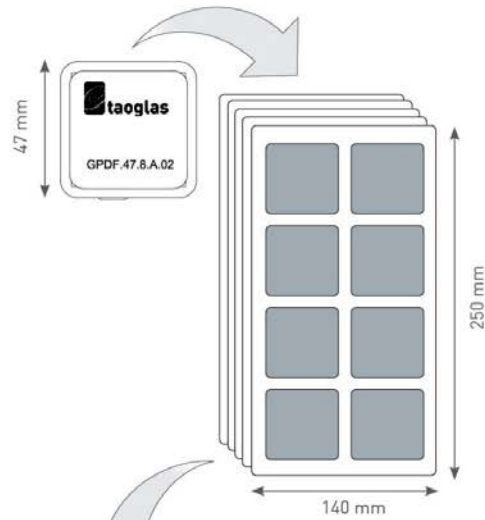

Figure 3. 50*50mm reference board, bottom view

8. Packaging

8 pcs GDPF.47.8.A.02 per tray
 Tray Dimensions - 250*140mm
 Weight - 360g



40 pcs GDPF.47.8.A.02 per Inner Carton
 Inner Carton Dimensions - 263*154*96mm
 Weight - 2.4kg

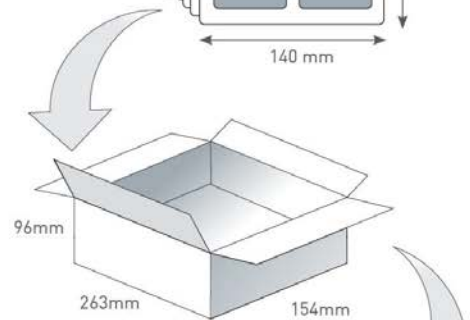

160 pcs GDPF.47.8.A.02 per Carton
 Carton Dimensions - 327*280*218mm
 Weight - 9kg

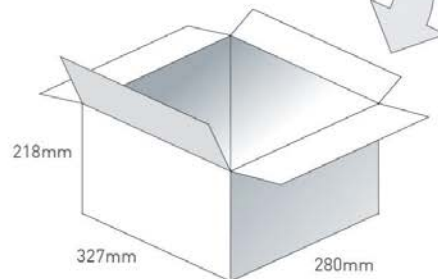

Pallet Dimensions 1120*990*1470mm
 72 Cartons per Pallet
 6 Cartons per layer
 12 Layers

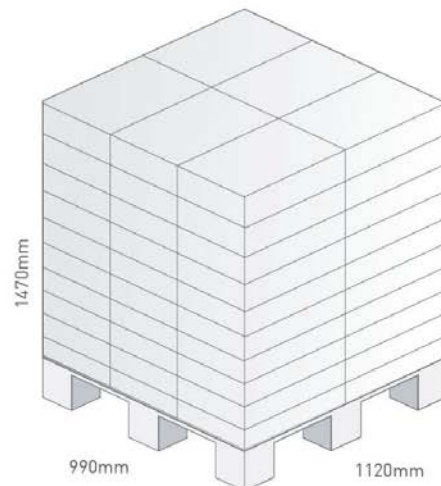

Taoglas makes no warranties based on the accuracy or completeness of the contents of this document and reserves the right to make changes to specifications and product descriptions at any time without notice. Taoglas reserves all rights to this document and the information contained herein.

Reproduction, use or disclosure to third parties without express permission is strictly prohibited.

Copyright © Taoglas